

Evaluative Bibliometrics

THE USE OF PUBLICATION AND CITATION ANALYSIS IN THE EVALUATION OF SCIENTIFIC ACTIVITY

FRANCIS NARIN

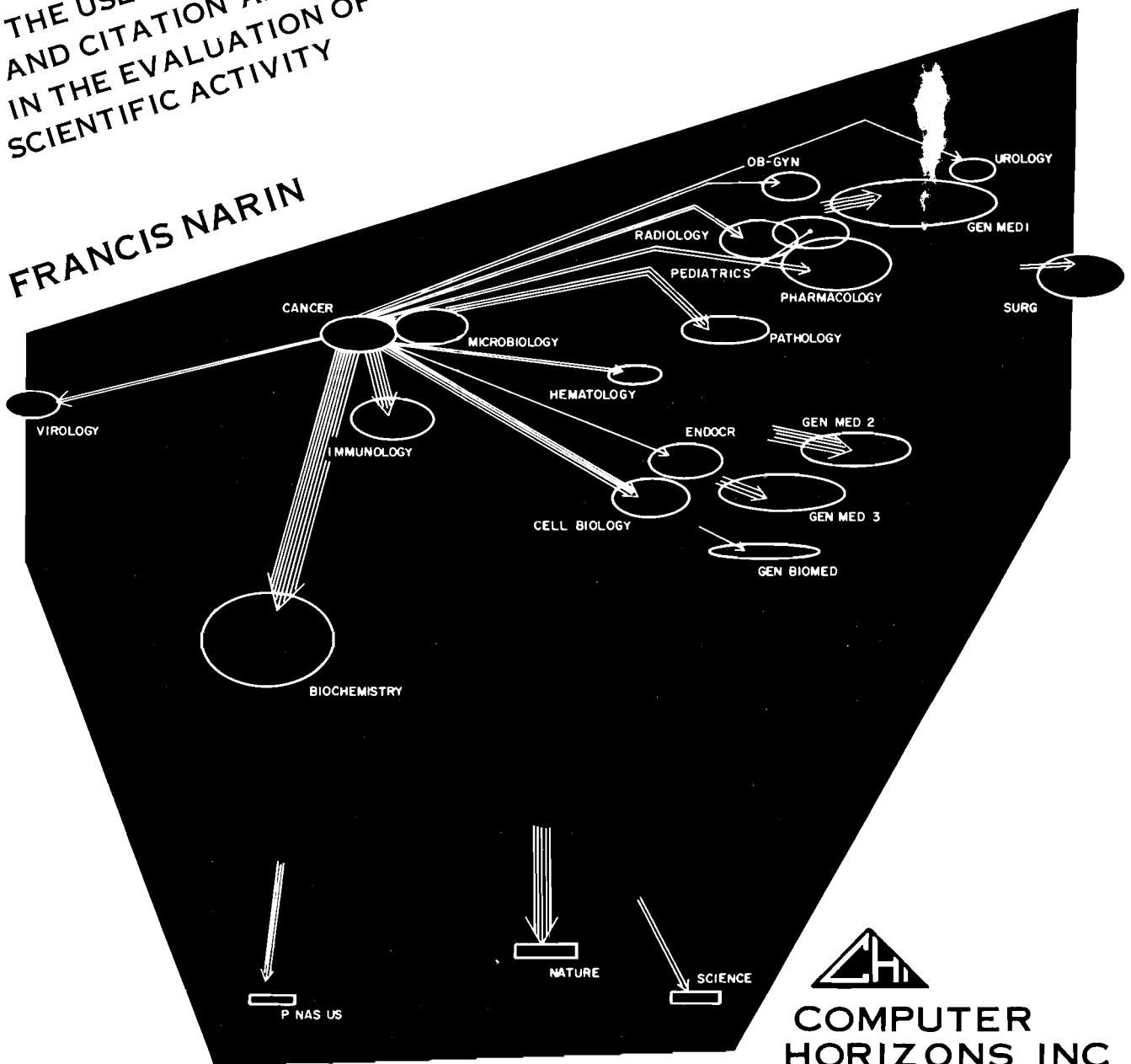

COMPUTER
HORIZONS, INC.

EVALUATIVE BIBLIOMETRICS:
THE USE OF PUBLICATION AND CITATION ANALYSIS
IN THE EVALUATION OF SCIENTIFIC ACTIVITY

Prepared by

Francis Narin

and the staff of

COMPUTER HORIZONS, INC.
1050 Kings Highway North
Cherry Hill, New Jersey 08034

Phone 609/779-0911

In Fulfillment of Contract NSF C-627
with the
NATIONAL SCIENCE FOUNDATION
1800 G Street, N.W.
Washington, D.C. 20550

Computer Horizons, Inc. Project No. 704R

March 31, 1976

FOREWORD

This monograph is the last report under Contract NSF-C627, between the National Science Foundation and Computer Horizons, Inc. of Cherry Hill, New Jersey. This report should acquaint the reader with the development of evaluative bibliometrics as a tool for research assessment. It should also serve as a reference source for current evaluative applications.

At the outset of the project in July of 1970, the contract objective was to explore the possibility of generating importance and utilization measures by citation indexing of 250 journals in the physical sciences. In the ensuing 5 years this basic component of the work has evolved into a rigorous procedure for the calculation of citation influence covering nearly 2,000 journals, 9 major fields and 100 subfields of science. The influence data and procedures comprise Chapters VII through X of this report.

In addition to providing citation influence data, this monograph also summarizes the general state-of-the-art of publication-and-citation-based evaluation. This summary, contained in Chapters I through VI, covers the applied tasks of general interest under Contract NSF-C627, as well as the predecessor and related work of other scientists. The publication and citation techniques will be shown to be effective evaluative tools, in general accord with intuitive expectations.

At many points in the text where the work of other scientists is mentioned, a table or figure has been included to acquaint the reader with the basic works in the field. These tables and figures have been inserted so that readers will not have to refer back to the original papers, which are scattered over many years and a wide variety of disciplinary literatures.

Normally, the results of publication and citation analysis are clearly evident. Institutions and countries and other aggregates of scientists differ from one another by factors of two or more in publication size, in citation rates, in subject emphasis or in other publication or citation based measures. Bibliometric indicators usually correlate highly with the intuitive notions of knowledgeable scientists.

Through the perusal of this monograph it is hoped that the reader will gain substantial insight into the techniques used in evaluative bibliometrics, into the power and limitations of these techniques, and into how they may be applied to the assessment of scientific activities.

ACKNOWLEDGMENT

Much of the work reported in this monograph has been performed by the staff of Computer Horizons, Inc. over the last 5 years. Certain contributions are well enough defined to be recognized individually.

The eigenvalue formulation of journal influence, its implementation, computation, and mapping are largely the work of Dr. Gabriel Pinski, Research Advisor at Computer Horizons, Inc.

Much of the work in the international area has been done by Mark P. Carpenter, Staff Analyst at Computer Horizons, Inc. Mr. Carpenter also developed the cluster analysis techniques.

The statistical reliability formulation in Chapter IX is the work of Richard C. Anderson, Senior Analyst at Computer Horizons, Inc.

Daniel Garside and Mark P. Carpenter made substantial contributions to the development of the two-step and hierarchical maps, and to other techniques developed in the early stages of this contract.

J. Davidson Frame, Staff Analyst and S.B. Keith, Associate Analyst performed the analytical and computational tasks related to the biomedical publication section of Chapter VI.

Specific thanks are due to Dr. Bodo Bartocha, now Director, Division of International Programs, National Science Foundation, who was instrumental in the initiation of this contract.

Special thanks are also due to Messrs. Emanuel Haynes and Harry Picarriello at the National Science Foundation, who have been NSF project officers for the majority of the contract.

In a related study for the National Institutes of Health (Contract N01-OD-3-2109), Computer Horizons has been analyzing the relationship between biomedical funding and the publications of major NIH grantee organizations. The biomedical journal classification and influence computations, which are included in this report, were performed under that contract. Dr. Helen H. Gee is the NIH project officer.

Finally, thanks are due to Dr. Joy K. Moll, Staff Analyst at Computer Horizons, Inc. for assistance in editing this monograph and to Eleanor S. Davis for its typing and preparation.

A complete list of the reports and papers written under Contract NSF-C627 is contained in Chapter XI.

Francis Narin
President, Computer Horizons, Inc.
Principal Investigator, Contract NSF-C627

TABLE OF CONTENTS

CHAPTER		PAGE
I.	INTRODUCTION	1
	A. An Overview of Publication and Citation Analysis	
	B. Structure of the Monograph	
II.	SIZE OF THE SCIENTIFIC ENTERPRISE	8
III.	STRUCTURE OF THE SCIENTIFIC LITERATURE	40
IV.	SCIENTIFIC PRODUCTIVITY	65
v.	CORRELATIONS WITH NON-LITERATURE MEASURES	82
	A. Introduction	82
	B. General Comments on the Twenty-four Studies	83
	C. Descriptions of Individual Studies Comparing Bibliometric and Non-bibliometric Measures	88
	1. Studies Using Correlation Measures	88
	2. Studies Using Other Quantitative Measures	110
	3. Studies Using Qualitative Measures	118
VI.	OPERATIONAL CONSIDERATIONS	122
	A. Basics of Publication and Citation Analysis	122
	1. Type of Publication	122
	2. Time Spans	124
	3. Comprehensiveness of Source Coverage	124
	4. Multiple Authorships and Affiliations	125

TABLE OF CONTENTS
(Continued)

CHAPTER	PAGE
VI.	
5. Completeness of Available Data	126
6. Support Acknowledgements	127
7. Subject Classification	129
8. Citation Counts	129
B. An Example of an Evaluative Bibliometric Analysis	130
1. Selection of Institutions	131
2. Collecting Data on NIH Grants	131
3. Use of R&D Price Deflator	132
4. Concentration of Funding	132
5. Non-NIH Funding	134
6. Data Base for Publications	137
7. Use of Fixed Journal Set	138
8. Data Processing	138
9. Publication Data Problems	140
10. NIH Funds vs. Publication Output: A Cross-Sectional View	141
C. The <u>Science Citation Index</u> as a Publication and Citation Data Base	144
D. Use of the <u>Science Citation Index</u>	152
1. <u>Corporate Index</u> for Institutional Publication Analysis	152
2. <u>Source Index</u> for Individual Publication Analysis	154
3. <u>Citation Index</u> for Citation Analysis	156
4. Special Problems in Citation Analysis on an Individual Author Basis	160
a. Multiple Authorship	160
b. Self-citations	160
c. The Homonym Problem	161
d. Field Variations in Citations	162
e. Short Term Fluctuations	162
f. Cronyism: A Possible Future Problem	163
E. Major Data Bases	163

TABLE OF CONTENTS
(Continued)

CHAPTER		PAGE
VI.		
F.	Field Dependent Characteristics of the Scientific Literature	168
	1. References and Citations	169
	2. Time Distributions and Growth Rates	169
	3. Concentration	175
VII.	THE INFLUENCE METHODOLOGY	183
A.	Introduction	183
B.	Development of the Weighting Scheme	185
	1. The Citation Matrix	185
	2. Influence Weights	186
C.	The Classification Scheme	190
	1. Overview of the Classification Problem	190
	2. Major Fields	195
	3. Biomedical Classification	196
	a. Classification into Subject/Specialty Areas	196
	b. Classification into Research Levels	198
	4. Linking Areas	199
	5. Multidisciplinary Journals	203
D.	Hierarchies of Journals	203
E.	Application to Physics Journals	206

TABLE OF CONTENTS
(Continued)

CHAPTER		PAGE
VIII.	INFLUENCE MAPS	220
	A. Non-Biomedical Maps	220
	1. Biology	220
	2. Chemistry	227
	3. Earth & Space Science	234
	4. Mathematics	237
	5. Psychology	237
	6. Engineering and Technology	237
	B. Influence Maps for Biomedicine	250
	1. Field Weighting and the Biomedical Structure Map	250
	2. Influence Maps for Individual Biomedical Fields	251
IX.	RELIABILITY	283
	A. Introduction	283
	B. Comparisons of Sets of Papers from Two Journals	284
	1. Statistical Parameters	284
	C. Comparison of the Publications of Institutions	298
	D. Citations to Institutions	299
X.	APPLICATION TO UNIVERSITY RANKING	308
	A. Introduction	308
	B. Publication Data Base	308
	C. Correlations between Publication Counts and Roose-Andersen Rankings	312
	D. Further Correlation Analysis	314

TABLE OF CONTENTS
(Continued)

	PAGE
REFERENCES	320
A. Bibliography	320
B. Computer Horizons Reports and Articles Generated Under National Science Foundation Contract C627	330
C. Related Reports and Article: National Institutes of Health Contract NO1-OD-3-2109	332
GLOSSARY	333
APPENDIX I - JOURNAL LISTS, BY FIELD AND SUBFIELD, WITH INFLUENCE MEASURES	A-1
A-I. Data Sources	A-1
A-II. Computational Considerations	A-2
A-III. Influence Measures for the Major Fields	A-5
A-IV. Influence Measures for the Subfields	A-7
A-V. Influence Measures for Journals	A-13
A-VI. Journal Coverage	A-15
APPENDIX II - ISI JOURNAL ABBREVIATIONS AND FULL TITLES	B-1

LIST OF FIGURES

FIGURE		PAGE
2-1	Important Papers on the Size of the Scientific Literature	9
2-2	Comparative Anatomy Publication Between 1540 and 1860	11
2-3	Number of Abstracts Published Each Year in <u>Physics Abstracts</u>	14
2-4	Bradford Plot of Health Services Articles Distribution	18
2-5	Number of Journals Founded as a Function of Date	22
2-6	Current Composition of the World's Technical Journal Literature	25
2-7	National Scientific Size vs. National Economic Size	31
3-1	Important Papers on the Structure of the Scientific Literature	41
3-2	Three Dimensional Representation of Intercorrelations of Psychology Journals	47
3-3	Bibliographic Coupling and Co- Citation Strength	54
3-4	Co-Citation Network for Frequently Cited Papers in Particle Physics	56
3-5	Two-Step Model for 62 Chemistry Journals in 1969	57
3-6	Hierarchy for 62 Chemistry Journals in 1969	58
3-7	Two-Step Cross-Field Model - 1969	60
3-8	Hierarchical Clustering of the Configuration of Business and Economics Journals	64

LIST OF FIGURES
(Continued)

FIGURE		PAGE
4-1	Important Papers on Scientific Productivity	66
4-2	Publication Frequency for Authors	68
4-3	Age Versus Contributions to Chemistry	69
4-4	Comparative Distribution of Logarithm of "Weighted" Rate of Publication	71
4-5	Correlation of Number of Citations with Number of Publications	75
4-6	Percentages of Papers Cited Various Numbers of Times	77
5-1	Publication Indices from Cartter Report (1966)	94
5-2	Correlations in Sociology	105
6-1	Stages of Publication and Citation Analysis	123
6-2	Lorenz Curve	133
6-3	Lorenz Curve for NIH Funding to 226 Recipient Institutions in 1972	135
6-4	Sample of Grouped Corporate Lists	139
6-5	Publication Output vs. NIH Funds for 133 Universities	142
6-6	Two-Step Referencing Map of the Alcoholism Research Literature	148
6-7	Part of Harvard University Listings in 1973 <u>Corporate Index</u>	155
6-8	<u>SCI Source Index</u> Structure	157

LIST OF FIGURES
(Continued)

FIGURE		PAGE
6-9	<u>SCI Citation Index</u> Structure	158
6-10	Reference Time Distribution for 1973	177
6-11	Concentration of Publications in Journals for Major Fields	182
7-1	Influence Map for Acoustics Journals	213
7-2	Influence Map for Optics Journals	214
7-3	Influence Map for Fluids & Plasma Journals	215
7-4	Influence Map for General, Solid State and Nuclear Physics Journals	217
7-5	Influence Map for Chemical and Applied Physics Journals	218
8-1	Influence Map for Zoology Journals	221
8-2	Influence Map for Entomology Journals	222
8-3	Influence Map for Botany Journals	223
8-4	Influence Map for Food and Agriculture and Dairy and Animal Science Journals	224
8-5	Influence Map for Ecology Journals	225
8-6	Influence Map for Marine Biology and Oceanography Journals	226
8-7	Influence Map for General Chemistry Journals	228
8-8	Influence Map for Organic Chemistry Journals	229
8-9	Influence Map for Inorganic and Nuclear Chemistry Journals	230

LIST OF FIGURES
(Continued)

FIGURE		PAGE
8-10	Influence Map for Analytical Chemistry Journals	231
8-11	Influence Map for Physical Chemistry Journals	232
8-12	Influence Map for Applied and Polymer Chemistry Journals	233
8-13	Influence Map for Astronomy and Astrophysics Journals	235
8-14	Influence Map for Geoscience Journals	236
8-15	Influence Map for General, Applied and Miscellaneous Mathematics Journals	238
8-16	Influence Map for Probability and Statistics Journals	239
8-17	Influence Map for Psychology Journals	240
8-18	Influence Map for Electrical Engineering and Computer Science Journals	241
8-19	Influence Map for Mechanical Engineering and Aerospace Technology Journals	242
8-20	Influence Map for Civil Engineering Journals	244
8-21	Influence Map for Nuclear Technology Journals	245
8-22	Influence Map for Chemical Engineering Journals	246
8-23	Influence Map for Metals and Metallurgy Journals	247
8-24	Influence Map for Materials Science Journals	248
8-25	Influence Map for Operations Research, Library and Information Science Journals	249

LIST OF FIGURES
(Continued)

FIGURE		PAGE
8-26	Influence Structure for the Biomedical Literature	252
8-27	Influence Map for Allergy and Immunology Journals	254
8-28	Influence Map for Anesthesiology Journals	255
8-29	Influence Map for Arthritis/ Rheumatism Journals	256
8-30	Influence Map for Cancer Journals	257
8-31	Influence Map for Cardiovascular System Journals	258
8-32	Influence Map for Dentistry Journals	259
8-33	Influence Map for Dermatology/ Venereal Diseases Journals	260
8-34	Influence Map for Endocrinology Journals	261
8-35	Influence Map for Genetics Journals	262
8-36	Influence Map for Geriatrics/ Gerontology Journals	263
8-37	Influence Map for Hematology Journals	264
8-38	Influence Map for Obstetrics/ Gynecology and Fertility Journals	265
8-39	Influence Map for Otorhinolaryngology and Ophthalmology Journals	266
8-40	Influence Map for Pathology Journals	267
8-41	Influence Map for Pediatrics Journals	268
8-42	Influence Map for Radiology and Nuclear Medicine Journals	269

LIST OF FIGURES
(Continued)

FIGURE		PAGE
8-43	Influence Map for Respiratory System Journals	270
8-44	Influence Map for Veterinary Journals	271
8-45	Influence Map for Biochemistry/Molecular Biology/Biophysics/Physiology Journals	272
8-46	Influence Map for Cell Biology/Anatomy/Embryology/Microscopy Journals	273
8-47	Influence Map for Environmental and Public Health/Tropical Medicine and Parasitology Journals	274
8-48	Influence Map for Gastroenterology Journals	275
8-49	Influence Map for General and Internal Medicine/Clinical Science Journals	276
8-50	Influence Map for Neurological System Journals	277
8-51	Influence Map for Nutrition and Dietetics Journals	278
8-52	Influence Map for Orthopedics/Surgery/Urology Journals	279
8-53	Influence Map for Pharmacology and Pharmacy Journals	280
8-54	Influence Map for Psychiatry Journals	281
8-55	Influence Map for Virology and Microbiology Journals	282
9-1	Distribution of 8083 Citations from 1973 Papers to 3247 Papers Published in <u>Phys Key</u> in 1970	286
9-2	Mean Influence/Publication	288

LIST OF FIGURES
(Continued)

FIGURE		PAGE
9-3	Distribution of Citations to Papers Cited N Times	290
9-4	1973 to 1970 Influence vs. Lifetime Influence	291
9-5	90% Confidence Curves for Determining Sample Size	295
9-6	Confidence Levels for a Fixed Influence/ Publication = 20.0	297
9-7	Citations from 1973 to the 1970 Publications of Groups of Universities	304
10-1	Spearman Rank Correlation for Publication and Influence Weighted Publication Rank vs. Roose-Andersen Rank	315

LIST OF TABLES

TAELE		PAGE
2-1	Journal by Country Counts, 1901-1913	12
2-2	National Share of Journal Abstracts in <u>Chemical Abstracts</u>	15
2-3	Total Number of Current Scientific and Technical Serials Published as of 1961	27
2-4	NLL Serials on Order, December 1965	29
2-5	Comparison of Publication and Abstract Counts for 1972	34
2-6	Citation to Publication Measure for Citation to the U.S.	36
2-7	Citation to Publication Measure Within Each Country	37
2-8	Citation to Publication Measure from Outside Each Country	38
3-1	Pairs of Papers Most Strongly Coupled	49
3-2	Six Large Journals with Impact Factors Greater than Five	52
3-3	Twenty Journals with Highest Impact Factors	53
3-4	Clusters for a Set of 81 Physics Journals	62
4-1	A Classification of References in 30 Articles in <u>Physical Review</u> , Published on Theoretical High Energy Physics from 1968 to 1972, Inclusive	80
5-1	Papers Comparing Bibliometric and Non-Bibliometric Measures	85

LIST OF TABLES
(Continued)

TABLE		PAGE
5-2	Predictors of Academic Rank	90
5-3	Department Quality by Citation Count: 1957-1958 Biochemistry Doctorates	92
5-4	Comparison of Peer and Citation Ranking of Economics Journals	93
5-5	Intercorrelations of Indices of Eminence	96
5-6	Scientific Output and Recognition	97
5-7	Correlations between the Cartter Ratings and Publication Counts for 20 Journals	99
5-8	Correlations between the Roose- Andersen Ratings and Publication Counts for 20 Journals	100
5-9	Distribution of 125 Sampled Depart- ments by Rated Quality of Graduate Faculty (Sample Size Greater than Five)	102
5-10	Factor Analysis of Department Quality Indicators	103
5-11	Product-Moment Correlations Among Selected Characteristics of 125 Departments in Biology, Mathematics, Physics and Chemistry (Sample Size Greater than Five)	104
5-12	Publication Frequency for ARS Scientists	108
5-13	Correlation between Merit and Publication Indices for ARS Scientists	109

LIST OF TABLES
(Continued)

TABLE		PAGE
5-14	Publication Weights for Sociology	111
5-15	Quality of Scientific Articles vs. Rate of Citation	113
5-16	Alternative Methods of Rating <u>JATP</u> Papers for 1967-1968	115
5-17	Association between Judge Ratings, Citation Frequency, and Agreement between Judges	119
6-1	Agency Support Acknowledgements in 20 Leading Journals from 5 Major Fields - 1969 and 1972	128
6-2	Changes in NIH Funding Concentration	134
6-3	Total Biomedical Research Funding by Federal and Private Agencies to 229 Institutions	137
6-4	<u>Science Citation Index</u> 1961-1974 Comparative Statistical Summary	145
6-5	<u>Social Science Citation Index</u> 1972-1974 Comparative Statistical Summary	146
6-6	Major Field Coverage by SCI in 1973	149
6-7	Country Breakdown of 1972 Publications on 1973 <u>SCT Corporate Tape</u>	151
6-8	Characteristics of Major Abstracting and Indexing Services	165
6-9	Publication Type Tabulation from 1973 <u>Corporate Index</u>	170
6-10	Field and Subfield Publication and Reference Counts	171

LIST OF TABLES
(Continued)

TABLE		PAGE
6-11	Reference Time Distributions for Major Fields	176
6-12	Immediacy of Referencing for Major Fields	178
6-13	Fifty Largest, and Fifty Most Influential, Physics Journals	179
7-1	List of Subfields	191
7-2	Cross Citing Between 3 Key Journals	194
7-3	Referencing Rank Order Among Prototype Journals in 1973	200
7-4	Referencing from Prototype Journals in 1973	201
7-5	Cross Citing Between 3 Multidisciplinary Journals	204
7-6	Influence Measures for 3 Multidisciplinary Journals	205
7-7	Influence Measures for Physics Journals	207
9-1	Influence Measures for 16 Selected Journals	285
9-2	Variance Data for 16 Journals	289
9-3	χ^2 Test Showing 1973 to 1970 Influence Measures to be 1:10 of Total Lifetime Influence Measures	292
9-3	Aggregation of Physics Departments	302
9-5	1973 Citations to 1970 <u>Physical Review</u> Publication for Groups of Universities	303
9-6	Group Pairs with Significantly Different Citation/Publication Means-- <u>Physical Review</u>	305

LIST OF TABLES
(Continued)

TABLE		PAGE
9-7	1973 Citations to the 1970 <u>Journal of the American Chemical Society</u> of Groups of Universities	306
9-8	University Group Pairs with Significantly Different Citation/Publication Means-- <u>Journal of the American Chemical Society</u>	307
10-1	Publication Data Base	310
10-2	Spearman Rank Correlations Between Publication Rankings and Rose-Andersen Rankings	313
10-3	Cross Field Correlations for Rose-Andersen Score	317
10-4	Cross Field Correlations for Total Number of Publications	318
10-5	Cross Field Correlation for Influence per Publication	319

APPENDIX I

LIST OF TABLES

TABLE		PAGE
A-1	Influence Measures for the Major Fields	A-6
A-2	Influence Measures for the Subfields	A-8
A-3	Journal Assignments & Influence Measures (1973 Data)	A-16

I. INTRODUCTION

A. An Overview of Publication and Citation Analysis

Publication and citation counting techniques have been used in the assessment of scientific activity for at least fifty years. During the half-century of this activity the main thrust of interest seems to flow along two connected but parallel paths: the bibliometric path of publication and citation counts as tools for the librarian, and an evaluative path using these same tools to illuminate the mosaic of scientific activity.

For decades librarians have used citation counts to study the adequacy of a collection of periodicals. For decades economists and historians of science have looked upon publication and citation counts as indicators of productivity and eminence. The term "evaluative bibliometrics" will be used in this monograph to denote the use of bibliometric techniques, especially publication and citation analysis, in the assessment of scientific activity.

Evaluative bibliometrics has displayed an almost classic developmental pattern, if one considers the bibliometric aspect to be basic research and the evaluative aspects to be applied research. Bibliometric techniques were initially developed to aid the librarian. Gross and Gross'¹ 1927 paper first suggested the use of citation counts in measuring the adequacy of a college library. Over the ensuing decades dozens of papers appeared applying this bibliometric technique to other scientific literatures. Intertwined with these dozens of bibliometric papers are observations about the national characteristics of the cited literatures, which anticipate today's evaluative uses of citations.

Appropriately, one of the earliest bibliometric papers, that of Cole and Eales,² was clearly evaluative in nature. Cole and Eales' 1917 paper described and interpreted a count of the literature of comparative anatomy from the years 1543 through 1860. While their data were bibliometric, their motive was clearly evaluative: they were interested in measuring the relative contributions and performance of the participating countries over three centuries.

It is, however, the advent of "big science" that has flushed these studies from the quiet obscurity of the librarian and historian to the battlements of science policy; the potential for

¹P.L.K. Gross and E.M. Gross, "College Libraries and Chemical Education," Science 66 (October 28, 1927):1229-1234.

²F.J. Cole and Nellie B. Eales, "The History of Comparative Anatomy," Science Progress 11 (1917):578-596.

use, and the potential for abuse of these techniques have motivated this monograph. By placing these techniques within their historical context perhaps some of the more emotional hostility to this application of quantitative techniques will be stilled. Further, the monograph shows that these techniques yield results which are entirely consonant with the intuitive perceptions of the leaders of science. Most bibliometric evaluations of papers, people, or institutions correlate well with peer evaluations.

Evaluative bibliometrics shows that there are large differences in influence among scientific journals; few scientists would deny this. Evaluative bibliometrics shows that our great scientific institutions are in fact publishing large numbers of highly cited papers in highly influential journals; few scientists would dispute this. Evaluative bibliometrics shows that scientific activity is related to Gross National Product (GNP), and that, as the economic might of the United States and the Soviet Union have grown over the last 50 years, so have their measured positions in the scientific world; few would question this. Clear evidence emerges that the productivity of individuals varies widely, and that the truly creative scientists publish often, are heavily cited, and contribute to the progress of science in an amount which is many times that of the average scientist. Few would object to this observation.

The fact that these techniques yield acceptable assessments of scientific activity is of substantial importance, since their use at a policy level seems inevitable. A dozen years ago Weinberg succinctly anticipated the problems that the growth of "big science" would provide for the policy analyst. He states that

...as science grows, its demand on our society's resources grow. It seems inevitable that science's demand will eventually be limited by what society can allocate to it. We shall have to make choices. These choices are of two kinds. We shall have to choose among different often incommensurable fields of science - between, for example, high energy physics and oceanography or between molecular biology and science of metals. We shall also have to choose among the different institutions that receive support for science from the government - among universities, governmental laboratories and industry. The first choice I call scientific choice: the second, institutional choice. My purpose is to suggest criteria for making scientific choices - to formulate a scale of values which might help establish priorities among scientific fields whose only common characteristics is that they all derive support from the government"³

³ Alvin M. Weinberg, "Criteria for Scientific Choice," Minerva 1 (Winter, 1963):159.

The strength of publication and citation analysis lies in its flexibility to meet the small scale demands of the earlier historian, as well as in its ability to encompass the much larger scale needs of the science analyst today. This ability of publication and citation analysis to encompass different levels of aggregation makes it a technique ideally suited to national and institutional studies. At each level the data gained provides a background for increasingly sophisticated statistical techniques with which to extract the information within the data.

The broad application of citation analysis is clearly attributable to the appearance of the Science Citation Index (SCI), compiled by the Institute for Scientific Information from some 5 million yearly references* contained in 400,000 articles in 2,300 central scientific journals.⁴

Originally, the SCI was a tool for information retrieval on a grand scale. Every year since its inception in 1961 the Index has expanded to include a larger set of journal literature throughout the world. There have been deletions as well as additions, but the SCI has improved and gained in accuracy with every change.

As a labor saving device the mechanical advantages of the SCI have been accompanied by some inherent problems and complications. These problems fall into two categories.

The first of these two problem categories can be defined as "noise", i.e., the random spelling errors, incorrect pagination, incorrect attributions, and the incredible variety of journal abbreviations which the world's scientists use in referring to the work of others.

The second category consists of the systematic errors which are imposed on the data by the method of compiling the SCI. These errors have the greatest impact on results obtained using the SCI data base. The major system problems include:

- (1) The first author problem, which arises directly out of the SCI convention of listing only the first author of multi-

*Throughout this monograph the following convention will be followed: a citation is defined as the acknowledgment one unit receives from another: a reference is defined as the acknowledgment one unit gives to another. Units are chosen according to the level of aggregation, e.g., articles or journals. For example, the first acknowledgment in this monograph of the paper of Gross and Gross would be considered a reference from this monograph, as well as a citation to the paper of Gross and Gross.

⁴Institute for Scientific Information, Science Citation Index.[®] Philadelphia, PA. 19106

authored articles in its Citation Index. This problem enormously complicates the fair attribution of credit for citations to the authors of multi-authored articles.

- (2) The selectivity problem, which arises because ISI must choose a limited set of significant journals from the approximately 25,000 world scientific serials. While the 2,300 journals covered by SCI seem to be remarkably representative of the central core of the physical and biological sciences and of the published literature in most major scientific countries, there are distinct limitations when one attempts to use the SCI as representative of the more peripheral scientific areas and more specialized literatures of the smaller countries.

These shortcomings do not diminish in any way the value of the SCI; the SCI provides a cautious researcher with an unequalled amount of material for scrutinizing the sciences. General estimates of behavior patterns in the scientific literature can now be made: the average paper has approximately 15 references; 50% of all the references in the SCI are to the papers in only 152 journals; in any given year about one-third of the existing papers are not cited at all; scientific papers are cited once a year, on the average; the threshold for defining important papers appears to be a citation rate of 3 or 4 times a year, a number which only a few percent of all papers ever achieve.^{5,6}

While the Science Citation Index is multi-disciplinary and compact, the literature of publication and citation analysis is field-specific and widely dispersed. The result has been that early work was sometimes duplicated, and current work is sometimes duplicated in different fields. With the exception of the work of Derek J. de Solla Price, there have been few real syntheses in the field. A number of papers have summarized and reviewed prior papers; yet it is Price's books and papers, his ideas and his assertions, sometimes imprecise but always evocative, which have stirred the field from somnolence.⁷

⁵Eugene Garfield, "Citation Analysis As a Tool in Journal Evaluation," Science 178 (November 3, 1972):472-479.

⁶Derek J. de Solla Price, "Networks of Scientific Papers," Science 149 (July 30, 1965):510-515.

⁷see especially: Derek J. de Solla Price, Science Since Babylon, enlarged edition, (New Haven: Yale University Press, 1975).

Derek J. de Solla Price, Little Science, Big Science, (New Haven: Yale University Press, 1963).

Progress has not been smooth. The scientific establishment has been cautious and sometimes openly hostile to publication and citation analysis. Scientists have questioned the validity of using publication and citation data, especially when applied to the individual since real dangers can arise out of this incautious application of publication and citation analysis.

Apart from the procedural problems, the fundamental issue of scientific "property rights" may be threatened by the advent of publication and citation analysis. The property rights of science become simply one thing:

...the recognition by others of the scientist's distinctive part in having brought the result into being.⁸

Recognition of originality of one's peers is

...validated testimony that one has lived up to the most exacting requirements of one's role as scientist.⁹

Publication and citation analysis is viewed by some as unwarranted meddling with the institutional norms of science: property rights and recognition.

B. Structure of the Monograph

This monograph is structured to provide the reader with insight into three major aspects of evaluative bibliometrics. First, the historical development is covered in Chapters II through IV. Second, the correlation of bibliometric and non-bibliometric measures, and some operational limitations are covered in Chapters V and VI. Third, the influence methodology and closely related current applications are covered in Chapters VII through X.

Chapter II deals with the size of the scientific enterprise, as measured during the fifty year history of publication counts. Many of these are both evaluative and bibliometric. The counts enumerate the size of the scientific literature; the motivation for the counts, more often than not, was an interest in national scientific performance.

Chapter III discusses studies which have outlined the structure of the scientific literature. These studies are, in general, field-specific, with a notable lack of communication between the early workers in different fields, and a recurrence of interest in measuring the relationship of one scientific journal to another. The studies of the structure of the scientific literature discussed in Chapter III provide the basis for the field

⁸Robert K. Merton, "Properties in Scientific Discovery" in The Sociology of Science, ed. Norman W. Storer (Chicago: University of Chicago Press, 1973) p. 295.

⁹Ibid., p. 293.

classification of scientific journals. Such a classification is a prerequisite for any detailed analysis of scientific activity. Chapter III, and the more sophisticated work reported in Chapters VII and VIII, show that the journal literature provides well-defined boundaries between most scientific fields and subfields, with the notable exception of a few percent of the scientific journals which fill multi-disciplinary roles.

In Chapter IV the early studies of scientific productivity are reviewed. The consistent conclusion from the studies in this chapter is that scientific talent is highly concentrated in a limited number of individuals; this conclusion certainly indicates that science policy should be designed to encourage our more productive scientists. Yet there seem to be surprisingly few modern studies of scientific productivity. Indeed, some of Shockley's speculations concerning the great disparities in scientific productivity between different individuals and different laboratories seem never to have been pursued.¹⁰

In Chapter V a few dozen comparative studies are reviewed. These studies all tend to show that literature-based measures of the quality or quantity of scientific output correlate positively with non-literature measures. Peer evaluations of the eminence of scientists and of scientific institutions are almost always correlated with both citation and publication measures. For institutions, the great disparities in the size seem to cause the quantity of publications to dominate the comparison. For individuals, the comparisons may be more highly correlated with citations than with publications. In either case, the correlations often seem to lie in the 0.6 to 0.8 range. When relatively large aggregates of publications are considered, such as the publications of major universities, correlations between peer rankings and publication measure are sometimes as high as 0.9.

Chapter VI discusses some operational considerations necessary to perform this kind of analysis. General discussion and specific data are presented to illustrate the areas of applicability of the Science Citation Index and of other reference services. The main problems in dealing with the SCI are discussed, including the first author problem, and the variation of bibliometric parameters across the major fields of science.

Chapters VII, VIII and IX cover the influence methodology: a procedure for the calculation of individual journal influence. Sets of self-consistent, normalized influence weights have been calculated for each journal, based on an analysis of the journal's citation relationship with interacting journals. The influence

¹⁰William Shockley, "On the Statistics of Individual Variations of Productivity in Research Laboratories," Proceedings of the IRE, (March, 1957):279-290.

weights are generated by applying matrix methodology to the citation matrix for each journal group, where the citation matrix is the square array of citations received by each journal from itself and every other journal.

The influence methodology is a useful approximation when dealing with large aggregates of publications, (those of university departments and larger groups) since it avoids many of the tedious, time consuming, and error prone steps in inferring institutional and programmatic performance parameters from citation records of individual scientists.

Chapter X briefly compares a ranking of universities based on bibliometric measures with the Roose-Andersen study.¹¹ The comparison encompasses 11 fields, and 132,000 publications, and illustrates the potential of the influence methodology for separating the effects of size and influence in a bibliometric analysis.

Chapter XI contains references from the first ten chapters, as well as a list of the reports and papers which have been written in the course of this contract.

Following Chapter XI is a brief glossary of technical terms used in the monograph.

Finally, the Appendix contains classification and influence data for nine major scientific fields, 100 subfields and approximately 2,300 journals. These measures are based on the more than 5,000,000 citations in the 1973 SCI. Each SCI journal has been classified into a field and a subfield, and the biomedical journals have also been given a research level (clinical to basic) classification. As the only coordinated system for both classifying and weighting these 2,300 scientific journals, this data should become a source document for many future studies.

¹¹Kenneth D. Roose and Charles J. Andersen, A Rating of Graduate Programs, (Washington, D.C.: American Council on Education, 1970).

II. SIZE OF THE SCIENTIFIC ENTERPRISE

The idea of using a count of scientific publications to measure the dimensions of the scientific enterprise is at least 60 years old. Some of the papers discussed below are bibliometric, with their origins in the realm of the librarian. However, the majority have a strong evaluative flavor, with their origins in an innate curiosity about the functioning of international science.

Figure 2-1 shows some of the key papers dealing with the size of the scientific literature. The first paper appears to be the 1917 paper by Cole and Eales, who counted the number of publications which had appeared on the subject of comparative anatomy from the year 1543 to the year 1860.¹ Their study had a clearly defined objective: to determine which groups of animals and which aspects of anatomy engaged the attention of workers and to trace the influence of contemporary events on the history of anatomical thought. Cole and Eales also attempted to detach and plot separately the performance of each European country. They summed these goals by stating that:

...it seemed possible to reduce to geometrical form the activities of the corporate body of anatomical research, and the relative importance from time to time of each country and division of the subject.²

Cole and Eales were acutely aware of some of the limitations of their bibliometric techniques. They remarked that:

A chart represents numerical values only, and may by itself be seriously misleading. The author of 50 small ephemeral papers is, judged by figures of greater importance than William Harvey, represented only by two entries, both of great significance. It is hence necessary that any conclusions drawn from the charts should be checked by an examination of the scientific value of the literature dealt with.³

A point to be made a number of times in this monograph, and quantitatively commented upon in Chapters VI and IX, is that many bibliometric techniques are of questionable reliability when applied to small numbers of publications. Cole and Eales seem to have recognized that limitation in 1917.

¹F.J. Cole and Nellie B. Eales, "The History of Comparative Anatomy," Science Progress, 11 (1917):578-596.

²Ibid., p. 578.

³Ibid., p. 578.

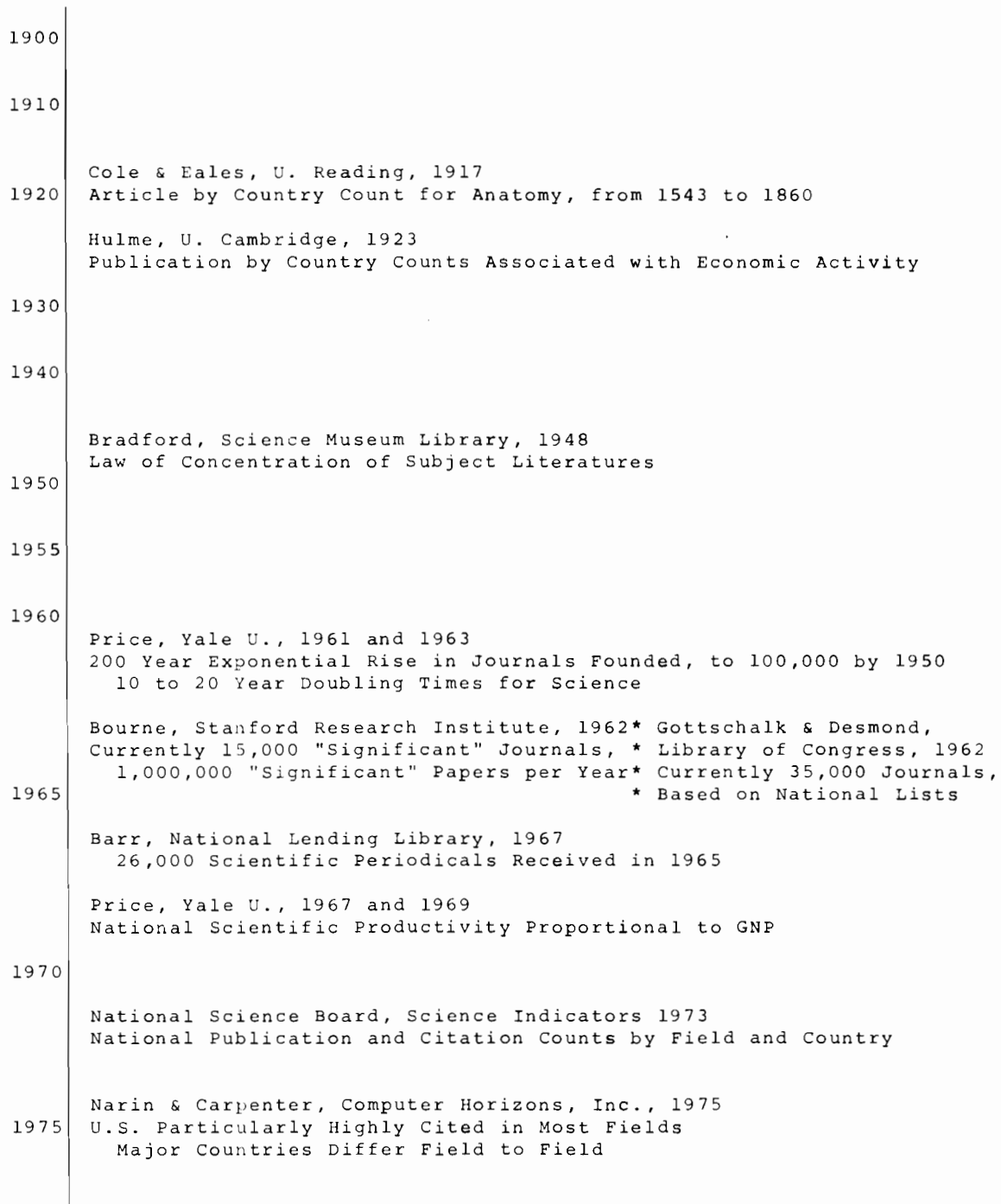

FIGURE 2-1

IMPORTANT PAPERS ON THE SIZE OF THE SCIENTIFIC LITERATURE

They also recognized many of the minor difficulties and inconsistencies involved in bibliometric studies, including such points as "how are we to compose the claims of parentage, birth-place and domicile?", and noted that

In the matter of dates it is often important to record the year or years when the work was actually accomplished, rather than the date of publication, which may be years subsequent to the death of the author.⁴

They also pointed out some of the approximations involved in assigning a publication to a particular geographic place, pointing out that "Harvey, for example, published his treatise on the Circulation at Frankfurt, because he considered its prospects of becoming known were greater than London publication could secure".⁵

After discussing these limitations Cole and Eales proceeded to analyze the records of 6,436 publications which deal entirely or in part with the anatomy of animals, published between the years 1543 and 1860. Figure 2-2 is a redrawn version of their chart; even a brief scan of the chart shows the sporadic beginnings of the field. Not until 1650 did a steady stream of publications begin to rise, reaching a peak in 1682, followed by a decline to a relatively level rate which begins to rise steadily again after the middle of the 18th century. Cole and Eales made a basic observation about the necessity of the scientific journal, and the constraints existent before the first journal appeared (in 1665, as Philosophical Transactions of the Royal Society, and as the Journal des Scavans):

So far the old method of publications by book and pamphlet had survived in spite of vital and manifest drawbacks. It meant that unless an author had much to say, he had little opportunity of saying it. It suppressed the short and important paper, but offered no bar to verbose incapacity. It worked slowly, and imposed a financial burden on author and public. In the matter of publicity, it left too much to the book-seller, and there was no organized attempt to exchange and circulate scientific literature. The remedy for all this was the periodical publication, in which short communications were encouraged, which abbreviated the delays and expense incidental to books,

⁴Ibid., p. 579.

⁵Ibid., p. 579.

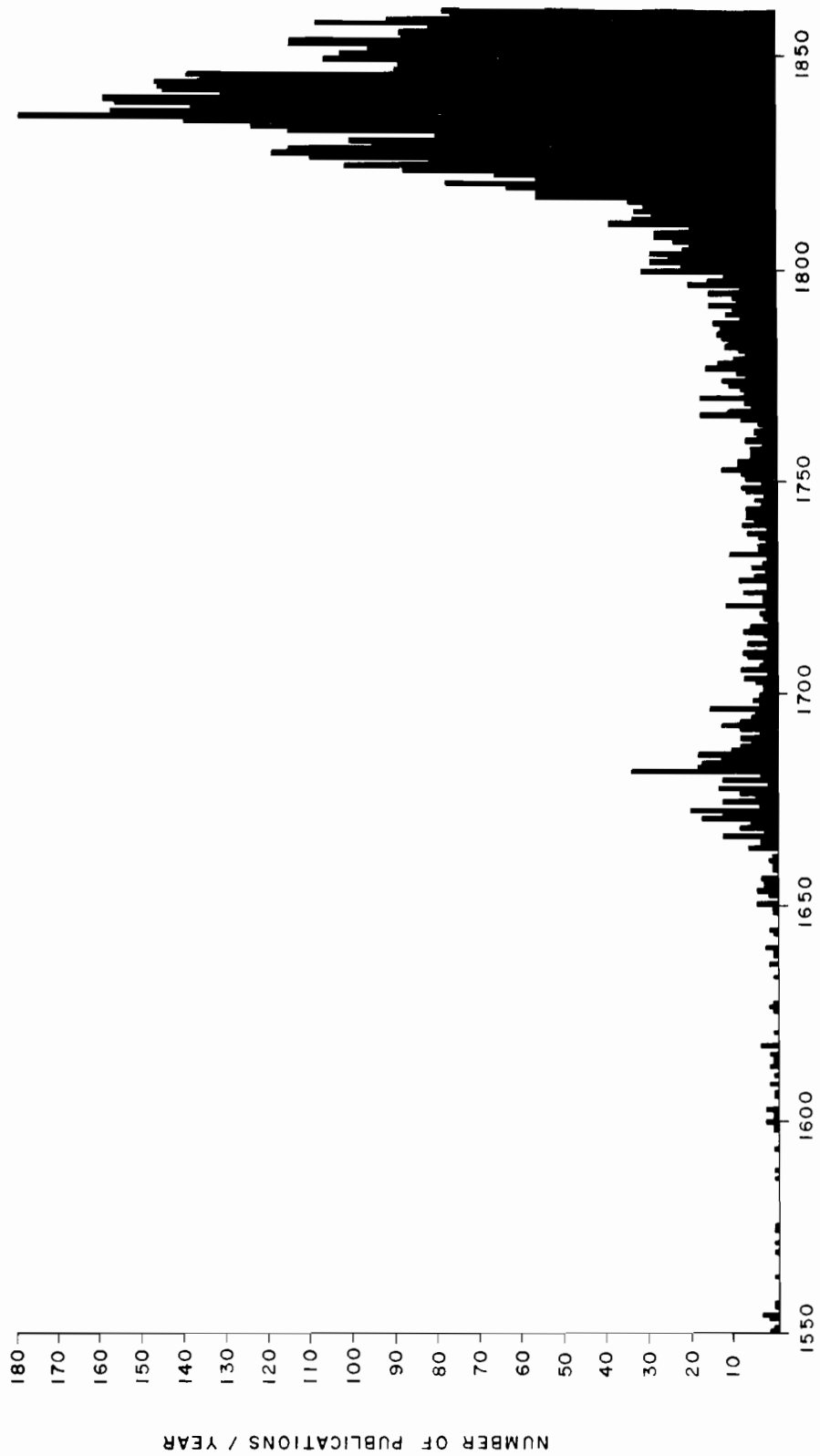

FIGURE 2-2
 COMPARATIVE ANATOMY PUBLICATION BETWEEN 1540 and 1860
 (adapted from Cole & Eales, 1917)

and by the cooperation and fellowship of interested opinion ensured a wide speedy circulation. It may, in fact, be claimed that science could not have made the advance that it has but for the recognition of the periodical as the most convenient and efficient method of encouraging research.⁶

The next publication shown on Figure 2-1 is the 1923 book by Hulme.⁷ In this book Hulme analyzed both author and journal entries in the International Catalog of Scientific Literature for the period 1901 through 1913. The total number of journals indexed, 8,288, was tabulated and rank-ordered by country in the following way:

TABLE 2-1
JOURNAL BY COUNTRY COUNTS, 1901-1913
(adapted from Hulme, 1923)

Rank	Country	% of Total Journals
1	Germany	28.4%
2	France	12.1%
3	Russia	9.5%
4	United States	7.9%
5	United Kingdom	7.7%
6	Austria	7.3%
7	Italy	7.3%
8	Belgium	3.5%
9	Switzerland	2.2%
10	Holland	1.8%
11	Japan	1.6%
	All Others Combined	10.7%
Total Number Journals		8,288

⁶Ibid., p. 588.

⁷E.W. Hulme, Statistical Bibliography in Relation to the Growth of Modern Civilization, (London: Grafton, 1923).

Hulme also discussed and plotted the total output of author entries for each year. The resultant curve shows a slightly erratic growth from perhaps 43,000 author entries in 1901 to about 85,000 entries in 1910, followed by a rather sharp decline to 63,000 entries in 1913. Hulme attributed this decline to factors associated with a corresponding flattening of curves of population in England and Western Europe and the general decline in economic expansion that occurred at that time.

Other general censuses of the numbers of scientific journals or papers would seem likely following the early work of Cole and Eales and that of Hulme. However, a reasonably thorough literature search did not uncover any general census of the scientific literature until the 1960's although some censuses had been made in the various specific subject literatures. For example, in 1953 Daniel and Louttit, whose work in psychology is discussed more extensively in the next chapter, published an analysis of the number of psychological journals, and their languages, from 1850 through 1950.⁸ They showed that the number of titles in the psychological literature increased from a few thousand in 1900 to 7,000-8,000 by 1950.

A detailed paper by Orr and Leeds in 1964 estimated that the world's "substantive" biomedical journals numbered about 5,700 in 1960.⁹ They also estimated that 16,000 documents were generated in 1961-1962 by grantees of NIH, of which 90% were journal publications.

An extensive longitudinal study of the size of the physics literature was published by L.J. Anthony and others in 1969.¹⁰ The growth of physics, as measured by the entries in Physics Abstracts is shown in Figure 2-3.

A less detailed census of chemistry papers was published in 1971 by D.B. Baker.¹¹ Unfortunately, Baker's article is based on all of Chemical Abstracts, which overlaps into neighboring fields of biology, physics, and engineering. Table 2-2 summarizes Baker's data. While the data base of some 300,000 papers,

⁸Robert S. Daniel and C.M. Louttit, Professional Problems in Psychology, (New York: Prentice-Hall, 1953).

⁹Richard H. Orr and Alice A. Leeds, "Biomedical Literature Volume Growth and Other Characteristics," Federation Proceedings 23 (November-December, 1964):1310-1331.

¹⁰L.J. Anthony, H. East, and M.J. Slater, "The Growth of Literature in Physics," Reports on the Progress of Physics 32 (1969):709-767.

¹¹Dale B. Baker, "World's Chemical Literature Continues to Expand," Chemical and Engineering News 49 (July 13, 1971): 37-40.

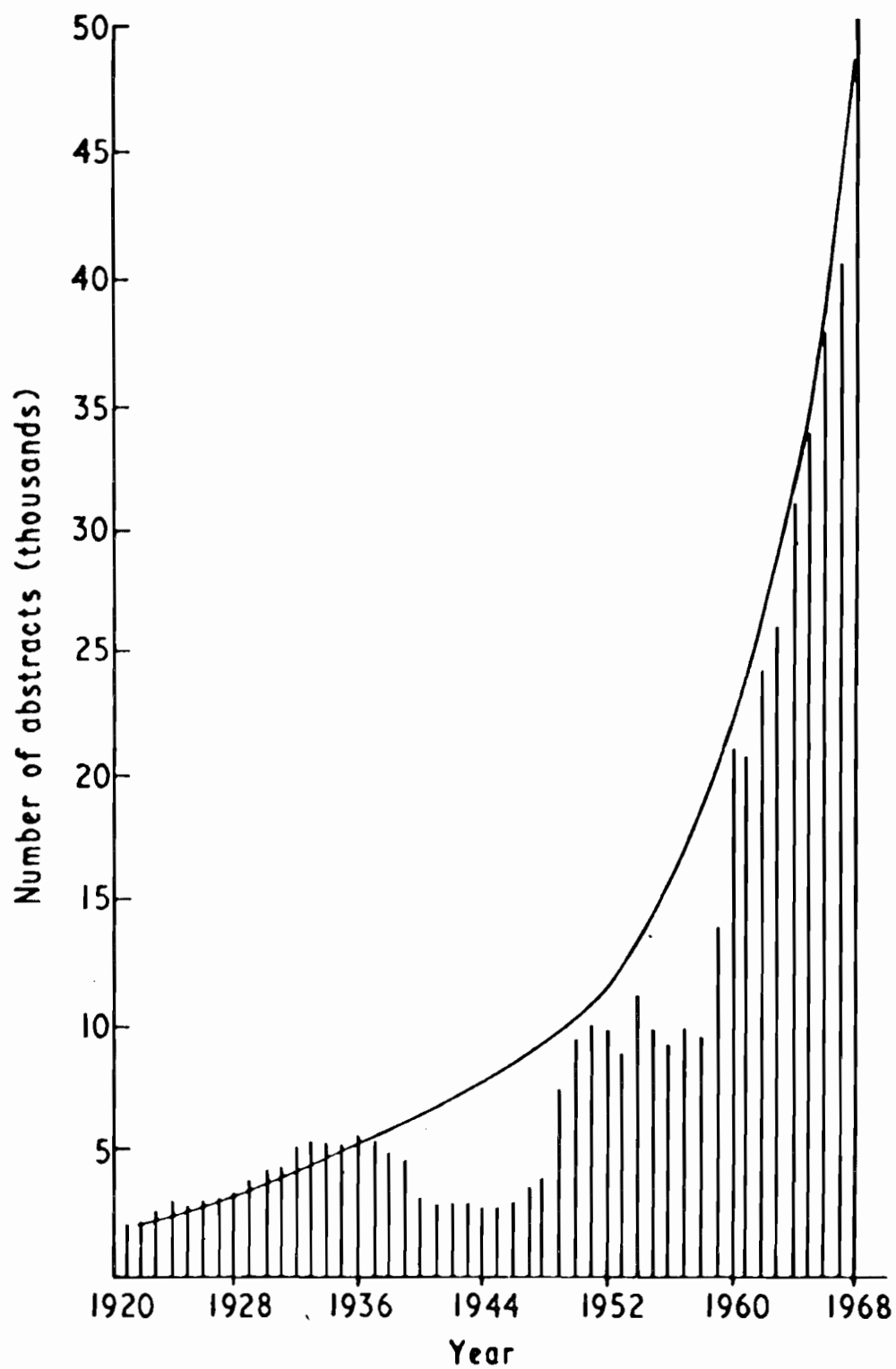

FIGURE 2-3

NUMBER OF ABSTRACTS PUBLISHED EACH YEAR IN PHYSICS ABSTRACTS
 (from Anthony, et al, 1969)

TABLE 2-2

NATIONAL SHARE OF JOURNAL ABSTRACTS IN CHEMICAL ABSTRACTS^a
 (from Baker, 1971)

	1951	1956	1960	1965	1970
U.S.	36.6%	28.4%	27.1%	28.5%	27.4%
U.S.S.R.	6.3	13.5	19.1	20.7	23.6
Japan	9.1	10.4	7.8	7.3	7.2
Germany, East and West	7.9	8.4	7.8	8.5 ^b	6.5 ^c
U.K.	9.6	7.5	7.7	6.7	6.2
France	6.2	6.0	5.0	4.5	4.1
Italy	3.3	4.1	3.2	2.7	2.7
India	na ^d	na ^d	2.2	2.2	2.7
Canada	na ^d	na ^d	1.9	2.0	2.4
Czechoslovakia	na ^d	1.6	2.0	1.6	2.0
Poland	na ^d	na ^d	na ^d	2.9	1.8
All others	21.0	20.1	16.2	12.4	13.4

a-Basis is on percentage of total journal abstracts by country.

b-West Germany, 6.3%; East Germany, 2.2%.

c-West Germany, 5.3%; East Germany, 1.2%.

d-Included in "All others."

na-Not available.

TOTAL PUBLICATIONS ABSTRACTED 145,000 (1962) 300,000 (1970)

patents, and reports is massive, major components of the data base would more properly be considered to lie in physics and biology. Some of the overlap of the different abstracting services has been discussed in 1971 and 1973 papers by J.L. Wood and others.^{12,13}

There are other studies of this kind, dealing with other specific subject literatures.

Returning to Figure 2-1, a landmark event in the field of bibliometrics was Bradford's 1948 publication of an empirical law of concentration for articles in the scientific periodical literature.¹⁴ Bradford's Law states that the articles on a given subject concentrate heavily in a relatively small core of highly productive journals. Although Bradford had first published his observation in 1934, it did not seem to have much impact until the 1950s. Bradford expressed his law in this manner:

...if scientific journals are arranged in order of decreasing productivity of articles on a given subject, they may be divided into a nucleus of periodicals more particularly devoted to the subject, and several groups or zones containing the same number of articles as the nucleus, when the numbers of periodicals in the nucleus and succeeding zones will be as 1: n: n²: ...¹⁵

This law provides a very convenient base for estimating the size of a subject literature, and a means of estimating how many journals must be checked to obtain a specified degree of completeness.

A general form of this law says that R(n), the cumulative number of papers on a given subject, will be related to the n journals in which they appear by

$$R(n) = R(1) + k \cdot \log_e (n) \quad (1)$$

¹²James L. Wood, Carolyn Flanagan, and H. Edward Kennedy, "Overlap Among the Journal Articles Selected for Coverage by BIOSIS, CAS, and EI," Journal of the American Society for Information Science (January-February 1973):25-28.

¹³James L. Wood, Carolyn Flanagan, and H. Edward Kennedy, "Overlap in the Lists of Journals Monitored by BIOSIS, CAS, and EI," Journal of the American Society for Information Science 24 (January-February 1972):36-38.

¹⁴S.C. Bradford, Documentation (London: Crosby, 1948).

¹⁵Tefko Saracevic, ed. Introduction to Information Science, (New York: R.R. Bowker Co., 1970) p. 144.

where k is a constant, and $R(1)$ is the number of papers in the journal with the most papers. When plotted on semi-log paper, this equation is a straight line. Differentiating Equation (1) leads to Equation (2), where $r(n)$ is the number of papers in the n th journal ($n > 1$)

$$\frac{dR(n)}{dn} = r(n) = k/n. \quad (2)$$

Figure 2-4 shows a Bradford curve for the health services articles contained in a 5 year bibliography of the health services research literature.¹⁶ Substituting into Equation (1) the values, from Figure 2-4, of 606 for $R(1)$ and 1975 for $R(10)$ yields a value for k in Equations (1) and (2) of 594. Thus, we have the following two equations for the health services articles distribution:

$$R(n) = 606 + 594 \times \log_e n \quad (3)$$

$$r(n) = 594/n \quad (4)$$

Since $r(n)$ is the number of papers in the n th journal, and the time scale of the bibliography is 5 years, $r(n) = 5$ approximately corresponds to the number of journals with one health services article per year; solving Equation (4) for n where $r(n) = 5$ yields a value of $n = 119$. That is, from the Bradford plot, one would estimate that 119 journals contained one or more health services articles per year, on the average, over the five years studied.

It should be noted that, at about $n = 30$, the empirical data in Figure 2-4 begins to droop away from a straight line. This droop is characteristic of Bradford plots and is called the Groos Droop. It can be interpreted either as a measure of incompleteness of the search, or as related to the finiteness of the population of journals and papers. Since the empirical curve droops below the straight line, the empirical data indicate that far fewer than 119 journals actually have one or more health services articles per year.

Following the work of Bradford, a veritable flood of papers have discussed the applicability of Bradford's Law to various bibliometric problems, from estimating the size of a collection on a specific subject such as vitamins, to structuring an optimum

¹⁶Francis Narin and Joan J. Sierecki, The Collection and Analysis of Health Services Research Journal Literature 1965 to 1969, Computer Horizons, Inc. for National Center for Health Services Research and Development under Contract number HSM 110-70-290.

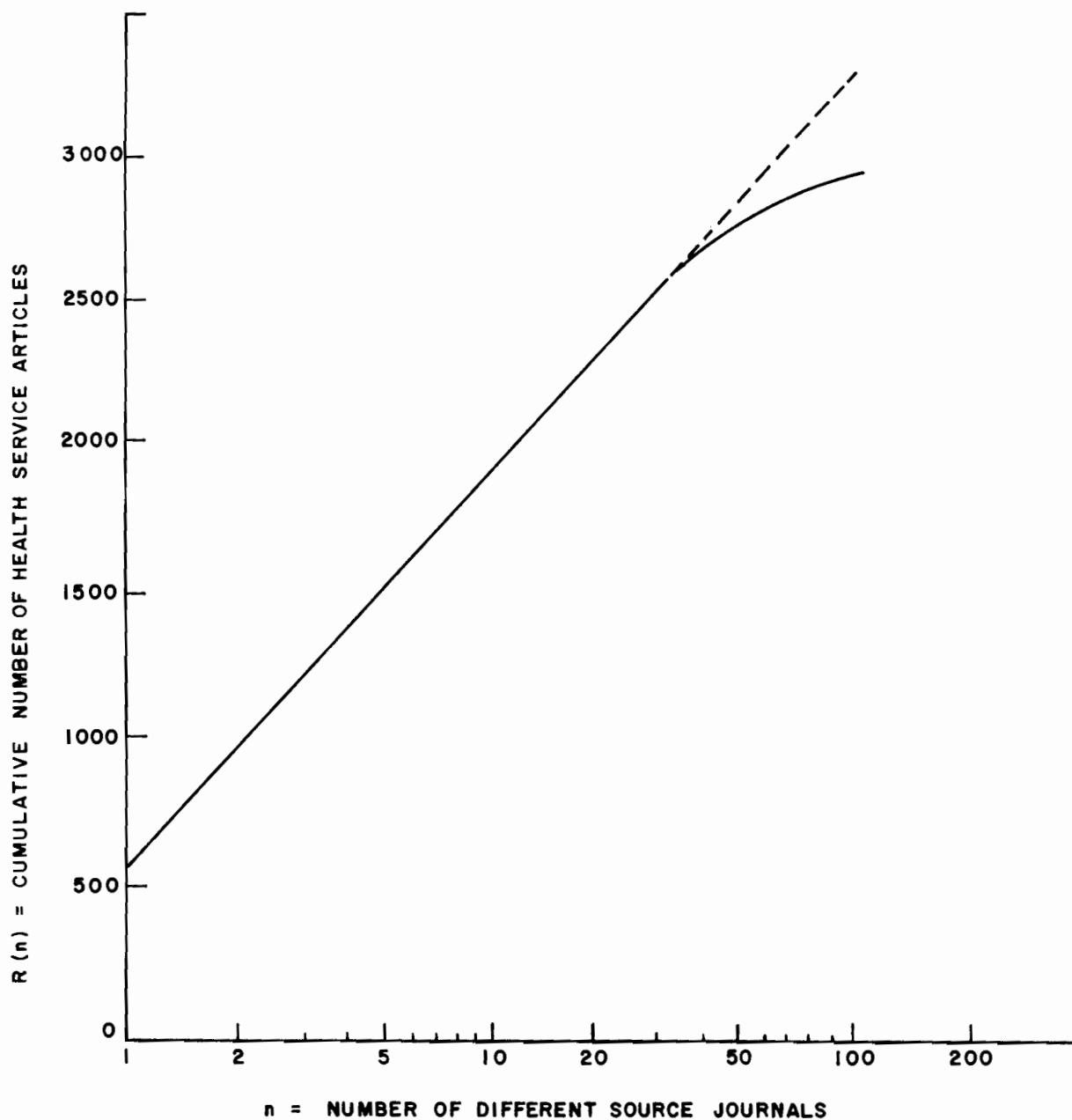

FIGURE 2-4

BRADFORD PLOT OF HEALTH SERVICES ARTICLES DISTRIBUTION

collection of journals or an optimum system of libraries.

A few of the papers dealing with Bradford's Law and its applicability are listed below. The list is abbreviated, and the references in these papers will lead the reader to dozens of other papers on Bradford's Law, which itself constitutes an entire subfield of bibliometrics.

Brookes, B.C. "Bradford's Law and the Bibliography of Science." Nature 224 (December 1969):953-956.

Brookes, B.C. "The Complete Bradford-Zipf Bibliograph." Journal of Documentation 25 (March 1969):58-61.

Brookes, B.C. "The Derivation and Application of the Bradford-Zipf Distribution." Journal of Documentation 24 (December 1968):247-265.

Brookes, B.C. "The Design of Cost-Effective Hierarchical Information Systems." Information Storage and Retrieval 6 (1970):127-136.

Brookes, B.C. "Optimum P % Library of Scientific Periodicals." Nature 232 (August 1971):458-459.

Brookes, B.C. "Scientific Bibliography." (letter) Nature 227 (September 1970):1377.

Cole, P.F. "A New Look at Reference Scattering." Journal of Documentation 18 (June 1962):54-64.

Fairthorne, Robert A. "Empirical Hyperbolic Distributions (Bradford-Zipf Mandelbrot) for Bibliometric Description and Predicting," Journal of Documentation 25 (December 1969):319-343.

Goffman, William, and Warren, Kenneth S. "Dispersion of Papers Among Journals Based on a Mathematical Analysis of Two Diverse Medical Literatures." Nature 221 (March 1969):1205-1207.

Goffman, William, and Morris, Thomas G. "Bradford's Law and Library Acquisitions." Nature 226 (June 1970):922-923.

Kendal, M.G. "The Bibliography of Operational Research." Operational Research Quarterly 11 (March/June 1960):31-36.

- Krevit, Beth and Griffith, Belver C. "A Comparison of Several Zipf Type Distributions in their Goodness of Fit to Language Data." Journal of the American Society for Information Science (May-June 1972):220-221.
- Lawani, S.M. "Bradford's Law and the Literature of Agriculture." International Library Review 5 (1973):341-350.
- Leimkuhler, Ferdinand F. "The Bradford Distribution." Journal of Documentation 23 (September 1967): 197-207.
- Narahan, S. "Bradford's Law of Bibliography of Science: An Interpretation." Nature 227 (August 1970):631-632.
- Smith, David A. "The Ambiguity of Bradford's Law." (letter) Journal of Documentation 28 (September 1972):262.
- Vickery, B.C. "Bradford's Law of Scattering." Journal of Documentation 4 (1948):198-203.
- Wilkinson, Elizabeth A. "The Ambiguity of Bradford's Law." Journal of Documentation 28 (June 1972): 122-130.
- Worthen, Dennis B. "The Application of Bradford's Law to Monographs." Journal of Documentation 31 (March 1975):19-25.

The main evaluative use of the Bradford technique is to provide an estimate of the number of journals which will have to be searched in order to have reasonable confidence that a study based on a given set of papers covers an accurately known fraction of the entire literature in the given subject area. As such, it is an important tool.

There are certain subtle aspects of using Bradford's work which are often overlooked, including the fact that a distribution based on all the articles in the literature over 5 years, such as one shown in Figure 2-4, would not be the same as a distribution constructed by adding together searches for five individual years. As a result, although one has to use the Bradford distribution carefully, it can be a very important tool in estimating the size of a collection of papers in a given subject.

Bradford's work was directed toward the librarian. The next event shown on Figure 2-1 was oriented toward policy and evaluation, and signals the beginning of current interest in the sociology of science and in the growth of the scientific literature.

In 1961 Derek J. de S. Price first published his book Science Since Babylon, followed in 1963 by a related work Little Science, Big Science.¹⁷ These two books are readable, informative, delightful, and required reading for anyone seriously interested in evaluative bibliometrics. They also show, at times, a rather cavalier disregard for the limitations and lack of precision in much bibliometric data. Nevertheless the books beautifully portray and define the boundaries of the scientific enterprise. The work on which this monograph is based, and the work of others since, has been devoted to mapping the internal structure of the scientific universe whose bounds were neatly outlined by Price.

In Science Since Babylon, in a Chapter entitled "Diseases of Science", Price shows that the number of journals founded (but not necessarily surviving) grew exponentially from 1750 through 1950. Figure 2-5, from that chapter, shows this growth; Price described it in the following way:

It is apparent, to a high order of accuracy, that the number has increased by a factor of ten during every half century, starting from a state in 1760 when there were about ten scientific journals in the world.¹⁸

He also discussed the rise of the abstract journal, which was a response to the flood of journals, which in turn has been a response to the flood of papers, and states:

But by about 1830 there was clearly trouble in the learned world, and with an assemblage of some 300 journals being published, some radically new effort was needed. Yet again there was an invention as deliberate and as controversial as the journal itself: the new device of the abstract journals appeared on the scene.

¹⁷Derek J. de Solla Price, Science Since Babylon, enl. ed., (New Haven: Yale University Press, 1975).

Derek J. de Solla Price, Little Science, Big Science, (New Haven: Yale University Press, 1963).

¹⁸Price, Science Since Babylon, p. 165.

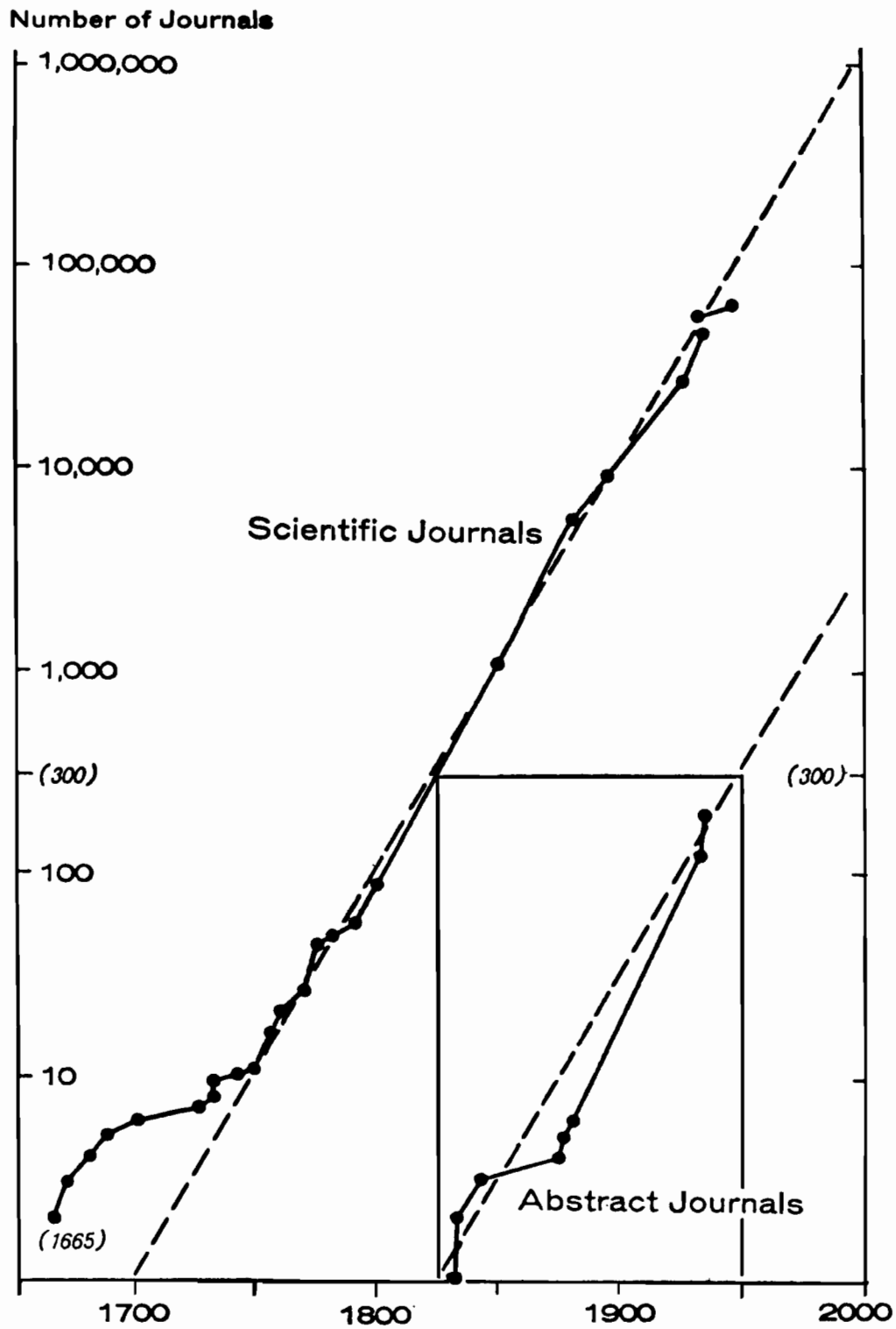

FIGURE 2-5

NUMBER OF JOURNALS FOUNDED AS A FUNCTION OF DATE
 (from Price, Science Since Babylon, 1975)

...the number of abstract journals has also increased, following precisely the same law, multiplying by a factor of ten in every half century.¹⁹

Price also shows a curve for the growth of Physics Abstracts since 1900, which displays the same exponential growth, and refers to a number of other specific studies of special literature. He comments that this growth cannot go on forever, and begins to discuss the inevitable leveling of the growth of scientific journals and papers which may well be occurring today.

In Little Science, Big Science, Price goes further into the laws of growth, and makes a number of observations about the immediacy of science which results from such rapid growth:

...so large a proportion of everything scientific that has ever occurred is happening now, within living memory. To put it another way, using any reasonable definition of a scientist, we can say that from 80 to 90 percent of all scientists that have ever lived are alive now.²⁰

He also provides some lists of the order of magnitude of doubling times, which point out how rapidly the growth of science and technology has been outstripping that of the population and other non-scientific institutions. For example, Price gives the following doubling times:

100 years

Entries in dictionaries of national biography

50 years

Labor force
Population
Number of universities

20 years

Gross National Product
Important discoveries
Important physicists
Number of chemical elements known
Accuracy of instruments
College entrants/1000 population

¹⁹Price, Science Since Babylon, p. 167.

²⁰Price, Little Science, Big Science, p. 1.

15 years

B.A., B.Sc.
Scientific journals
Membership of scientific institutes
Number of chemical compounds known
Number of scientific abstracts, all fields

10 years

Number of asteroids known
Literature in theory of determinants
Literature in non-Euclidean geometry
Literature in X-rays
Literature in experimental psychology
Number of telephones in United States
Number of engineers in United States
Speed of transportation
Kilowatt-hours of electricity

5 years

Number of overseas telephone calls
Magnetic permeability of iron

1 1/2 years

Million electron volts of accelerators

At the time Price was publishing these books, two somewhat related studies were published, both of which dealt with the current size of the world's periodical literature. The first of these, written by C.P. Bourne in 1962, estimated the volume, origin, language, field, and indexing and abstracting of the world's technical journal literature.²¹ Bourne estimated the total volume of the literature at 30,000 to 35,000 journals, based on some advance knowledge of Gottschalk and Desmond's paper to be described next. Bourne then says a more realistic estimate points to a world-wide publication of about 15,000 "significant" journals and 1,000,000 "significant" papers per year.

Figure 2-6, taken from that publication, graphically summarizes a vast amount of subject and language data.

Bourne's paper, while providing a large amount of information, is based on an aggregation of data from many different sources; as such, it contains all of the problems of overlap between abstracting services and fields, and all the other complexities involved when the possibility of counting the same

²¹ Charles P. Bourne, "The World's Journal Literature: An Estimate of Volume, Origin, Language, Fields, Indexing, and Abstracting," American Documentation (April 1962):159-168.

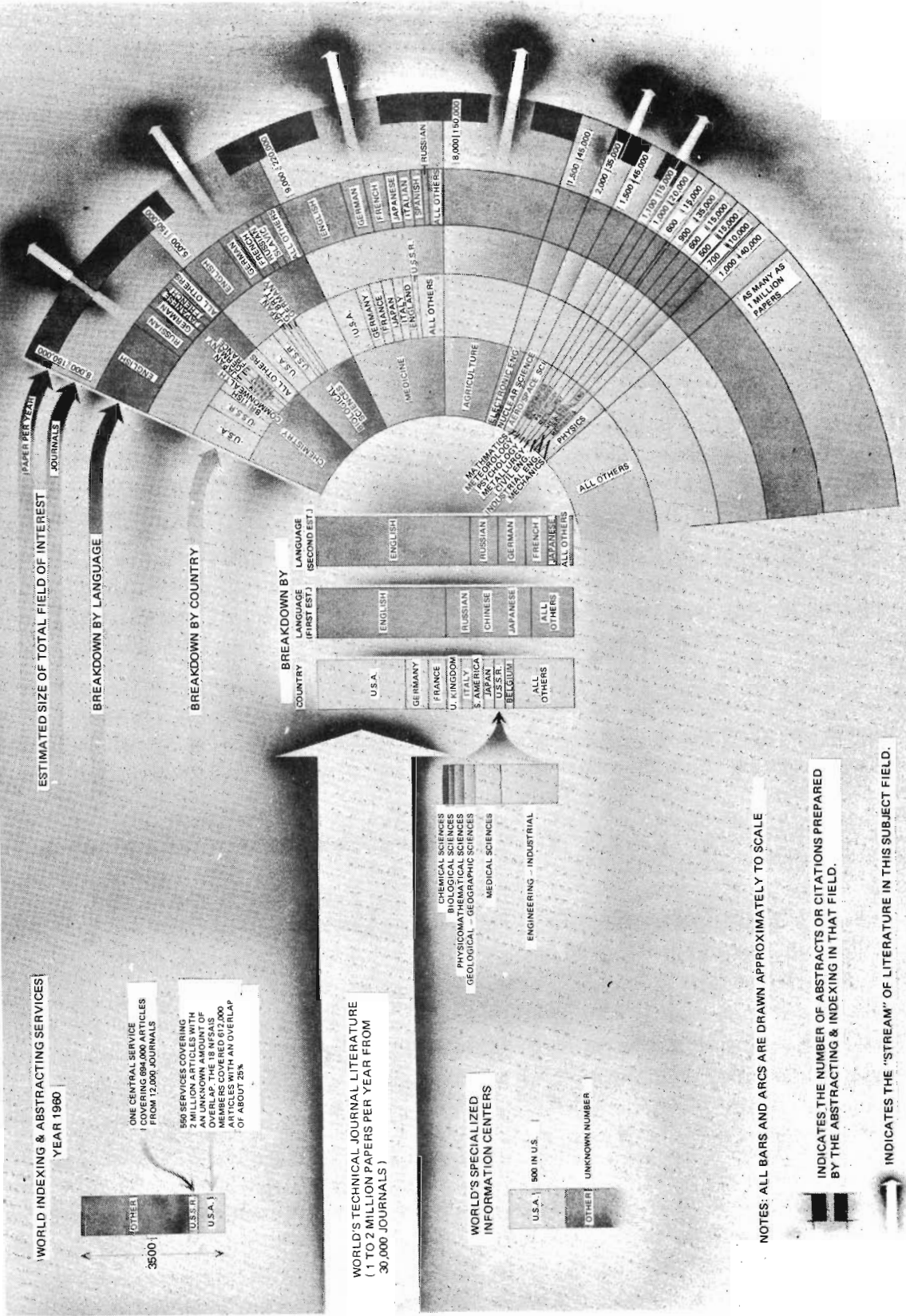

FIGURE 2-6

CURRENT COMPOSITION OF THE WORLD'S
TECHNICAL JOURNAL LITERATURE
(from Bourne, 1962)

thing a number of times is introduced. Nevertheless, the paper clearly distinguishes many basic characteristics of the literature including such observations as:

English is still the predominant language, comprising about one half of the total production. There are indications that Russian may be coming abreast of the traditional French and German. From a nationalistic standpoint, the published reports indicate that the United States still produces the greatest volume of literature, followed by Germany, France and the United Kingdom, in that order.²²

Bourne also remarks that

The relative proportions for each country appeared to differ markedly in the various specialty fields. The Soviet literature, for example, seems to be very prominent in chemistry, but relatively light in other fields such as medicine.²³

These general observations have been borne out by subsequent studies.

Bourne's count of 35,000 journals comprising the world's total technical journal literature was based on the census of scientific and technical periodicals published by Gottschalk and Desmond in 1963.²⁴ To avoid the problems of overlap and omission and of inclusion of technical reports, house organs, and such, Gottschalk and Desmond

...decided to comb the most comprehensive and recent serial listings of each country for current titles.²⁵

The results of their counts, shown in Table 2-3, indicate a total of approximately 35,000 current scientific and technical serials published.

²²Ibid., p. 160.

²³Ibid., p. 160.

²⁴Charles M. Gottschalk and Winifred F. Desmond, "World-wide Census of Scientific and Technical Serials," American Documentation 14 (July 1963):188-194.

²⁵Ibid., p. 189.

TABLE 2-3

TOTAL NUMBER* OF CURRENT SCIENTIFIC AND
 TECHNICAL SERIALS PUBLISHED AS OF 1961
 (from Gottschalk & Desmond, 1962)

Africa (continent)	650	Netherlands	650
Australia	450	New Zealand	150
Austria	500	Norway	250
Belgium	1,250	Pakistan	100
Bulgaria	150	Philippines	100
Canada	550	Poland	750
China (People's Republic)	650	Portugal	250
China (Republic)	200	Rumania	150
Czechoslovakia	400	Spain	300
Denmark	400	Sweden	700
Finland	300	Switzerland	800
France	2,800	Thailand	50
Germany (East and West)	3,050	Turkey	100
Greece	50	U.S.S.R.	2,200
Hungary	250	United Kingdom	2,200
India	650	United States	6,200
Indonesia	100	Yugoslavia	400
Ireland	50	Other countries	400
Italy	1,500		
Japan	2,800		
Korea (Democratic People's Republic)	50		
Korea (Republic)	100		
Latin America (Caribbean area, Central and South America, Mexico)	2,650		
		TOTAL:	35,300

*Figures have been rounded off to the nearest 50. Those countries which published fewer than 50 journals have been grouped together under "Other countries".

The error has been estimated as $\pm 10\%$ due to selection based on titles rather than serials, the incompleteness of listings chosen, and the undetermined mortality rate.

In 1967, K.E. Barr at the National Lending Library of Science and Technology in Boston Spa, England, published a paper based on a 1965 list of currently available scientific and technical periodicals.²⁶ His estimate, based on the experience of the NLL in attempting to build a comprehensive collection of the world's scientific literature, was 26,000 currently available scientific and technical periodicals, covering the NLL's original fields of science and technology in general, including agriculture and medicine. NLL excludes house organs and publishers' series, but does include the technical report literature, proceedings of international organizations, and cover-to-cover translations. In 1967 the library excluded most of the social sciences, drawing a line between experimental psychology which it included, and the rest of psychology which it excluded.

The Bourne paper appears to be the first census based on the actual existing collection of journals. One of the reasons that the NLL total is considerably lower than Gottschalk and Desmond's is that the NLL census is based on currently available periodicals, while a periodical which has ceased publication may not disappear from a national listing for a considerable period of time. Table 2-4 summarizes the counts for NLL serials on order in December of 1965.

In the late 1960s Price initiated a series of advances in the evaluative use of the scientific literature by showing the correlation between the scientific productivity of a country and its gross national product (GNP). This correlation was a major crystallization of the association between scientific and economic activity, which had been first noted by Hulme some 40 years before, and had been hinted at in Price's earlier work. In his papers "Measuring the Size of Science" and "Nations Can Publish or Perish", Price shows that, to a first approximation,

The share each country has of the world's scientific literature by this reckoning turns out to be very close - almost always within a factor of 2 - to that country's share of the world's wealth (measured most conveniently in terms of GNP). The share is very different from the share of the world's population, and is related significantly more closely to the share of wealth than to the nation's expenditure on higher education.²⁷

²⁶ K.P. Barr, "Estimates of the Number of Currently Available Scientific and Technical Periodicals," Journal of Documentation 23 (June 1967):110-116.

²⁷ Derek J. de Solla Price, "Measuring the Size of Science," Proceedings of the Israel Academy of Science and Humanities 6 (1969):10-11.

TABLE 2-4

NLL SERIALS ON ORDER, DECEMBER 1965
 (adapted from Barr, 1967)

	<u>TOTAL</u>
USUALLY ENGLISH LANGUAGE	
U.K., Eire	2,900
U.S.A.	4,900
Canada	650
Australia, New Zealand	650
India, Pakistan, Ceylon	750
Africa	550
EUROPEAN	
U.S.S.R.	1,950
East European	1,900
Germany, Austria	2,100
Benelux	1,100
Switzerland	450
Scandinavia	1,150
France	1,350
Italy	1,000
Spain, Portugal	500
OTHERS	
South and Central America, Atlantic	1,550
Near East	300
Japan	1,650
China	100
Indonesia	100
Rest of Asia	<u>150</u>
TOTALS	25,750

Price also asserts that 0.7% of gross national products devoted to basic research in science is required as a "universal admission price to the scientific arena", after which a country may have a sustained scientific effort.

The data base Price used to measure the size of science was the International Directory of Research and Development Scientists (IDRDS), published by the Institute for Scientific Information (ISI) in 1967. The directory lists the name and address of each scientist who is a first author of a paper listed in Current Contents during the year 1967. Unfortunately, IDRDS does not list the journal from which the paper came, so that there is no way of using IDRDS to see the difference between publication rates in different scientific fields. Further, different publication rates in different fields or countries are obscured because IDRDS lists an author's name only once even if he authored many papers.

Figure 2-7 shows this measure of scientific size compared to GNP. The magnitude of the spread is quite apparent and understandable given some of the approximations in the data; however, there is little doubt that Price's basic point, that scientific size varies with GNP, holds for a substantial number of countries.

Another problem, the seriousness of which is still difficult to estimate quantitatively, is the under-representation of the publications of the smaller countries within the general ISI data base. The ISI data tend to exclude the more specialized and less central journals from the smaller countries, and they may do this in a non-uniform way. Since the IDRDS probably covered less than 20% of the 25,000 or so journals in existence in 1967, there is a clear potential for bias in the data. This bias is probably not serious for the top 20 or 30 countries; however, while the 2,000 Science Citation Index (SCI) journals (the heart of the Current Contents' coverage) represent the bulk of internationally significant science and the rest of Current Contents journals provide a link with less central scientific work, the omission of some 80% of the world's scientific journals is a significant limitation. Unfortunately, there are no data in Price's papers on either the number of journals covered, or any biases in the data base. The world total of authors given, 126,055, is almost an order of magnitude smaller than estimates of the number of papers published annually.

After Price's work in the late 1960s, the use of bibliometric indicators in evaluative work appeared to lie quiescent for a few years. In 1972 I.S. Speigel-Rosing²⁸ used the IDRDS

²⁸I.S. Spiegel-Rosing, "Journal Authors As An Indicator of Scientific Man-Power; a Methodological Study Using Data from the Two Germanies and Europe," Science Studies 2 (1972): 337-359.

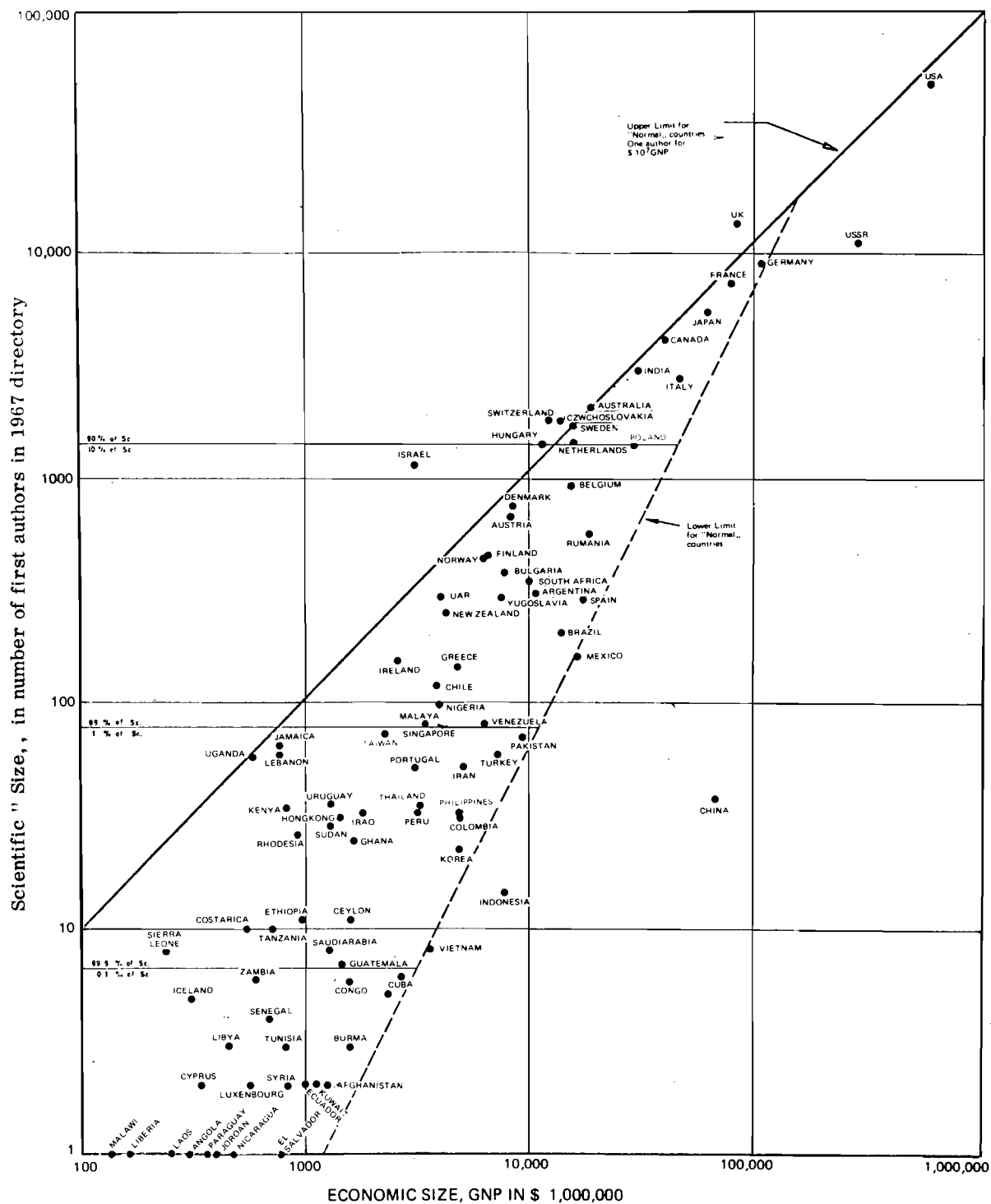

Figure does not include 24 small countries (GNP from 50 to 1800 million dollars) totaling 0.5% world GNP but with no scientists on directory in 1957.

FIGURE 2-7

NATIONAL SCIENTIFIC SIZE VS. NATIONAL ECONOMIC SIZE
(from Price, 1965)

(WIPIS)* data base to study scientific productivity in the Federal Republic of Germany (FRG) and the German Democratic Republic (GDR). She finds striking differences between the publication patterns of the two Germanies, the FRG has 5 to 6 times the number of entries in WIPIS; a greater fraction of the FRG scientists are university affiliated; and, on a population basis, the FRG has about 1.9 WIPIS authors/10,000 inhabitants in 1970, while GDR has 1.1.

In 1972 the National Science Board published its report Science Indicators 1972, with a section on the use of scientific publications as an output measure in science.²⁹ The National Science Board notes that:

There are certain relatively direct results of R&D which provide indicators for comparing the scientific and technical performance of nations. Primary among these are reports of research published in scientific and technical journals, citations of reports from these journals, and patents for new products and processes.³⁰

Computer Horizons, Inc. prepared the data for the publication and citation sections of Science Indicators 1972 and prepared similar data for the 1974 Science Indicators report. Computer Horizons' 1975 paper "National Publication and Citation Comparisons" discusses the publication and citation data used in the Science Indicators reports.³¹

For the Science Indicators report, indicators of national scientific activities were derived from counts of 500,000 publications and millions of citations in 492 large and heavily cited scientific journals in seven major disciplines, for six major countries, during a time span from 1965 to 1971. The counts identified the country of origin of the authors in each

*Since 1970, IDRDS has been renamed Who is Publishing in Science (WIPIS).

²⁹ National Science Board, Science Indicators 1972 (Washington, D.C.: National Science Board, 1973).

³⁰ Ibid., p. 5.

³¹ Francis Narin and Mark Carpenter, "National Publication Citation Comparisons," Journal of the American Society for Information Science 26 (March-April, 1975):80-93.

of the 500,000 publications by his current address, as Price had done in his IDRDS work. In addition, since the analysis was based upon the Science Citation Index tapes themselves, it was possible to count the number of publications by journal, and thus to classify these publications by major scientific disciplines.

These counts indicated a first rank position for the U.S. in scientific publication, followed at a significant distance by the Soviet Union. Ranked below the U.S. and the U.S.S.R. were the United Kingdom and Germany, followed by Japan and France. The national publication rankings vary widely from discipline to discipline; for instance, Soviet chemistry ranks high, physics moderate, and biology notably low. The study also found that the U.S. was by far the most highly cited country, followed by the U.K.; Germany and Japan were cited at a middle level, with French and Soviet publications the least heavily cited.

As a means of checking the overall representativeness of the Science Citation Index sample, the 1972 counts of publications in 492 journals (by national origin) were compared with counts in 2,143 SCI covered journals, and with equivalent publication by country counts in the major abstracting services, to see whether there were any major biases in the SCI coverage on a discipline by discipline basis.

Table 2-5 shows that comparison. In the SCI data for mathematics, the Soviet Union seems under-represented and the United States over-represented. For physics and geophysics, molecular biology, psychology and engineering the SCI data are quite close to those of the corresponding abstracting services: Physics Abstracts (PA), Biological Abstracts (BA), Psychological Abstracts (PSA), and the Engineering Index (EI). For chemistry and metallurgy, adding publication counts from a relatively small number of large Soviet journals which were not covered by SCI resulted in a reasonably good match between the SCI data and the abstracting services data. For systematic biology, Biological Abstracts and the SCI data differ substantially.

In both mathematics and systematic biology the difference between the SCI coverage and the abstracting service coverage seems to be due to the very large numbers of relatively small journals characterizing the discipline; thus there is no easy way for Computer Horizons or for ISI to provide balanced coverage in those fields without an effort which would be out of proportion to the size of the disciplines.

The first study which measured how frequently each countries' publications were cited by other countries was reported in Computer Horizons' "National Publication and Citation Comparisons." The results of that study showed that the very great majority of references were from journals in one discipline to other journals

TABLE 2-5

COMPARISON OF PUBLICATION AND ABSTRACT COUNTS FOR 1972
(from Narin & Carpenter, 1975)

	Product Moment Correlations									
	U.S.	U.K.	W.Ger.	France	U.S.S.R.	Japan	Other	2143 SCI Journals vs. Abstract Services	492 SCI Journals vs. Abstract Services	0.96
Math.	50.7	9.2	2.6	8.3	8.2	3.0	18.1	0.63	0.67	
	49.9	8.5	4.0	9.4	5.1	3.0	20.1			
	29.3	3.9	5.5	5.6	28.6	5.0	22.0			
Phys./Geoph.	38.5	7.7	5.2	6.1	15.1	5.6	21.7			
	35.6	7.6	5.2	5.9	17.2	5.5	23.0	0.98	0.96	
	31.3	9.0	4.1	5.8	19.1	7.0	23.7			
Chem./Met.	29.8	9.3	7.3	8.0	6.7	8.0	30.9			
	32.1	10.1	6.5	8.4	8.0	7.1	27.8	0.63	0.57	
	26.3	9.8	7.0	3.4	27.1	6.6	19.8			
Chem./Met.	22.4	7.0	5.4	6.0	30.1	6.0	23.2			
	23.3	7.3	5.3	5.7	26.2	7.0	25.1	0.96	0.96	
	26.3	9.8	7.0	3.4	27.1	6.6	19.8			
M-Bio.	45.9	9.7	4.4	9.6	1.8	5.4	23.3			
	42.1	9.1	5.9	5.9	5.1	4.9	27.0	0.98	0.94	
	39.4	7.8	5.5	3.5	9.6	5.8	28.5			
S-Bio.	43.9	11.6	3.3	2.0	0.4	1.8	37.1			
	47.7	10.9	2.5	2.3	1.6	1.5	33.4	0.88	0.93	
	31.2	6.5	4.0	5.5	2.5	5.0	45.3			
Psych.	74.4	8.5	0.7	0.2	0.2	0.9	14.9			
	74.5	8.0	0.9	0.8	0.8	0.7	14.2	0.99	0.99	
	76.6	3.8	1.5	2.7	1.7	0.4	13.3			
Eng.	44.6	9.7	6.4	2.4	11.4	3.9	21.7			
	44.8	11.8	6.8	2.1	7.2	4.4	22.9	0.95	0.98	
	36.6	11.0	9.4	2.8	16.2	3.8	20.2			

*(WJ) Augmented Data: = weighted journal country attribution.

All papers assumed to be from country of origin of journals.

MR = Mathematical Review

PA = Physics Abstracts

CA = Chemical Abstracts

BA = Biological Abstracts

PSA = Psychological Abstracts

EI = Engineering Index

in the same discipline. If citations to a discipline only from within that discipline are considered, a citation-to-publication measure from one country to another can be defined for the discipline. As an example, the citation-to-publication measure for references from French to German physics would be:

Citation measure for French to German physics =

$$\frac{\% \text{ of references from French physics which are to German physics}}{\% \text{ of physics publications which are German}}$$

Table 2-6 presents the citation-to-publication measures from the various countries to the U.S. in the various disciplines. The U.S. position is high in most fields, since most entries in the table are > 1 , indicating more citations to U.S. publications than their number alone would warrant. Only three disciplines -- systematic biology, psychology, and engineering -- are not cited to this degree by outside countries. U.S.S.R. citations to the U.S. are lower than those from other countries. In the large and important disciplines of physics, chemistry, and molecular biology, the U.S. is particularly highly cited by the rest of the world. The high rate of utilization of U.S. work by U.S. scientists is also apparent from the top row of the table.

For the bottom row of the table all references from countries other than the U.S. were combined. This row represents the utilization of U.S. publications by the outside world as a whole. The utilization is visibly high.

Table 2-7 presents the citation-to-publication measure for within-country citation. That a fellow countryman's work is more likely to be cited is clear from the prevalence of numbers much larger than one. Very large numbers, such as those in some disciplines for the Soviet Union, become possible when the fraction of a discipline's publications produced by that country is very small. The fact that there is always a within-country bias, while the citation/publication measures for the citation to U.S. from the outside world are still generally greater than one, further indicates the outstanding influence of the U.S. literature.

That the U.S. literature is indeed very highly cited is confirmed in Table 2-8, which presents the measure for outside-of-country citation for each country in each discipline. This measure is higher in all fields for the U.S. than for any other country, with a single exception; systematic biology, where the measure for the U.K. exceeds that for the U.S.

In conclusion it should be noted that the use of the scientific literature in characterizing international scientific activity is growing. Researchers working in this field are now

TABLE 2-6

CITATION TO PUBLICATION MEASURE FOR CITATION TO THE U.S.
 (from Narin & Carpenter, 1975)

Citing Country	Cited and Citing Discipline							
	Math.	Eng.	Phys.	Chem.	M.Bio.	Med.	S.Bio.	Psych.
U.S.	1.34	1.49	1.53	1.87	1.53	1.61	1.38	1.09
U.K.	1.08	1.00	1.40	1.47	1.31	1.03	.74	.86
W. Germany	1.10	.89	1.24	1.20	1.21	1.02	.79	.93
France	.88	1.16	1.23	1.33	1.27	1.19	.78	1.03
U.S.S.R.	.64	.38	.66	.83	1.06	1.00	.56	.62
Japan	1.08	1.18	1.43	1.46	1.31	1.45	.86	1.02
World	1.24	1.20	1.32	1.47	1.41	1.34	1.12	1.06
Non-U.S.	1.11	.96	1.22	1.31	1.30	1.13	.88	.95

TABLE 2-7

CITATION TO PUBLICATION MEASURE WITHIN EACH COUNTRY
(from Narin & Carpenter, 1975)

To	From	Discipline							
		Math.	Eng.	Phys.	Chem.	M.Bio.	Med.	S.Bio.	Psych.
U.S.	U.S.	1.34	1.49	1.53	1.87	1.53	1.61	1.38	1.09
U.K.	U.K.	2.46	2.05	1.48	1.57	1.67	2.08	3.18	2.49
W. Germany	W. Germany	2.95	3.94	1.71	4.10	1.89	2.72	4.78	8.11*
France	France	3.33	5.24	1.22	2.60	1.86	3.48	5.53	3.45*
U.S.S.R.	U.S.S.R.	10.20	9.95	3.05	2.54	4.54	9.65*	26.47*	42.85*
Japan	Japan	8.00	3.63	3.20	2.02	2.85	3.02*	6.69*	4.68*
Other	Other	1.15	1.18	1.05	1.12	.83	.93	1.10	1.12

*Indicates "Cited Country's Publications in Field/Total Publication in Field" < .02

TABLE 2-8

CITATION TO PUBLICATION MEASURE FROM OUTSIDE EACH COUNTRY
(from Narin & Carpenter, 1975)

TO	From	Discipline							
		Math.	Eng.	Phys.	Chem.	M. Bio.	Med.	S. Bio.	Psych.
U.S.	Non-U.S.	1.11	.96	1.22	1.31	1.30	1.13	.88	.95
U.K.	Non-U.K.	.93	.62	.82	.93	1.06	.93	.99	.75
W. Germany	Non-W.Ger.	.95	.45	.82	1.27	.52	.28	.64	.44*
France	Non-France	.18	.68	.64	.62	.41	.27	.52	.34*
U.S.S.R.	Non-U.S.S.R.	.14	.20	.33	.13	.09	.08*	.24*	.14*
Japan	Non-Japan	.64	.78	.64	.66	.67	.74*	.61*	.35*
Other	Non-Other	.86	.74	.81	.79	.68	.67	.69	.88

*Indicates "Cited Country's Publications in Field/Total Publication in Field" < .02

developing far more revealing and comprehensive methodologies for measuring international scientific activity. For example, a recent paper by Inhaber uses potential theory to graph the distribution of scientists throughout the world.³² Figure 3 from Inhaber's work shows the high concentration of scientists/population in Europe and North America. Other on-going work has been reported in Science Indicators 1974, and other parts will be reported in Science Indicators 1976.

³² H. Inhaber, "Distribution of World Science," to be published in Geoforum 6 (January 1976).

III. STRUCTURE OF THE SCIENTIFIC LITERATURE

The definition of the detailed structure of the scientific literature, and its component subject disciplines, has its origin in almost 50 years of research interest. The main ideas in this research area are summarized in Figure 3-1, a tracing of the key papers.

The first impetus for the analysis of scientific journals came from the needs of the library. In a modest paper published in 1927, P.L.K. Gross and E.M. Gross seem to have originated the concept of using the references in a scientific journal to identify the key journals in a subject or discipline.¹ Their paper is shown at the top of Figure 3-1, as the first paper on the structure of the scientific literature at the level of the scientific journal. Gross & Gross' paper considered the adequacy of library facilities at Pomona College in California; in particular, Gross & Gross were worried about the problems their students would encounter upon entering graduate schools in competition with students from the expanding major universities with their massive central libraries.

Faced with budgetary and space limitations at Pomona they discussed the problem of choosing the most important chemical periodicals. Gross & Gross talked of the possibility of manually compiling such a list but then pointed out the limitations of all such subjective activities stating that "often the results would be seasoned too much by the needs, likes, and dislikes of the compiler".² They then went to a more objective technique, analyzing the references from the most recent complete volume (1926) of the Journal of the American Chemical Society (JACS). They tabulated the references to the most frequently cited periodicals over five-year intervals, introducing the concepts of ranking journals by their frequency of citation and of the importance of time distributions. They noted that the most frequently cited journal over all time (excluding JACS) is the German Berichte der Deutschen Chemischen Gesellschaft. On the other hand, the British Journal of the Chemical Society is the most frequently cited in the 1921 to 1925 time period. They also noted the frequency of citations to journals in other languages (52% of the foreign periodicals were in the German language) and thus recognized some of the international aspects of the chemical literature.

Gross & Gross' paper was followed by a veritable burst of papers throughout the next decades, counting references from different journals and groups of journals, and using these reference

¹P.L.K. Gross and E.M. Gross, "College Libraries and Chemical Education," Science 66 (1927):385-389.

²Ibid., p. 386.

1900		
1910		
1920		
	Gross & Gross, Pomona College, 1927	
	First Tabulation of Citations to Journals	
1930		
	Cason & Lubotsky, U. Wisconsin, 1936	
	Journal to Journal Cross Citation	
	Influence for Journals and Fields	
1940		
	Fussler, U. Chicago, 1949	
	Citations to Journals, Countries and Fields	
1950		
	Daniel & Louttit, U. Missouri, U. Illinois, 1953	
	Cluster Analysis and Mapping of Journals	
1955		
1960		
	Kessler, MIT, 1962, 1964	
	Bibliographic Coupling Relates Papers	
	Journal to Journal Cross Citation	
1965		
	Xhighnesse & Osgood, U. Illinois, 1967	
	Graphic Representation of Referencing Similarities	
1970		
	Garfield, ISI, 1972	Narin, Carpenter & Berlt,
	Citation Impact Measures	Computer Horizons, Inc., 1972
	for Hundreds of Journals	Journal and Field Citation Maps
		for Hundreds of Journals
	Carpenter & Narin, Computer	Small and Griffith, ISI and
	Horizons, Inc. 1973	Drexel, 1973 and 1974
	Cluster Analysis and Maps	Co-citation Measures Interactive
	for Hundreds of Journals	Specialty Areas
1975		
	Cox, Hamelman & Wilcox	
	Virginia polytechnic Institute, 1976.	
	Multi-dimensional Scaling Applied	
	to Business Journals	

FIGURE 3-1

IMPORTANT PAPERS ON THE STRUCTURE OF THE SCIENTIFIC LITERATURE

counts to comment upon frequency of citation, nationality, and language for various journal literatures. While these papers added descriptive information, and extended the reference counting technique to different fields, they did not seem to introduce many original ideas on the use of citation measures. Some of these papers include:

- Allen, Edward S. "Periodicals for Mathematicians." Science 70 (December 1929):592-594.
- Barrett, Richard L. and Barrett, Mildred A. "Journals Most Cited by Chemists and Chemical Engineers." Journal of Chemical Education 34 (January, 1957):35-38.
- Burton, Robert E. "Citations in American Engineering Journals I. Chemical Engineering." American Documentation (1959):70-73.
- Brown, Charles Harvey. Scientific Serials Chicago: Association of College and Reference Libraries (ACRL Monograph No. 6) 1956. Covers botany, chemistry, physics, physiology, mathematics, clinical pathology, soils, agronomy, astronomy, zoology, entomology, and geology. For most cases, he has two or more referencing years, often 1944 and 1954.
- Coile, Russell C. "Information Sources for Electrical and Electronics Engineers." IEEE Transactions on Engineering Writing and Speech EWS-12 (October 1969):71-78.
- Coile, Russell C. "Periodical Literature for Electrical Engineers." Journal of Documentation 8 (December 1952):209-226.
- Croft, Kenneth. "Periodical Publications and Agricultural Analysis." Journal of Chemical Education 18 (1941):315-316.
- Dalziel, Charles F. "Evaluation of Periodicals for Electrical Engineers." Library Quarterly 7 (1937):354-372.
- Gregory, Jennie. "An Evaluation of Medical Periodicals." Medical Library Association Bulletin 25 (1937):172-188. (see also 1935)
- Hackh, Ingo. "The Periodicals Useful in the Dental Library." Medical Library Association Bulletin 25 (1936):109-112.

- Henkle, Herman H. "The Periodical Literature of Biochemistry." Medical Library Association Bulletin 27 (1938):139-147.
- Hooker, Ruth H. "A Study of Scientific Periodicals." Review of Scientific Instruments 6 (November 1935):333-338.
- Gross, P.L.K. and Woodford, A.O. "Serial Literature Used By American Geologists." Science 73 (June 1931):660-664.
- Jenkins, R.L. "Periodicals for Child-Guidance Clinics." Mental Hygiene 16 (1932):624-630.
- McNeely, J.K. and Crosno, C.D. "Periodicals for Electrical Engineers." Science 72 (July 1930):81-84.
- Sheppard, Oden E. "The Chemistry Student Still Needs A Reading Knowledge of German." Journal of Chemical Education 12 (October 1935):472-473.
- Simosko, Vladimir and Smith, Maurice H. "An Evaluation of Serial Publications in the Aerospace Fields." Sci-Tech News 25 (Spring 1971):5-9.
- Tolpin, J.G. et al. "The Scientific Literature Cited By Russian Organic Chemists." Journal of Chemical Education (May 1951): 254-258.
- Zwolinski, Bruno; and Rossini, Frederick. "Analysis of References in Critical Tables." Science 130 (December 1959):1743-1746.

Following Gross & Gross' work in the tracing (Figure 3-1) is an almost forgotten paper which made a number of advances in using the scientific journal to study the functioning of the scientific community. This paper, published by H. Cason & M. Lubotsky in 1936, discussed the influence and dependence of psychological journals, and seems to have been 30 to 40 years ahead of its time.³ Cason and Lubotsky mentioned that journal-to-journal citation analysis could be used "to secure a quan-

³Hulsey Cason and Marcella Lubotsky, "The Influence and Dependence of Psychological Journals on Each Other," Psychological Bulletin 33 (1936):95-103.

titative measure of the extent to which each psychological field influences and is influenced by each of the other psychological fields".⁴ Their study was limited to journals in the English language, and to that part of each journal which was published in 1933.

The Cason & Lubotsky work anticipated many other problems which still exist in journal analysis. They had some problems with changes in journal names, a phenomenon that can be a major problem when using today's computerized data bases. They worried about multiple references (op. cit.'s, etc.) in a single article, and the problem of placement of references throughout an article. In further anticipation of problems which still exist, they discussed the difficulty of attributing references to journals which apparently do not exist, a forerunner of the process of unifying the many thousands of variants of journal names which appear in the Science Citation Index.

While Cason & Lutotsky's work shows an appreciation of the mechanical problems of dealing with the citations, their real advance lies in the idea of constructing a cross-citing network. They summarized their data by constructing a 28 x 28 element table⁵ of the percent of references from each of the most significant journals to the others, with a summarized count of references to other publications. This seems to be the first time that the idea of a cross-citing network appears in the literature. They also took explicit note of the ratio of self-references within a journal to references to other journals. They used the various journal-to-journal referencing percentages to measure the "psychological nature of the journals" and pointed out that the physiological and psychiatric journals are much less "psychological" than the purely psychological journals themselves. They also implicitly recognized the hierarchical structure of the literature by pointing out that most of the references in the physiological journals are to other physiological journals, and that most of the references from journals in psychology to the physiological journals are from the experimental, animal, and abnormal journals. They remarked that "it appears odd that the authors of papers in J Physiol and Amer J Physiol should make no use of the material in the experimental, animal, and abnormal journals".⁶ They also remarked that the "psychoanalytic journals are quite low in the influence they exert on other journals, and the psychoanalytical journals refer to other abnormal journals much more frequently than the other ab-

⁴Ibid., p. 95.

⁵Ibid., p. 95.

⁶Ibid., p. 102.

normal journals refer to them".⁷

Thus the ideas of hierarchical structure and of journal and subfield influence appeared in the scientific literature as early as 1936.

The advent of World War II seems to have arrested work in publication and citation techniques as it did in many other scientific fields.

In 1949, two papers by Fussler at the University of Chicago signaled the post-war resurgence of interest in bibliometrics.⁸ Fussler's papers were written for the librarian, much as Gross and Gross' paper had been, and addressed the perennial questions for working libraries of optimal collection size, subject distribution, book selection policy, internal arrangement, and so forth. For the U.S. research literature in "pure" chemistry and physics, Fussler attempted to determine:

- (1) The importance of the literature of various subject fields to chemistry and physics.
- (2) The temporal span of this literature, especially that between the date of an original publication and the date at which it is known to have been used.
- (3) The principal forms of the literature used and their relative importance.
- (4) The national origins of the literature used in the United States.
- (5) The more important serial titles for each field.⁹

While many of the techniques used by Fussler were similar to those used before, his work was extensive, and he added an interesting twist. He used a preliminary selection of source

⁷Ibid., pp. 102-103.

⁸Herman H. Fussler, "Characteristics of the Research Literature Used by Chemists and Physicists in the United States," Library Quarterly 19 (January 1949):19-35.

Herman H. Fussler, "Characteristics of the Research Literature Used by Chemists and Physicists in the United States, Part II," Library Quarterly 19 (January 1949):119-143.

⁹Fussler, "Characteristics of the Research Literature," p. 20.

journals to generate this final list of source journals in the following manner: he took a few key journals and sampled their references; he then included as his final selection of source journals all of those U.S. titles contained in the most cited 90% of the titles (excluding abstract journals). Thus he not only systematically tabulated references, but he also systematically chose the central journals used to represent the fields themselves.

A very thorough 1953 review paper by Stevens on the characteristics of subject literatures synthesized many of the studies done to that date.¹⁰ Stevens summarized the following facets of the research area: title dispersion, subject dispersion, time span, language distribution, and form.

Daniel & Louttit's 1953 book signalled the post-war resurgence of interest in evaluative bibliometrics.¹¹ They discussed the development of modern psychology, including data on various literature growth rates; they then proceeded with a sophisticated analysis of the structure of the psychological literature. In particular, they formulated the journal-to-journal cross-citation matrix as Cason & Lubotsky had done. However, they went much further and developed formal measures of dependence and referencing similarity between different journals. Next, in what seems to be the first use of cluster analysis and the first use of mapping techniques for journals, they clustered the major psychological journals on the basis of similarities in citation patterns. Finally, they developed a three-dimensional representation of the clusters of psychological journals. Figure 3-2 shows their map of psychology journals, which they denote as a "General Nucleus" and an "Applied Nucleus". The figure is elegant enough to obviate any need for further comments.

The current developments in the structure of the scientific literature stem from work which began almost a decade after Daniel and Louttit, quite independently of that early and elegant representation.

In 1963 M.M. Kessler published a paper suggesting that bibliographic coupling, the sharing of one or more references by two documents, might be used as a method of grouping tech-

¹⁰R.E. Stevens, "Characteristics of Subject Literatures," Association of College and Reference Libraries Monograph No. 6 (1953):10-12.

¹¹Robert S. Daniel and C.M. Louttit, Professional Problems in Psychology, (New York: Prentice-Hall, 1953).

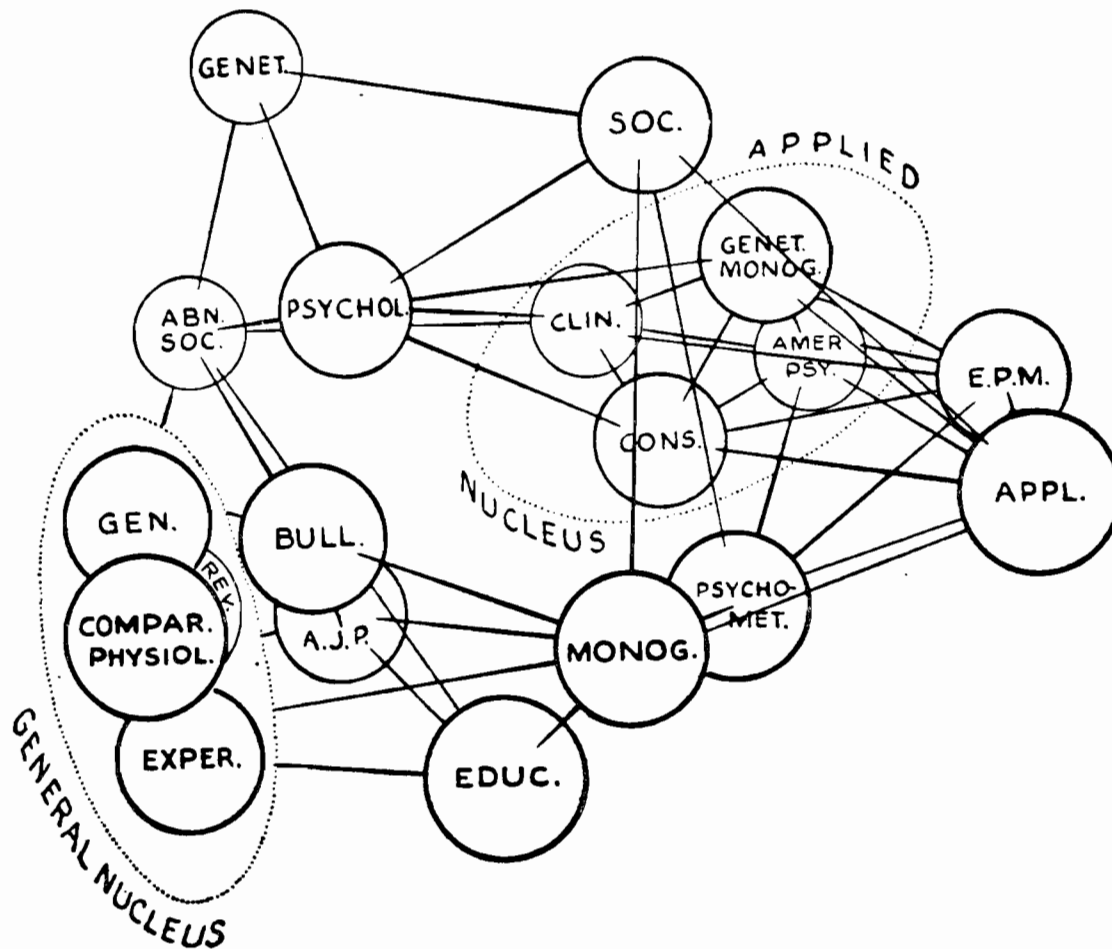

Three-dimensional representation of intercorrelations of psychology journals. Lines connect journals which are correlated .25 or more. Journals in the "general (or research) nucleus" are correlated about .95 with each other; those in the "applied (or professional) nucleus" about .80. The Psychological Monographs and the Journal of Psychology seem to serve as links between the general cluster on the left and the more complex cluster on the right.

FIGURE 3-2

THREE DIMENSIONAL REPRESENTATION OF INTERCORRELATIONS OF PSYCHOLOGY JOURNALS (from Daniel & Louttit, 1953)

nical and scientific papers.¹² Kessler suggested this as an automatic retrieval tool which would not require expert reading or judgment. Table 3-1, taken from that paper, shows pairs of papers that are strongly coupled. It is obvious that the technique is effective in identifying related papers.

In a 1964 paper on the cross-citation aspect of literature structure, Kessler formulated the journal-to-journal cross-citation matrix in mathematical form.¹³ Although the citations to and references from each journal were given in percentages, similar to Cason & Lubotsky's usage, the tone of the paper is far more mathematical than that earlier work. Kessler states that "...it is postulated that the properties of this matrix may be used to define a functionally related family of journals".¹⁴ He does not seem to have been aware of the Cason & Lubotsky work hidden away in the psychology literature.

In a 1967 paper Xhignesse and Osgood discuss "Bibliographic Citation Characteristics of the Psychological Journal Network in 1950 and in 1960" and introduce the terminology of information networking to the citation field.¹⁵ They mention that "...journals are a part of the formal channel of scientific communication as well as storage elements for the summary accounts of research undertakings".¹⁶ They specifically present their data in terms of the number of information network parameters, including traffic, congruence, feeding/storing, self-feeding, source and destination balances, filter/condensor ratios, network organization, etc. A further original part of Xhignesse & Osgood's paper lies in its graphic portrayal of the distances between journals in terms of their reciprocal citations. They used an interpoint distance procedure, starting with the assumption of no structure (equal distance between all journal points) and making iterative adjustments in distances to match the actual rank order of citation frequencies for each journal in relation to other journals. This seems to be the first time that the concept of "distance" between journals was introduced.

¹²M.M. Kessler, "Bibliographic Coupling Between Scientific Papers," American Documentation (January 1963):10-25.

¹³M.M. Kessler, "Some Statistical Properties of Citations in the Literature of Physics," Statistical Association Methods in Mechanized Documentation (Symposium Proceedings, 1964), Washington: National Bureau of Standards Miscellaneous Publication 269, 1965.

¹⁴Ibid., p. 193.

¹⁵Louis V. Xhignesse and Charles E. Osgood, "Bibliographic Citation Characteristics of the Psychological Journal Network in 1950 and in 1960," American Psychologist 22 (1967): 778-791.

¹⁶Ibid., p. 778.

TABLE 3-1

PAIRS OF PAPERS MOST STRONGLY COUPLED
(from Kessler, 1963)

Electron-Neutrino Angular Correlation in the Beta Decay of Neon 19.....	D. R. Maxson, J. S. Allen, and W. K. Jentschke
Gamow-Teller Interaction in the Decay of He ⁶	B. M. Rustad and S. L. Ruby
Internal and External Bremsstrahlung Accompanying the Beta Rays of P ³²	K. Liden and N. Starfelt
Internal and External Bremsstrahlung in Connection with the Beta Decay of S ³⁵	N. Starfelt and N. L. Svantesson
Photoproduction of π^0 Mesons from Protons.....	Y. Goldschmidt-Clermont, L. S. Osborne, and M. Scott
Photoproduction of Neutral Pions in Hydrogen: Magnetic Analysis of Recoil Protons.....	D. C. Oakley and R. L. Walker
Theory of Polarization of Nucleons Scattered Elastically by Nuclei.....	Sidney Fernbach, Warren Heckrotte and Joseph Lepore
Polarization in Scattering by Complex Nuclei.....	S. Tamor
Polarization in Scattering by Complex Nuclei.....	S. Tamor
Polarization of Nucleons Elastically Scattered from Nuclei.....	R. M. Sternheimer
Gamma and X-Radiation in the Decay of Am ²⁴¹	H. Jaffe, T. O. Passell, C. I. Browne, and I. Perlman
Electromagnetic Spectrum of Am ²⁴¹	Paul P. Day
Coulomb Excitation of Neodymium.....	B. E. Simmons, D. M. Van Patter, K. F. Famularo, and R. V. Stuart
Electric Excitation of Heavy Nuclei by Protons.....	Clyde McClelland, Hans Mark, and Clark Goodman
Dynamics of Simple Lattices.....	Herbert B. Rosenstock
Vibration Spectra and Specific Heats of Cubic Metals. I. Theory and Application to Sodium.....	A. B. Bhatia
Motions of Electrons and Holes in Perturbed Fields.....	J. M. Luttinger and W. Kohn
Theory of the Infrared Absorption of Carriers in Germanium and Silicon.....	A. H. Kahn
Theory of Polarization of Nucleons Scattered Elastically by Nuclei.....	Sidney Fernbach, Warren Heckrotte and J. Lepore
Polarization of Nucleons Elastically Scattered from Nuclei.....	R. M. Sternheimer
Domain Rotation in Nickel Ferrite.....	Fielding Brown and Charles L. Gravel
Magnetic Rotation Phenomena in a Polycrystalline Ferrite.....	David Park
Temperature Dependence of Electron Mobility in AgCl.....	Frederick C. Brown
Mobility of Electrons and Holes in the Polar Crystal, PbS.....	Richard L. Petritz and Wayne W. Scaulon
Quantum Theory of Many-Particle Systems. I. Physical Interpretations by Means of Density Matrices, Natural Spin-Orbitals, and Convergence Problems in the Method of Configurational Interaction.....	Per-Olov Lowdin
Quantum Theory of Many-Particle Systems. II. Study of the Ordinary Hartree-Fock Approximation.....	Per-Olov Lowdin
Quantum Theory of Many-Particle Systems. I. Physical Interpretations by Means of Density Matrices, Natural Spin-Orbitals, and Convergence Problems in the Method of Configurational Interaction.....	Per-Olov Lowdin
Quantum Theory of Many-Particle Systems. III. Extension of the Hartree-Fock Scheme to Include Degenerate Systems and Correlation Effects.....	Per-Olov Lowdin

Current activity on the journal structure of the scientific literature has been significantly influenced by the availability of large amounts of data from the Science Citation Index, and the related work of Garfield and his colleagues at the Institute for Scientific Information (ISI).

In an extensive paper in 1972 Garfield discusses citation analysis as a tool in journal evaluation with explicit recognition of the policy implication of this through his subtitle of the paper: "Journals Can be Ranked by Frequency and Impact of Citations for Science Policy Studies".¹⁷

The Garfield paper is a milestone in the field. There are more data covering more citations to more journals in that one paper than there had been in all the scientific literature up to that time. The journal rankings were based on all references in articles abstracted by the SCI during the last quarter of 1969, in the 2,200 journals then covered. The resulting sample was about 1,000,000 citations to journals, books, reports, theses, and so forth.

In the paper Garfield shows some interesting statistics on the unification of variants in cited journal names, a problem that was first noted by Cason & Lubotsky in 1936. Garfield points out that there were "...more than 100,000 different abbreviations for the 12,000 individual journal titles cited in the 3 month sample".¹⁸

Garfield mentions many of the other problems of dealing with large data bases--journals merge, they split into new journals, they change titles, they appear in one or more translations, they change their numbering, they issue supplements, and so forth. Both Computer Horizons and ISI have various thesaurus tapes with equivalents of tens of thousands of variants of the journal names.

In his discussion Garfield starts in the library scientist's role, remarking that "a good multidisciplinary journal collection need contain no more than a few hundred titles".¹⁹ He also points out that 24% of the citations are to the 25 most frequently cited journals, and that fully half of the citations are to only 152 journals. He further notes that the average cited paper is cited only 1.7 times a year.

In one table in the article Garfield shows the 152 most frequently cited journals, and includes his journal impact factor, which is obtained by dividing the number of 1969 references to 1967 and 1968 articles, by the number of articles published in 1967 and 1968.

¹⁷Eugene Garfield, "Citation Analysis as a Tool in Journal Evaluation," Science 178 (1972):471-479.

¹⁸Ibid., p. 473.

¹⁹Ibid., p. 474.

Table 3-2 shows the six journals (among the 100 most frequently cited journals) with impact factors greater than five. The table reveals a fundamental point about this kind of analysis: The data are very field-dependent. That is, five out of six of those journals are in the biomedical field, as are the great majority of the rest of the large journals which have impact factors between 4 and 5.

Another table in Garfield's paper shows the 152 journals which have the highest impact factors. Table 3-3 shows the first 20 of these. The presence of a substantial number of review journals in that list reveals another characteristic of the impact factor as used by Garfield: the impact factor is relatively sensitive to the form of publication, since most review papers are long, contain many references, and are cited quite heavily; however, they are not necessarily very different in citations per page when allowances are made for the length of the paper.

Both the field-to-field differences and the problems of the size and length of paper are explicitly considered in the influence methodology developed in Chapter VII, which rigorously formulates a series of influence measures for all of the substantial journals in the SCI.

Garfield's 1972 paper was largely bibliometric in orientation, although it did recognize the policy potential of the data. The subsequent work of H. Small at ISI is more evaluative in nature, mapping the structure of clusters of papers representing scientific specialties.

In two papers appearing in 1973 and 1974,^{20,21} H. Small described a new form of document coupling called co-citation which links cited documents: co-citation frequency is defined as "...the frequency with which two items of earlier literature are cited together by the later literature".²² Figure 3-3 contrasts the difference between co-citation and the predecessor bibliographic coupling. Note that co-citation is a dynamic measure: as subsequent scientists cite their predecessor works, the strengths of the links will change, always reflecting the association between papers as seen from the frontier of current science.

²⁰Henry Small and Belver C. Griffith, The Structure of Scientific Literatures I: Identifying and Graphing Specialties (Philadelphia, Pa.: Drexel University, 1975).

²¹Henry Small, "Co-citation in the Scientific Literature: A New Measure of the Relationship Between Two Documents," Journal of the American Society for Information Science 24 (1973): 265-269.

²²Ibid., p. 265.

TABLE 3-2*

SIX LARGE JOURNALS WITH IMPACT FACTORS GREATER THAN FIVE
(adapted from Garfield, 1972)

Cited Journal	Times Cited Last Quarter 1969	1969 Citations to 1967 & 1968 Articles	Articles Published in 1967 & 1968	Impact Factor
J AM CHEM SOC	26,323	22,156	3,946	5.614
J BIOL CHEM	17,112	10,768	1,777	6.059
P NAS US	8,260	11,548	1,348	8.566
J MOL BIOL	4,982	7,340	833	8.811
BIOCHEMISTRY	4,076	6,344	1,114	5.694
J EXP MED	3,871	2,700	325	8.307

*For full titles of journal titles abbreviated,
please see Appendix II.

TABLE 3-3*

TWENTY JOURNALS WITH HIGHEST IMPACT FACTORS
(adapted from Garfield, 1972)

CITED JOURNAL	TIMES CITED LAST QUARTER 1969	1969 CITATIONS TO 1967 & 1968 ARTICLES	ARTICLES PUBLISHED IN 1967 & 1968	IMPACT FACTOR
ADV PROTEIN CHEM	373	184	8	23.000
PHARMACOL REV	725	448	20	22.400
BACTERIOL REV	646	804	39	20.615
ANN REV BIOCHEM	468	932	53	17.584
PHYSIOL REV	1022	572	33	17.333
ACCOUNTS CHEM RES	247	820	48	17.083
SOLID STATE PHYS	384	228	14	16.285
ADV ENZ MOL	291	192	20	9.600
INT REV CYTOL	230	144	16	9.000
J MOL BIOL	4982	7340	833	8.811
REC PROG HORMONE RES	417	232	27	8.592
P NAS US	8260	11548	1348	8.566
J EXP MED	3871	2700	325	8.307
Q REV	488	452	55	8.218
CHEM REV	1003	408	50	8.160
ANN REV PL PHYSIOL	314	296	42	7.047
J CRYST GROWTH	232	820	125	6.560
ANN REV MICROBIOL	254	288	44	6.545
J BIOL CHEM	17112	10768	1777	6.059
METHODS BIOCHEM ANAL	285	80	14	5.714

*For full titles of journal titles abbreviated,
please see Appendix II.

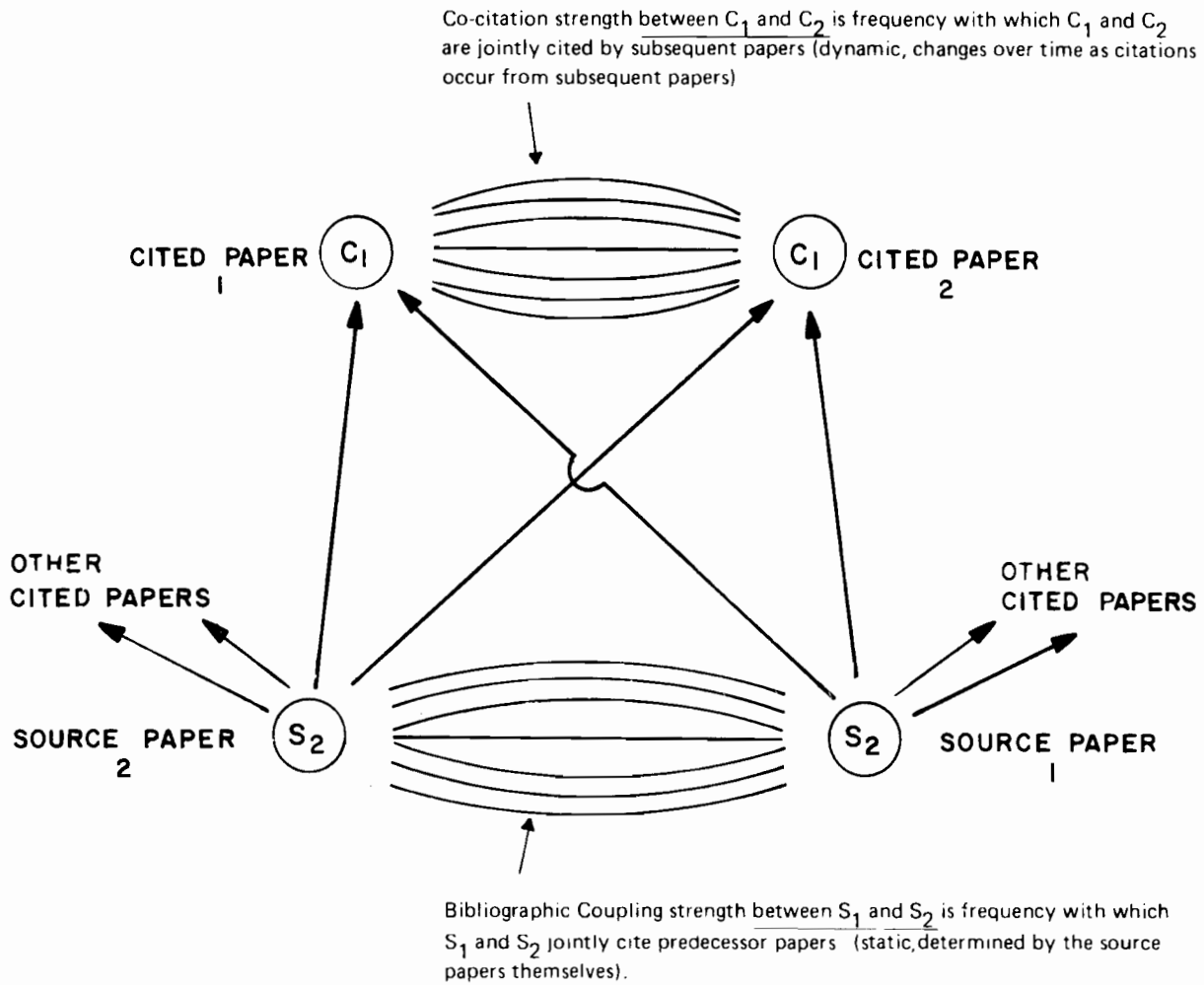

FIGURE 3-3

BIBLIOGRAPHIC COUPLING AND CO-CITATION STRENGTH

Small's motivation seems to be evaluative rather than bibliometric; he is interested in locating networks of frequently cited papers and in using these networks to define scientific specialties and the nature of activities at the research front. Figure 3-4, taken from the first of Small's papers, shows the co-citation network for frequently cited papers in particle physics. In the second paper, by Small and Griffith, keywords are used to show that many of the co-cited papers are indeed quite close to one another in subject interest.

At the same time Garfield was publishing his paper on impact factors, and Small and Griffith were considering the micro-scale structure of the literature, Computer Horizons began to classify journals on a macro-level by fields and sub-fields. In 1972 Computer Horizons published a paper which mapped the interrelationships between individual journals and fields.²³ Specifically, Computer Horizons developed the two-step map for chemistry journals shown in Figure 3-5, and the hierarchy for the same chemistry journals reproduced in Figure 3-6. In the two-step map, two arrows are drawn from each journal to the journals (other than itself) which it cites first and second most frequently. In the two-step map for chemistry, the Journal of the American Chemical Society is obviously the central journal in chemistry. The important roles of the Journal of Chemical Physics, Analytical Chemistry and the British Journal of the Chemical Society (ABC) are also apparent. In addition, the two-step map is a graphic example of the high degree of orderliness of the scientific literature. The map also adds a substantial amount of prima facie validity to a journal classification scheme. Virtually every journal on the two-step chemistry map cites first or second most frequently to another journal on that map, a strong indication that those are chemical journals that belong on a map of chemistry. Interestingly enough, one of the journals that cites out of chemistry, the Journal of Chemical Physics, provides a link to physics through the Physical Review, and is by its own design a journal which links chemistry and physics and is central to the field of chemical physics, an intermediate field between chemistry and physics.

The next figure, the hierarchy of chemistry journals, reveals another aspect of the structure of the journal literature: a very strong and very well-ordered hierarchic relationship which seems to exist between journals. On the hierarchy, a journal A is placed above a journal B, if A refers to B a larger percentage of the time than B refers to A. The entire

²³ Francis Narin, Mark P. Carpenter, and Nancy C. Berlt, "Interrelationships of Scientific Journals," Journal of the American Society for Information Science 23 (1972):323-331.

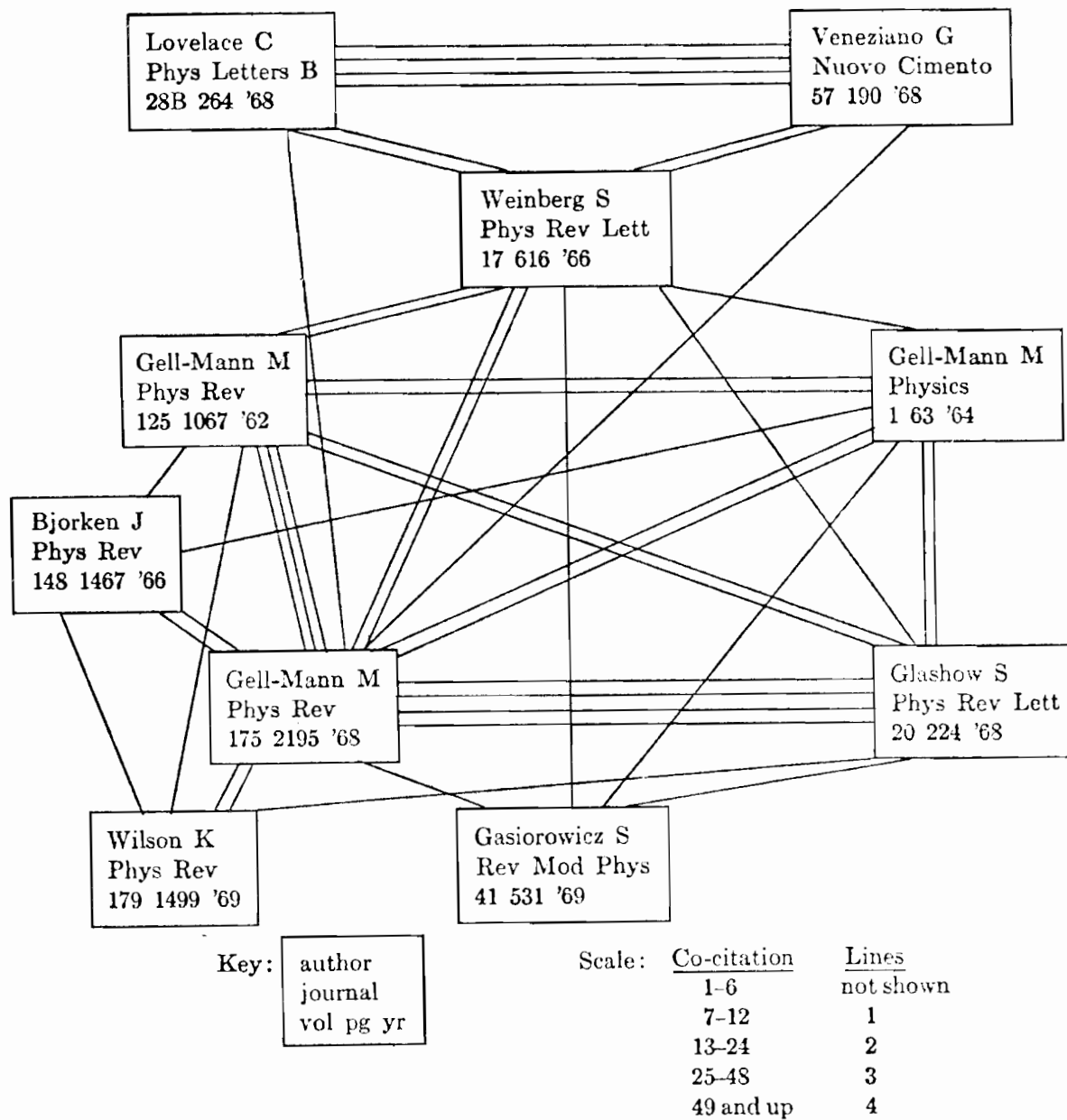

FIGURE 3-4

CO-CITATION NETWORK FOR FREQUENTLY CITED
PAPERS IN PARTICLE PHYSICS
(from Small, 1973)

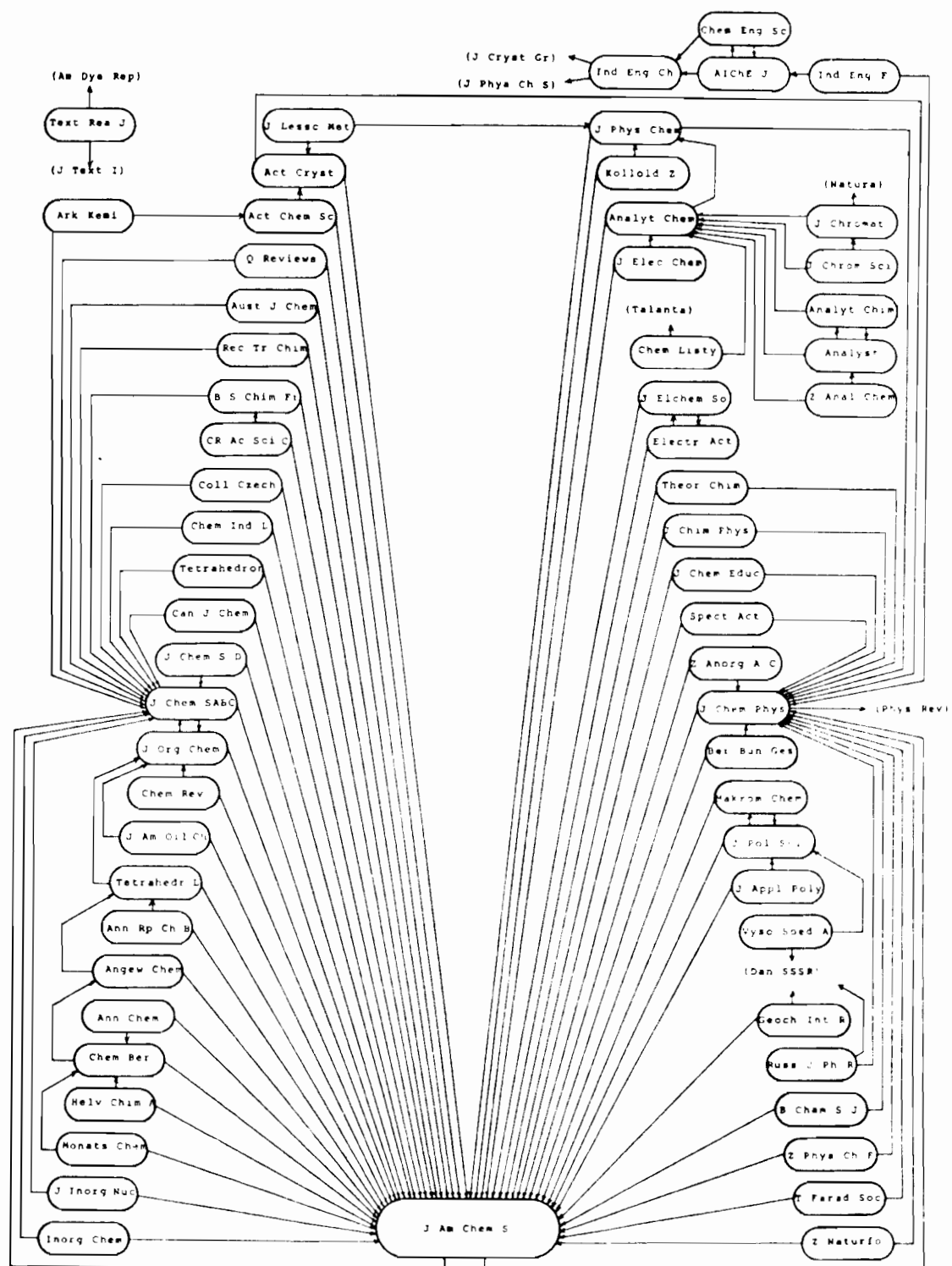

FIGURE 3-5

TWO-STEP MODEL FOR 62 CHEMISTRY JOURNALS IN 1969
 (from Narin, Carpenter & Berlt, 1972)

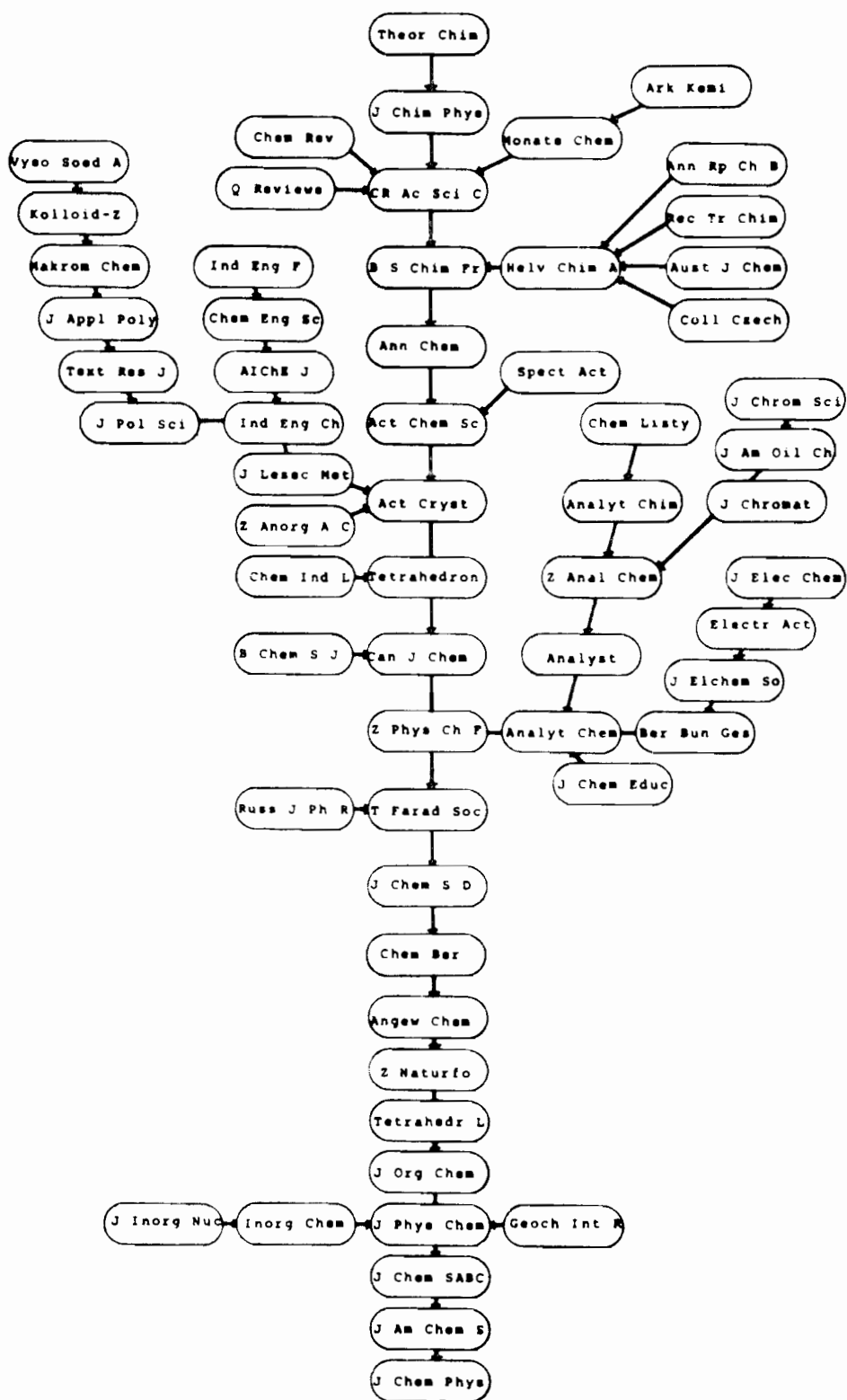

FIGURE 3-6

HIERARCHY FOR 62 CHEMISTRY JOURNALS IN 1969
 (from Narin, Carpenter & Berlt, 1972)

hierarchy is transitive and anti-symmetric. Each journal in the hierarchy refers to every journal below it a larger percentage of the time than any journal below refers to a higher journal, with very few exceptions. For example, on the chemistry hierarchy there are 399 pairs of journals for which one refers to the other more than 1% of the time; only 7 of these relationships, or 1.8%, are in conflict with the structure shown on the hierarchy. Thus there seems to be a clear, strong hierarchic relationship among journals.

Both the two-step and the hierarchic models, while graphically revealing certain properties of the literature, contain a hidden weakness in that they do not explicitly compensate for the size of the journals. The journals at the bottom of the maps are not only heavily cited, but are also large. These two factors are not separated in either of the mapping techniques.

It should be noted that there is a definite tendency for the larger journals to be cited out of proportion to their size, as any consideration of the number of citations per article or citations per reference reveals. For example, the Journal of the American Chemical Society, which is by far the largest journal in chemistry, is an outstanding journal by any definition of impact or influence. Nevertheless, the clear and systematic separation of size effects was not done until the Computer Horizons work reported in Chapter VII.

In that same 1972 paper, Computer Horizons extended the mapping technique and developed one of the first maps of cross-field citing, the two-step cross-field map shown in Figure 3-7. In this figure, the fields themselves are designated by rectangles, and individual journals as ovals. If all first or second citations to a journal are from journals within a field, then that journal is placed within the field--thus the great majority of the chemistry journals are represented by the box labeled "chemistry" in Figure 3-7. The only journals shown individually are journals which cite or are cited first or second most frequently by journals in different fields. As a result, journals which perform linking roles, such as the Journal of Chemical Physics, graphically portray their behavior. A group of journals seems to link the core of biochemistry with biology, including the Journal of Biological Chemistry which is the largest and most influential of all the biomedical journals: although JBC itself is the heart of biological chemistry, it also functions in a linking role. The journals Science and Nature are first and second most frequently cited by many biological journals, as well as by many journals in other fields. This is due more to their multi-disciplinary nature than to a linking of knowledge between different fields. Nevertheless, these are outstanding journals, with a remarkably broad role. The hierarchic nature of the literature of physics, and some of the other characteristics of highly cited physics journals

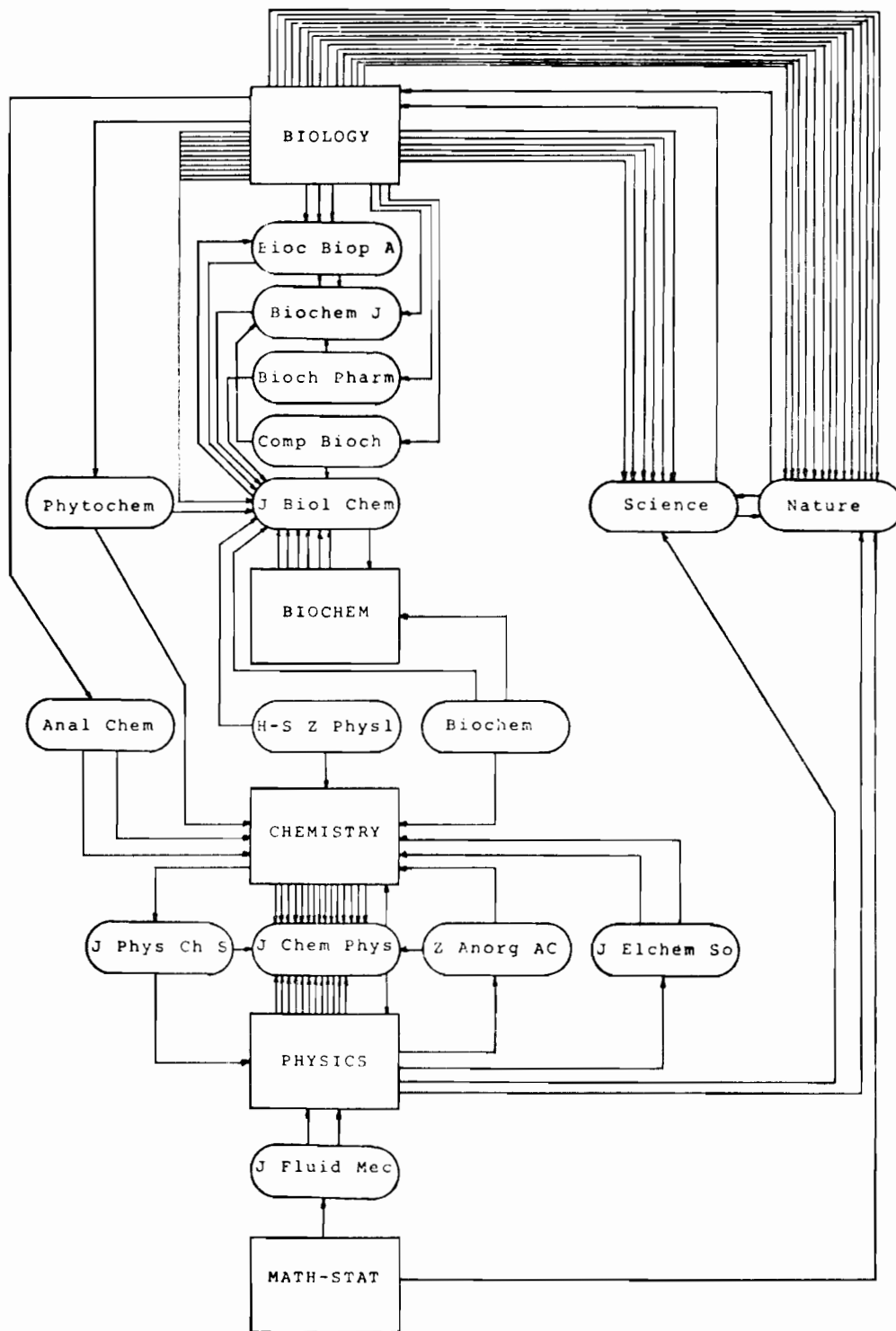

FIGURE 3-7

TWO-STEP CROSS-FIELD MODEL - 1969
 (from Narin, Carpenter & Berlt, 1972)

are discussed further in a 1974 article by Inhaber,²⁴ which builds upon Computer Horizons work²⁵ and the work of Garfield.²⁶

As an attempt at a further refinement in journals classification, in 1973 Computer Horizons developed a procedure for clustering scientific journals based on their cross-citation patterns.²⁷ In that paper 288 journals in the disciplines of physics, chemistry, and molecular biology were grouped into clusters, most of which were easily identified. Table 3-4 shows the clusters which resulted from the cross-referencing in a set of 81 physics journals. Among the physics clusters there is one very large cluster of general physics journals, dominated by the Physical Review. This cluster also encompasses the subfield of nuclear physics, largely because many papers in the field of nuclear physics are published in the Physical Review itself. While most of the clusters are easily labeled, as shown in the table, they are not all based on subject. Clusters characterized by nationality can be formed, as seen by the relatively strong Soviet physics group, and a second group whose major characteristic is its Germanic origin.

A very promising multi-dimensional scaling approach to measuring the relationships among scientific journals is now being developed by Hamelman and his colleagues at Virginia Polytechnic Institute. They have been extensively studying the citation patterns within the business literature, and have applied the techniques of Shepard^{28,29} and Kruskal³⁰ to determine the con-

²⁴Herbert Inhaber, "Is There a Pecking Order in Physics Journals?," Physics Today (May 1974):39-44.

²⁵Narin, Carpenter, and Berlt, "Interrelationships of Scientific Journals."

²⁶Garfield, "Citation Analysis As A Tool in Journal Evaluation."

²⁷Mark P. Carpenter and Francis Narin, "Clustering of Scientific Journals," Journal of the American Society for Information Science 24 (November-December 1973):425-436.

²⁸R.N. Shepard, "The Analysis of Proximities: Multi-dimensional Scaling With An Unknown Distance Function, Part One," Psychometrika 27 (June 1962):125-140.

²⁹R.N. Shepard, "The Analysis of Proximities: Multi-dimensional Scaling With An Unknown Distance Function, Part Two," Psychometrika 27 (September 1962):219-246.

³⁰J.B. Kruskal, "Nonmetric Multi-dimensional Scaling: A Numerical Method," Psychometrika 29 (June 1964):115-129.

TABLE 3-4 *

CLUSTERS FOR A SET OF 81 PHYSICS JOURNALS
(from Narin & Carpenter, 1973)

Acoustics	Phys Rev L	Astronom J
Acustica	Physica	Astrophys J
J Acoust So	Prog T Phys	Aust J Phys
J Sound Vib	Rep Pr Phys	B CSAR Belg
Sov Ph Ac R	Rev M Phys	Icarus
	Z Phys	J Atmos Sci
Minerals		P Roy Soc A
Am J Sci	German Physics	Sov Astro R
Am Mineral	Ann Physik	
Mineral Mag	Z Ang Phys	Soviet Physics
	Z Naturfo A	DAN USSR
Geophysics and Space	Optics	JETP Letter
Ann Geophys	Appl Optics	Opt Spect R
J Atm Ter P	J Opt Soc	Sov J Nuc R
J Geoph Res		Sov Ph JE R
Naturwissen	Solid State and Applied Physics	Sov Ph SS R
Planet Spac	Adv Physics	Sov Ph TP R
Pur A Geoph	Appl Phys L	Sov Ph US R
Rev Geophys	Czec J Phys	
Spac Sci R	I J P A Phys	General Physics
	J Appl Phys	J Phys ABC
General and Nuclear Physics	J Phys Ch S	J Phys D
Am J Phys	Jap J A Phy	J Phys Jap
Ann Physics	Philos Mag	
Ann R Nucl	Phys Fluids	Fluid
Ark Fysik	Phys Kond M	Mechanics
Can J Phys	Phys St Sol	J Fluid Mec
CR Ac Sci B		Phi T Roy A
Helv Phys A	Geology	Q J R Meteo
J Math Phys	Arctic	
J Physique	Geoch Cos A	Unclustered Journals
Nucl Phys	Geol S Am B	J Res NBS A
Nuov Cim		Nucl Fusion
Phys Lett	Astronomy and Astrophysics	Rev Ro Phys
Phys Rev	Astron Astr	Rev Sci Ins
		Z Ang Geol

* For full titles of journal titles abbreviated,
please see Appendix II.

figuration of a set of journals. Figure 3-8 from the paper of Cox, Hamelman and Wilcox³¹ shows how well this technique can summarize journal relationships.

Thus, over a period of fifty years, interest in the relationships among publications and journals has grown far beyond the domain of the librarian, into graphic and analytical studies of the manner in which scientific papers, journals, subfields, and fields interact with and influence one another.

³¹Eli Cox III, Paul W. Hamelman, and James B. Wilcox, "Relational Characteristics of the Business Literature: An Interpretive Procedure," The Journal of Business 49 (April 1976).

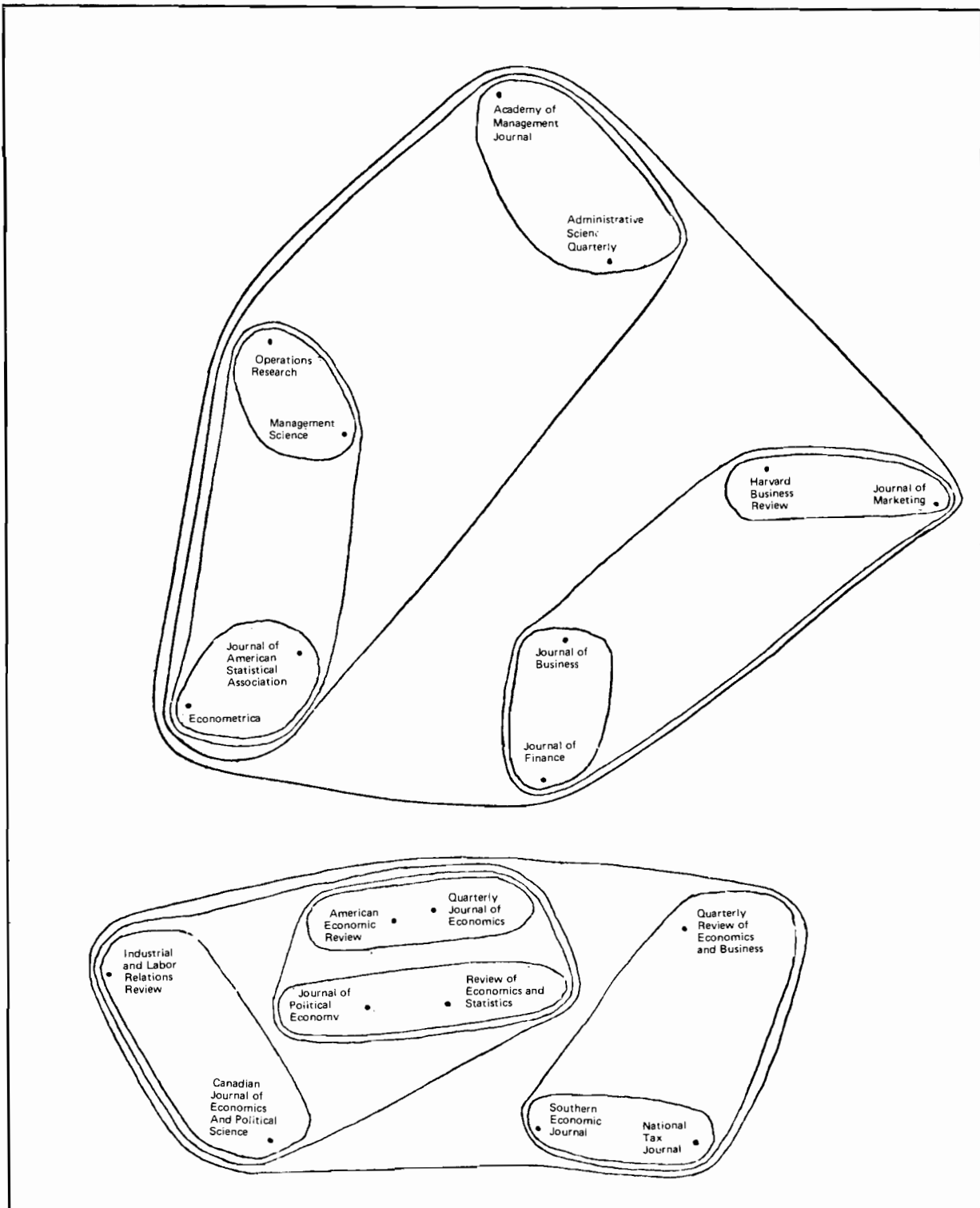

FIGURE 3-8

HIERARCHICAL CLUSTERING OF THE CONFIGURATION OF
 BUSINESS AND ECONOMICS JOURNALS
 (from Cox, Hamelman & Wilcox, 1976)

IV. SCIENTIFIC PRODUCTIVITY

In his book Little Science, Big Science Derek Price reviews the early interest in measuring the distribution of quality or eminence among scientists. Price starts with a discussion of the work of Francis Galton,¹ who was concerned with estimating the rarity of various outstanding men, particularly those in science. Galton used a variety of informal literary criteria for measuring eminence, such as inclusion in biographical compilations, or in select columns of obituary notices. Later studies by others were based on inclusion in American Men of Science, which places stars by especially noteworthy names.

All of these early works concluded that eminence is very highly concentrated within a population. Figure 4-1 traces the important papers which have dealt with this phenomenon from a bibliometric viewpoint.

The high concentration of productivity was crystallized for bibliometrics by A.J. Lotka, of the Metropolitan Life Insurance Company, in 1926, as an inverse square law of productivity.² In his landmark paper Lotka states that "...it would be of interest to determine, if possible, the part which men of different calibre contribute to the progress of science."³ Lotka used entries from the Decennial Index of Chemical Abstracts, 1907-1916 against which appeared 1,2,3... entries, covering the letters A and B of the alphabet both separately and together. He also covered the same part of the name index of Auerbach's Geschichtstafeln der Physik which covers the entire range of history up to and including 1900. He points out that Auerbach's list gives

...a measure not merely of volume of productivity, but account is taken in some degree, also of quality, since only the outstanding contributions find a place in this volume, with its 110 pages of tabular text.⁴

The result of Lotka's investigation is an inverse square law of productivity by which the number of people producing N papers is

¹Derek J. de Solla Price, Little Science, Big Science, (New Haven: Yale University Press, 1963), 33-61.

²Alfred J. Lotka, "The Frequency Distribution of Scientific Productivity," Journal of the Washington Academy of Science 16 (June, 1926):317-323.

³Ibid., p. 317.

⁴Ibid., p. 317.



FIGURE 4-1

IMPORTANT PAPERS ON SCIENTIFIC PRODUCTIVITY

proportional to $1/N^2$. This says that for every 100 authors who produce 1 paper in a given period of time there are $100/2^2$ or 25 who produce 2, $100/3^2$ or 11 who produce 3 and so on. Figure 4-2, from Lotka's paper, illustrates this point.

For almost thirty years following the work of Lotka, substantial interest in bibliometric productivity seems lacking. However, in 1954 W. Dennis looked at bibliographies of eminent scientists,⁵ and H.D. Lehman published a series of papers and a book discussing scientific creativity, and the ages at which it peaks for scientists in different fields and different countries.⁶ Lehman obtains his data by counting the "contributions" of scientists at a given age, where "contribution" refers to a description of a scientific achievement in a bibliographic source for a given field. As a result he is counting a conglomerate of papers, books and other events. His general conclusion is that the creative production rate peaks for scientists in most fields at ages 30 to 34, although for physics it seems to peak in the 25 to 29 age range. Figure 4-3, taken from a 1962 paper of Lehman's, summarizes his contention.⁷

While Lehman shows that the maximum of creative productivity seems to occur before age 39, this is not to be interpreted as meaning that there is any sharp maximum in general productivity. Lehman's counts were obtained from various bibliographies and tabulations of important, landmark discoveries in each field. A different picture of much more stable rates of productivity emerges if consideration is given to overall productivity rates: the number of papers a typical working scientist produces each year. Two studies, a 1954 study by W. Dennis⁸ and a 1965 study by B.T. Eiduson⁹ both seem to indicate that research productivity is maintained at a generally stable level until about age 60. Dennis showed that the pro-

⁵Wayne Dennis, "Bibliographies of Eminent Scientists," The Scientific Monthly (September 1954):180-184.

⁶Harvey C. Lehman, "The Chemist's Most Creative Years," Science 127 (May 1958):1213-1222.

⁷Harvey C. Lehman, "The Creative Production Rates of Present Versus Past Generations of Scientists," Journal of Gerontology 17 (1962):411.

⁸Wayne Dennis, "Predicting Scientific Productivity in Later Maturity from Records of Earlier Decades," Journal of Gerontology 9 (1954):465-467.

⁹Bernice T. Eiduson, "Productivity Rate in Research Scientists," American Scientist 54 (1966):57-63.

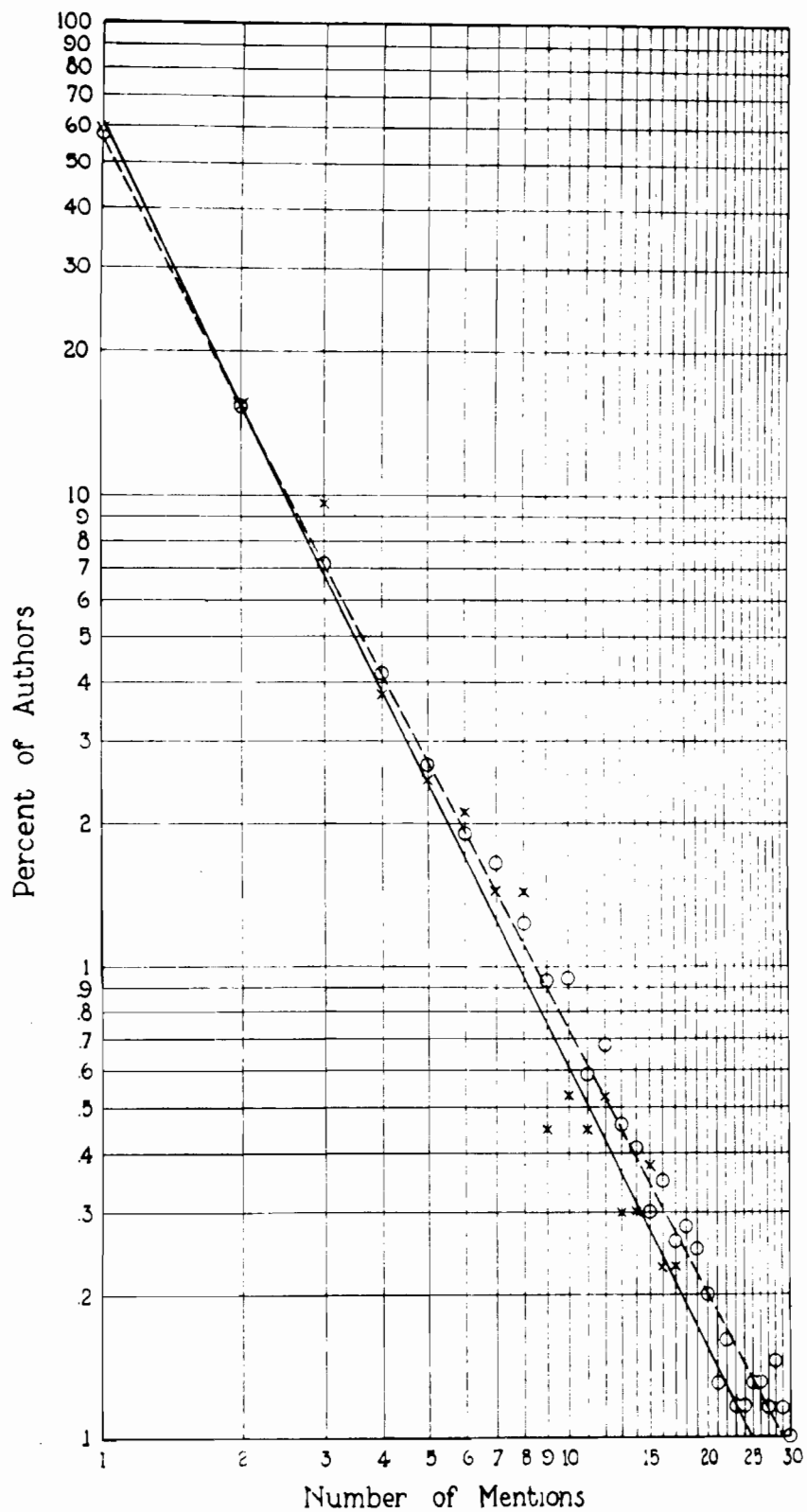

Logarithmic frequency diagram showing number of authors mentioned once, twice, etc., in Auerbach's tables (points indicated by crosses), and in Chemical Abstracts, letters A and B (points indicated by circles).

FIGURE 4-2

PUBLICATION FREQUENCY FOR AUTHORS
(from Lotka, 1926)

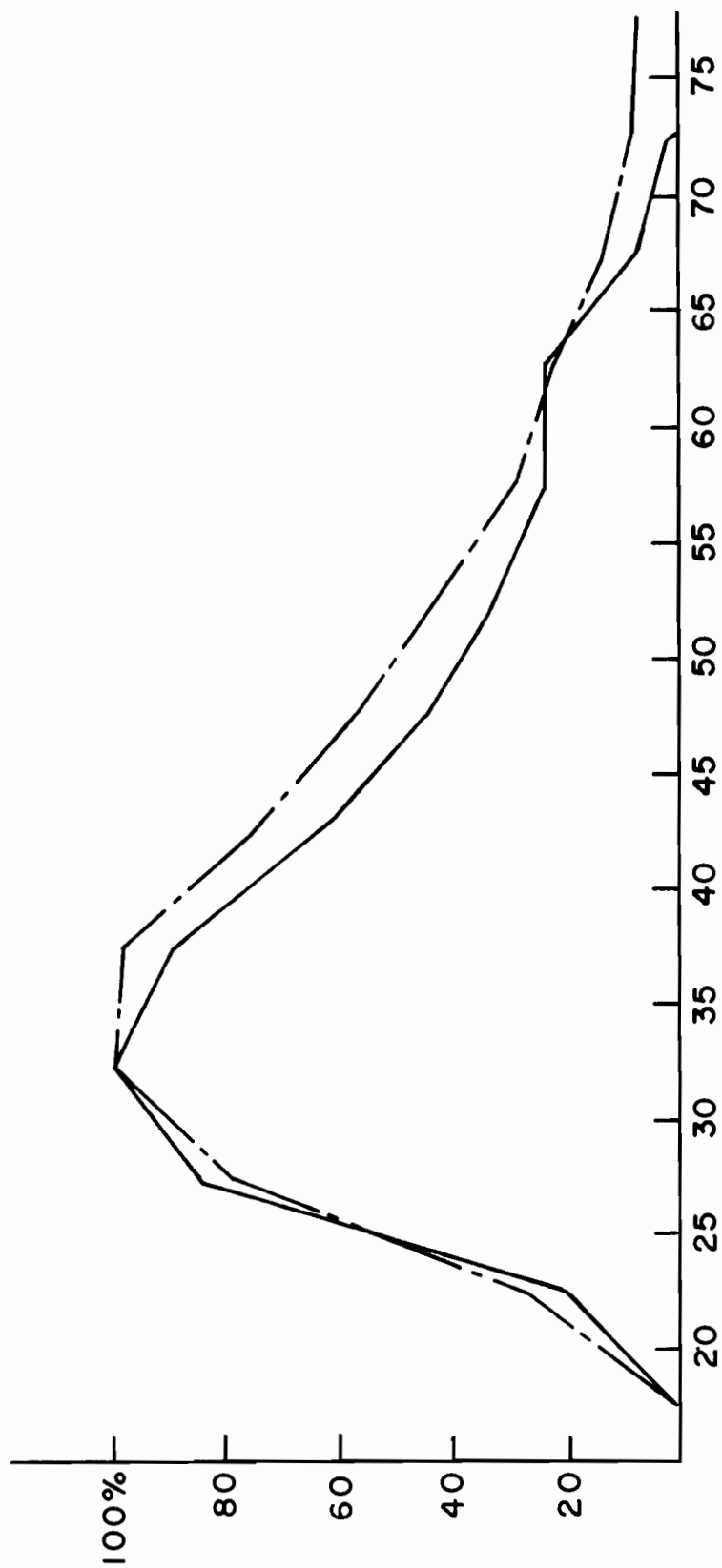

CHRONOLOGICAL AGES

Age versus contributions to chemistry. Solid line, median values obtained from 11 statistical distributions (percentage values) of age data for "still-living" contributors. Broken line, comparable age data for 11 deceased groups born subsequent to 1774.

FIGURE 4-3

AGE VERSUS CONTRIBUTIONS TO CHEMISTRY
(from Lehman, 1962)

ductivity rate was so consistent that the number of publications that scientists produced during their 40's and 50's could be reasonably well predicted from the number of publications produced in their 30's. Eiduson went farther and looked at the same phenomenon, differentiating between production rates for scientists who stayed in research and scientists who switched to administrative or industrial activities. Her general conclusion was that, for the research scientists who remained in research, productivity rose slightly in their 40's and 50's, although the reverse was clearly true for scientists who began to devote significant time to administration. In the next chapter data will be presented from a few other studies which also seem to indicate a relatively level rate of publication for an active research scientist over two or three decades of his professional career.

In 1957 W. Shockley, the co-winner of the 1956 Nobel Prize in physics, considered scientific productivity from an institutional viewpoint, analyzing the statistics of individual productivity in research laboratories.¹⁰ His overall conclusion is that "...in any large and reasonably homogeneous laboratory...there are great variations of the output of publication between one individual and another."¹¹ After considering the distributions he further concludes

...the more or less normal distribution of the logarithm of the rate of publication is characteristic of the statistics of the scientific creative process. Perhaps the most important feature of this conclusion is that the rate of publication increases approximately exponentially from individual to individual, taken in order of increasing rate, and that the differences in rates between low and high producers are very large.¹²

This is, of course, very similar to the conclusion of Lotka, whose work Shockley did not seem to know. Figure 4-4, taken from Shockley's paper, shows that the publication productivity of the Brookhaven National Laboratory staff is essentially log normal over a wide range. Shockley shows similar distributions for scientists at other laboratories and at a few universities.

¹⁰William Shockley "On the Statistics of Individual Variations of Productivity in Research Laboratories," Proceedings of the IRE, (March 1957):279-290.

¹¹Ibid., p. 280.

¹²Ibid., p. 281.

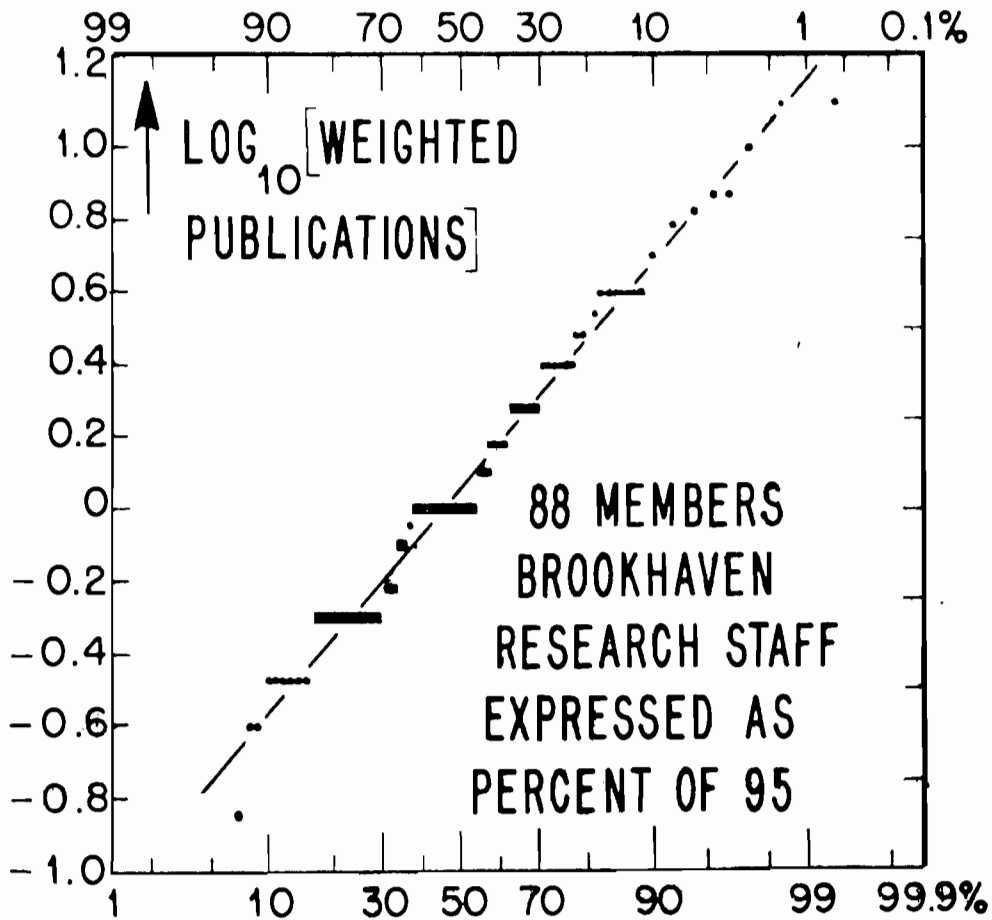

Cumulative distribution of logarithm of "weighted" rate of publication at Brookhaven National Laboratory plotted on probability paper.

FIGURE 4-4

COMPARATIVE DISTRIBUTION OF LOGARITHM OF
"WEIGHTED" RATE OF PUBLICATION
(from Shockley, 1957)

Shockley then presents some fascinating speculation on the reason for such exponential characteristics of productivity. He suggests that one reason for this might be that there is some attribute of the human brain that allows an individual to be simultaneously aware of some number m of ideas and their relationships. The number of ideas an individual can create is dependent on the permutations and combinations of m , which increase very rapidly with increasing m .

He also proposes a different way of rationalizing the productivity difference, by suggesting that the factors involved in publishing a scientific paper may be multiplicative. "A partial listing, not in order of importance, might be

1. Ability to think of a good problem
2. Ability to work on it
3. Ability to recognize the worthwhile result
4. Ability to make a decision as when to stop and write up the results
5. Ability to write adequately
6. Ability to profit constructively from criticism
7. Determination to submit the paper to a journal
8. Persistence in making changes (if necessary as a result of journal action).

To some approximation, the probability that a worker will produce a paper in a given period of time will be a product of a set of factors F_1, F_2 , etc., related to the personal attributes discussed above. The productivity of the individual would then be given by a formula such as $P = F_1F_2F_3F_4F_5F_6F_7F_8$. Now if one man exceeds another by 50% in each of the eight factors, his productivity would be larger by a factor of 25. On the basis of this reasoning we see that relatively small variations in specific attributes can produce the large variation in productivity. ... (Furthermore), according to the formula, the logarithm of the product is the sum of the logarithms of the several factors. If we suppose that these factors vary independently, then to a good approximation their sum will have a normal distribution, and so, consequently, will the logarithm of their productivity."¹³

There does not seem to be any further work built upon or attempting to prove or disprove Shockley's speculations.

¹³Ibid., p. 286.

At about the same time as Shockley, Lehman, and the others were systematically studying publication counts as measures of productivity, the idea of using citation counts for this purpose also began to appear.

In 1955, E. Garfield discussed the possibility of constructing a citation index for science analogous to the legal research tool, Shepard's Citations.¹⁴ In his paper he states that

In effect, the system would provide a complete listing, for the publications covered, of all the original articles that had referred to the article in question. This would clearly be particularly useful in historical research when one is trying to evaluate the significance of a particular work and its impact on the literature and thinking of the period. Such an "impact factor" may be much more indicative than an absolute count of the number of a scientist's publications, which was used by Lehman and Dennis.¹⁵

Some five years after Garfield made his suggestion of using citations to measure the impact of individual papers, J.H. Westbrook suggested the use of citation counts at the institutional level, and published the first citation counts of this type.¹⁶

Westbrook's 1960 paper was aimed at the laboratory rather than the individual and deals with publication counts, citation counts, and citations/publication for universities, private and government laboratories active in ceramics. He points out that while a publication count is a measure of scientific activity, it gives little indication of the quality or significance of the work. He asks

...how, then, does one distinguish, on an objective basis, the brilliant research paper from the marginally acceptable, the trivial from the significant piece of work.¹⁷

¹⁴Eugene Garfield, "Citation Indexes for Science," Science 122 (July 15, 1955):108-111.

¹⁵Ibid., p. 109.

¹⁶J.H. Westbrook, "Identifying Significant Research," Science (October 1960):1229-1234.

¹⁷Ibid., p. 1229.

Sampling from two sources of papers, Westbrook tabulates the number of references to various specific laboratories, which are identified by the affiliation of the author at the time the work was done. His citation data were based on two populations (A and B): the references in 99 papers published in the 1958 Journal of the American Ceramic Society, and the references from a composite group of papers on ceramics published in a representative group of journals which cite into the area of ceramics. Publication counts were counts of the papers in A and B, attributed to institutions by the author's affiliations. Figure 4-5 shows the correlations between the number of citations and number of publications, including Westbrook's classification of different types of institutions. In computing net citations Westbrook eliminates in-house citations, and also self-citations by an author to his own work at a previous laboratory. One interesting point is the magnitude of change in productivity over time: the Geophysics Laboratory, which had no source papers in the sample, but received some 37 citations, had a median cited year of 1924, as compared to Oak Ridge whose median cited year was 1955. He also noted that adding in-house and self-citations would have had almost no effect on the ranking of the top ten source laboratories.

He finally concludes that

Analysis of literature citations is a useful measure of the significance of research.

Analyses based on

- (1) gross number of citations,
- (2) net number of citations
(in-house and self-citations omitted).
- (3) replicate citations, and
- (4) ratio of citations to papers published give results which are in general agreement.¹⁸

In his 1965 article on networks of scientific papers, Price discusses the pattern of bibliographic references, and the use of this pattern in defining the nature of the scientific research front.¹⁹ He includes a number of points about productivity, as measured by citation rather than publication counts, and shows that the number of citations received by papers from a given year decreases logarithmically, just as the

¹⁸ Ibid., p. 1233.

¹⁹ Derek J. de Solla Price, "Networks of Scientific Papers," Science 149 (July 1965):510-515.

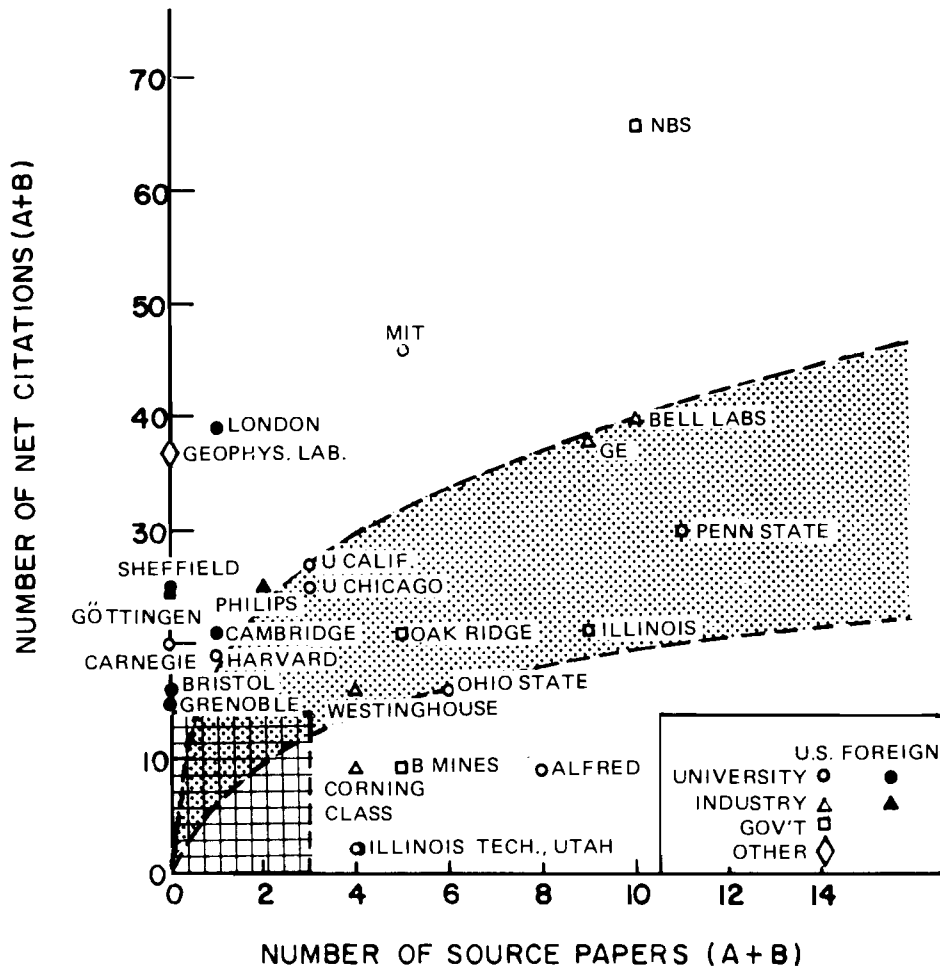

FIGURE 4-5

CORRELATION OF NUMBER OF CITATIONS WITH NUMBER OF PUBLICATIONS
(from Westbrook, 1960)

number of papers produced by different individuals had been shown by Lotka and Shockley to decrease. Figure 4-6, taken from that paper, shows the relative citation frequency for papers cited in the 1961 Citation Index. The most salient point is that "...for large n, the number of papers cited appears to decrease as $n^{2.5}$ or $n^{3.0}$."²⁰ How well this would hold for more recent data based on the much larger Science Citation Index or for combined citations from a number of years would be interesting questions to investigate. Nevertheless, the citation data certainly seem to indicate that the concentration of productivity in talented individuals as shown by their publication rates is also reflected in the concentration of citations to a relatively small number of papers.

In 1972 Cole and Cole published an evaluative paper entitled "The Ortega Hypothesis" which maintained that "...citation analysis suggests that only a few scientists contribute to scientific progress."²¹ Cole and Cole start with the work of Price and Lotka and the inverse square law of productivity, pointing out that using this

...we can estimate that roughly 50% of all scientific papers are produced by 10% of the scientists. What remains problematic is the extent to which the 10% of the scientists who produce 50% of the research publications are dependent on the other 90% of research scientists and the 50% of the total research they produce.²²

Cole and Cole analyze references from papers of various groups of physicists. One set of references was the set of references made by 84 university physicists in their paper which was most heavily cited in the 1965 Science Citation Index. Cole and Cole also analyzed various other samples representing much less selected groups of papers. Cole and Cole found that the authors cited by the most heavily cited papers of the 84 university physicists are far more prestigious than the general population of physicists, whether measured by ranks of departments, by number of awards, or by the number of citations their publications received. From this finding Cole and Cole conclude that "...most of the work used by university physicists in their best papers is produced by only a small proportion of those who are active in the field."²³ Cole and Cole also found, from samples

²⁰Ibid., p. 511.

²¹Jonathon R. Cole and Stephan Cole, "The Ortega Hypothesis," Science 178 (October 1972):368.

²²Ibid., p. 369.

²³Ibid., p. 370.

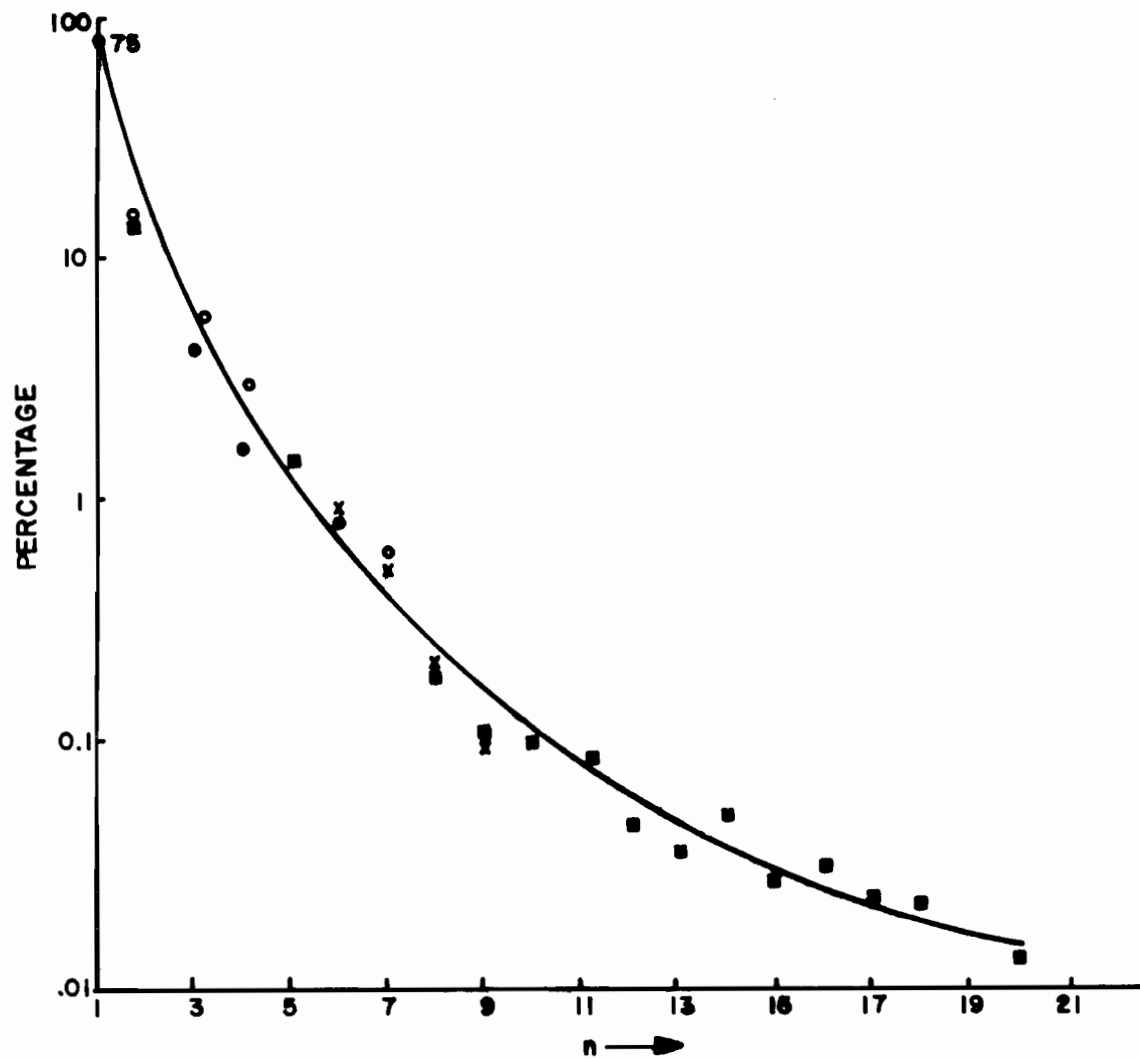

Percentages (relative to total number of cited papers) of papers cited various numbers (n) of times for a single year (1961). The data are from Garfield's 1961 Index (2), and the points represent four different samples conflated to show the consistency of the data. Because of the rapid decline in frequency of citation with increase in n, the percentages are plotted on a logarithmic scale.

FIGURE 4-6

PERCENTAGES OF PAPERS CITED VARIOUS NUMBERS OF TIMES
(from Price, 1965)

of more typical papers, that the scientists cited were among the elite measured by the quantity of their published work.

Cole and Cole's paper has evoked substantial interest, especially because of the suggestion that "...science would not suffer from a reduction in the number of new recruits and an increase in the resources available to the resulting smaller number of scientists."²⁴ Despite the emotional content of that suggestion, it seems clear that there is a sharp concentration of scientific talent among productive scientists, and that this fact should have an impact upon the policy-making process if the overall creative production of scientists is to be maximized.

The studies mentioned to this point have treated publication and citation counts as indicators of scientific activity but have not delved into the nature of the citation process. A series of papers by Moravcsik and his colleagues^{25,26,27} have begun a scrutiny of the citation process. They have concentrated their attention on the literature of physics, and attempted to classify references according to whether the reference is

1. Conceptual or operational; i.e., to distinguish ideas used from tools used.
2. Organic or perfunctory; i.e., to distinguish references necessary to understand the research from perfunctory acknowledgements of other research.
3. Evolutionary or juxtapositional; i.e., to distinguish material used in the same line of research from material in parallel or divergent lines.

²⁴Ibid., p. 374.

²⁵Michael J. Moravcsik, Poovanalingan Murugesan, and Evelyn Shearer, An Analysis of Citation Patterns in Indian Physics, unpublished.

²⁶Michael J. Moravcsik and Poovanalingam Murugesan, Some Results on the Classification of Citation Records of Individual Scientists, unpublished.

²⁷Michael J. Moravcsik and Poovanalingam Murugesan, "Some Results on the Function and Quality of Citation," Social Studies of Science 5 (January 1975):86-92.

4. Confirmal or negational; i.e., to distinguish material the researcher(s) judged to have good quality from material the researcher(s) judged to be poor in quality.

One of their conclusions is a reservation about the use of citations as a measure of quality, since they find a substantial number of perfunctory citations. Table 4-1 summarizes their results for papers from the Physical Review. Because Moravscik's technique requires a detailed reading and comprehension of each paper, the technique is not practical for the large scale analysis of scientific activity. Nevertheless the studies should illuminate the scientific processes underpinning the etiquette of citations.

In a related aspect of the evaluation of scientific productivity a series of studies have attempted to measure the relation between science and technology. These productivity studies trace the scientific to technological innovation process by focusing on the identification and classification of major events.

In a 1966 book Schmookler²⁸ dicusses important innovations in four economic sectors, covering the period 1800 to 1957. These sectors are agriculture, petroleum refining, paper making and railroading. He identifies almost 1,000 inventions and has found that, in almost every case, a technical problem or opportunity acted as the prime stimulus for the invention. While the inventions themselves did not stem from science, he emphasizes that many of the inventions depended on science, although much of the science depended upon was twenty or more years old.

The second widely known productivity study of this type was the HINDSIGHT study,²⁹ in which the Department of Defense (DOD) tried to measure the payoff of investments in science and technology. In HINDSIGHT the DOD chose proven utility in an end item as the importance criterion, and found a large payoff of 10 to 1 from their applied research and development investments. Each of the HINDSIGHT sample cases considered both a predecessor and a successor weapons system, and attempted to measure the value of the difference between the two systems, divided by the applied R&D investment in going from the predecessor to the successor system. They found that old science (pre 1940) was literally priceless to the DOD, but

²⁸Jacob Schmookler, Invention and Economic Growth (Cambridge, Mass.: Harvard University Press, 1966).

²⁹C.W. Sherwin and R.S. Isenson, First Interim Report on Project HINDSIGHT (Summary), (Washington, D.C.: Office of the Director of Defense Research and Engineering, June 30, 1966).

TABLE 4-1

A CLASSIFICATION OF REFERENCES IN 30 ARTICLES IN
PHYSICAL REVIEW, PUBLISHED ON THEORETICAL HIGH
 ENERGY PHYSICS FROM 1968 TO 1972, INCLUSIVE
 (from Moravcsik, 1975)

	Total	'Big' Papers	'Small' Papers
Total Number of References	706	333	373
Total Number of Papers Referred to	575	292	283
Extraneous References (Books, Footnotes, Experimental Papers, Private Communications, etc.)	292	147	145
1. Conceptual	306 (53%)*	158 (54%)*	148 (52%)*
Operational	245 (43%)	120 (41%)	125 (44%)
Neither	41 (7%)	21 (7%)	20 (7%)
2. Organic	345 (60%)	167 (57%)	178 (63%)
Perfunctory	238 (41%)	125 (43%)	113 (40%)
Neither	5 (1%)	3 (1%)	2 (1%)
3. Evolutionary	338 (59%)	168 (57%)	170 (60%)
Juxtapositional	229 (40%)	120 (41%)	109 (39%)
Neither	13 (2%)	11 (4%)	2 (1%)
4. Confirmative	502 (87%)	264 (90%)	238 (84%)
Negational	83 (14%)	39 (13%)	44 (16%)
Neither	26 (5%)	8 (3%)	22 (8%)
Redundant	177 (31%)	97 (33%)	80 (28%)

*Because of the occasional multiple use of a reference, the percentages do not add up exactly to 100%.

that the DOD's more recent investment in basic research had little direct consequence in the change of predecessor to successor systems.

Subsequent to the HINDSIGHT study, the National Science Foundation sponsored the TRACES study,³⁰ to see if links could be established between innovations of social and economic importance and the underlying base of non-mission research. The time scale upon which TRACES focused was much broader than HINDSIGHT; on this time scale, links between basic research and technological innovation were clearly evident.

A follow-on study at Battelle Columbus Laboratories³¹ extended the TRACES case study technique, and looked further into the innovation process.

All of these sample case studies are statistically limited, since the selections of cases was not random. The sample cases were selected because of their impact in a diversity of fields of technology and application. These studies provide much qualitative insight into the research to innovation process. However, it is difficult to quantify their conclusions, or to use these techniques to measure the efficiency or productivity of the process.

³⁰Technology in Retrospect and Critical Events in Science, Illinois Institute of Technology Research, Report prepared for NSF, Washington, 1969.

³¹Interactions of Science and Technology in the Innovation Process, (Columbus, Ohio: Battelle Columbus Laboratories, March 19, 1973), final report prepared for the National Science Foundation, Contract NSF-C667.

V. CORRELATIONS WITH NON-LITERATURE MEASURES

A. Introduction

This chapter discusses 24 papers in which bibliometric measures, based on publication and citation counts, have been compared to other measures of research productivity. In the aggregate these studies provide strong support for the use of literature-based techniques, and also illustrate the range of analyses for which these techniques are appropriate.

The fundamental problem in any discussion of the validity of indicators of scientific productivity is the fact that there is no absolute standard of measure of such productivity. The classic scientific approach would be to obtain the best possible set of indicators of quality or productivity from the literature, and validate these indicators through correlations and similar analyses with independent, objective and quantitative measures of scientific productivity and quality. Unfortunately, no such set of independent, objective, quantitative indicators exists. Thus, at present, the relationships between bibliometric measures and other measures may only be validated using a "rule of reason" approach.

It should be reiterated that the journal literature is widely accepted as the prime means for recording scientific advances in most fields.¹ Thus, the existence of a positive correlation between any reasonably based literature measure, and any other reasonably based measure of scientific advancement may be expected. The papers discussed in this chapter show that such positive correlations are typical.

Bibliometric measures have been applied to evaluation of scientists, academic departments, and scientific publications. For publications, the typical procedure compares the citation rate of a publication with a formal or informal peer evaluation of the same publication. Peer evaluations have been found to correlate positively with citation rates, with the more highly cited publications generally more highly rated by the scientists' peers.

When applied to scientists, the evaluation may use either publication or citation rate as the bibliometric indicator, and may use a number of independent measures of eminence ranging from awards and listings to academic rank or affiliation. In almost all cases, the bibliometric measures of eminence ascribed to groups of scientists will correlate reasonably well, in the range of 0.5 to 0.8, with the other eminence rankings.

¹ Henry W. Menard, Science: Growth and Change (Cambridge, Mass.: Harvard University Press, 1971), p. 6.

The third type of comparison looks at departmental publication or citation rates, compared with the Cartter² or the Roose-Andersen³ reports. These reports rank order academic departments in the U.S. by quality of their graduate faculty and effectiveness of their graduate educational programs. Both Cartter and Roose-Andersen used thousands of questionnaires to generate these rankings. Most studies of this type show correlations in the 0.7 to 0.9 range.

B. General Comments on the Twenty-four Studies

Eight of the 24 studies selected to compare bibliometric with non-bibliometric measures use the Cartter or the Roose-Andersen studies as the non-bibliometric measure of quality of university departments.

Allan M. Cartter⁴, in a 1966 study for the American Council on Education, assessed the quality of graduate education in the United States. In this study, essentially a survey analysis of informed opinions, nearly 900 department chairmen, 1700 outstanding senior scholars and scientists and 1400 younger academicians participated in the assessment.

The Cartter report selected 30 academic fields for study. These fields were selected to provide as much overlap with earlier studies as possible and to include most of the major disciplines in the arts and sciences. The survey covered doctoral work in 106 different institutions. The questionnaire asked two basic questions:

1. Which of the terms below best describe your judgment of the quality of the graduate faculty in your field at each of the institutions listed? Consider only the scholarly competence and achievements of the present faculty.

1. Distinguished
2. Strong
3. Good
4. Adequate
5. Marginal
6. Not sufficient to provide acceptable doctoral training
7. Insufficient information

²Allan M. Cartter, An Assessment of Quality in Graduate Education (Washington, D.C.:American Council on Education, 1966).

³Kenneth D. Roose and Charles J. Andersen, A Rating of Graduate Programs (Washington, D.C.:American Council on Education, 1970).

⁴Cartter, An Assessment of Quality in Graduate Education.

2. How would you rate the institutions below if you were selecting a graduate school to work for a doctorate in your field today? Take into account the accessibility of faculty and their scholarly competence, curricula, educational and research facilities, the quality of graduate students and other factors which contribute to the effectiveness of the doctoral program.

1. Extremely attractive
2. Attractive
3. Acceptable
4. Not attractive
5. Insufficient information⁵

In 1969, K.D. Roose and C.J. Andersen⁶ performed a rating of graduate programs also for the American Council on Education, as a follow-on and extension of the Cartter work. The report was similar in concept and conduct to the Cartter report. The Roose-Andersen report was based on the completion of a questionnaire by some 6,000 scholars, a larger number than surveyed by the Cartter report. The Roose-Andersen report included seven additional disciplines and twenty-five additional institutions.

The Cartter and Roose-Andersen studies are the direct basis for a number of comparative studies, and add support to many others. Table 5-1 summarizes all of the studies which will be described in some detail in the next section.

The table is divided into three sections with an alphabetical listing of papers within each section. The first section covers papers using correlation measures; the second section covers papers using other quantitative measures, and the third covers papers using qualitative measures.

The first section of the table identifies the author of the paper, the scientific field studied, the correlation measured, and the subject to which the measures were applied.

The concentration of studies with correlations in the 0.6 to 0.8 range should be noted. Most of these studies compare the publications or citations of scientists with other measures of eminence; some studies also look at departmental rankings. The one study with a notably low correlation of 0.21, is the Bayer

⁵Cartter, An Assessment of Quality in Graduate Education, p. 127.

⁶Roose and Andersen, A Rating of Graduate Programs.

TABLE 5-1

PAPERS COMPARING BIBLIOMETRIC AND NON-BIBLIOMETRIC MEASURES

Section 1: Papers using Correlation Measures

AUTHOR	FIELD	CORRELATION	APPLICATION
Bayer and Astin	All Science	0.56	Scientists: Pubs vs. Academic Rank
Bayer and Folger	Biochemistry	0.21	Scientists: Cites vs. Graduate School Rank
Bush, Hamelman & Staaf	Economics	0.93-0.98	Journals: Citations vs. Peer Rankings
Cartter	Economics, English, Political Science	0.7-0.85	Departments: Pubs vs. Cartter Rank
Clark	Psychology	0.67	Scientists: Cites vs. Eminence
Cole and Cole	Physics	0.6-0.7	Scientists: Cites vs. Eminence
DeWitt	Chemistry	0.8-0.9	Scientists: Cites vs. Roose-Andersen Department Rank
Drew and Karpf	Math, Physics, Chemistry	0.76-0.87	Departments: Pubs vs. Cartter and Roose-Andersen Rank
Hagstrom	Biology, Physics, Chemistry and Math combined	0.67-0.69	Departments: Cites or Pubs vs. Cartter Rank

TABLE 5-1 (Continued)

PAPERS COMPARING BIBLIOMETRIC AND NON-BIBLIOMETRIC MEASURES

Section 1: Papers using Correlation Measures

AUTHOR	FIELD	CORRELATION	APPLICATION
Lightfield	Sociology	0.2-0.8	Scientists: Pubs and Cites vs. Cartter Rank and Recognition
Shaw	Agriculture	0.34-0.54	Scientists: Pubs vs. Shockley Merit Index
Solomon: Knudsen-Vaughan; Glenn-Villemez	Sociology	0.81	Departments: Pubs vs. Cartter Rank

Section 2: Papers using other Quantitative Measures

AUTHOR	FIELD	APPLICATION
Cohen-Shanin	Plant Hormones	Articles: Peer Evaluations Correspond with Citation Rates to Papers
Crane	Biology, Psychology, Political Science	Scientists: Pub Rates Correspond with Eminence Measure
Gillmor	Atmospheric and Terrestrial Physics	Articles: Editor Evaluations Correspond with Citation Rates
Harrold	Military R&D	Laboratories: Publications and Patents do not Correlate with Military Laboratory performance-but do Correlate with the Number of Civilian Scientists

TABLE 5-1 (Continued)
 PAPERS COMPARING BIBLIOMETRIC AND NON-BIBLIOMETRIC MEASURES

Section 2: Papers using other Quantitative Measures		
AUTHOR	FIELD	APPLICATION
Small	Chemistry	Articles: Cites Correspond with Peer Evaluation
Virgo	Medicine	Articles: Cites Correspond with Peer Evaluation
Zuckerman	All Fields	Scientists: Nobel Laureates are Prolific Publishers
Section 3: Papers Using Qualitative Measures		
AUTHOR	FIELD	APPLICATION
Middleton	Sedimentary	Articles: Selection Criteria Correspond with Citation Rates
Anonymous (in <u>Mosaic</u>)	Criminology	Articles: Peer Evaluations Correspond with Citations
Myers	Psychology	Scientists: Meritorious Groups Correspond with Citations

and Folger study,⁷ which compares the citation records of individual scientists a few years out of graduate school with graduate school rank. Since a reasonably wide variance in the graduates from a given school is likely and the scientists had so few years in which to establish themselves, the low correlation is not surprising.

The papers in the second section of the table contain quantitative measures which are not correlations. Their conclusions, however, are substantially the same as the conclusions of the papers showing direct correlation measures. The papers are separated only because the correlation measures can be readily compared and the measures used in the second section cannot. In almost every case a relatively substantial agreement exists between the bibliometric measure and the other measure, even though these agreements are not expressed in terms of either product moment or Spearman rank correlations.

Harrold's paper,⁸ which looked at military R&D laboratories, is the one study in which no relationships were found between bibliometric measures and non-bibliometric measures. The results of the study show that overall laboratory performance does not seem to correlate with publications or patents. However, the performance of the laboratory was based on its military R&D mission which might not be reflected in its publications. It was noted that those military laboratories which had a substantial fraction of civilian scientists on their staff published far more papers than those staffed predominantly by military scientists.

The three papers in the third section of the table compare bibliometric measures with qualitative measures of eminence. In every case the authors state that, although a qualitative rather than a quantitative measure was used, a positive association exists between the bibliometric and non-bibliometric measures.

C. Descriptions of Individual Studies Comparing Bibliometric and Non-Bibliometric Measures

1. Studies Using Correlation Measures

Each of the individual studies listed on Table 5-1 is briefly described in the order in which the study appeared on that table.

⁷ Alan E. Bayer and John Folger, "Some Correlates of a Citation Measure of Productivity in Science," Sociology of Education 39 (1966):381-390.

⁸ Raymond W. Harrold, "An Evaluation of Measureable Characteristics Within Army Laboratories," IEEE Transactions on Engineering Management EM-16 (February 1969):16-23.

Bayer & Astin

In 1975, Bayer and Astin⁹ studied sex differentials in the academic reward system in an attempt to determine if there has been any recent improvement in the status of female members of college faculties.

The research surveyed 100,000 college and university faculty members throughout the United States. Three criterion variables were used in the survey: academic rank, tenure status, and base institutional salary. Four sets of predictor variables were grouped in the following manner:

demographic characteristics,
educational characteristics,
professional work variables, and
institutional characteristics.

A step-wise regression was performed: of the 60 potential predictors 19 entered the regression.

The bulk of the research examined sex differentials in rank, controlling for the major demographic, educational and institutional variables. Table 5-2 shows that the most significant predictor of rank was the number of articles published. The zero order correlation is 0.56 between number of articles published and academic rank.

Bayer & Folger

In 1966, Bayer and Folger¹⁰ studied correlations between citations and productivity in science by comparing the citations received by 467 scientists earning their doctorates in biochemistry in 1957 and 1958, with the Cartter ranking of their graduate schools. The citations came from the 27 biochemistry journals covered by the SCI in 1964.

Bayer & Folger show that three times as many graduates of high quality than low quality institutions produced papers which were cited more than 15 times. They also show that twice as many graduates of the lower quality departments had no citations. Bayer & Folger obtained an overall correlation coefficient of 0.21 between Cartter rank and citation counts significant at the .001 level. They also compared I.Q. data, and found no apparent I.Q.

⁹Alan E. Bayer and Helen S. Astin, "Sex Differentials in the Academic Reward System," Science 188 (May 1975):96-80.

¹⁰Bayer and Folger, "Some Correlates of a Citation Measure of Productivity in Science."

TABLE 5-2

PREDICTORS OF ACADEMIC RANK
(from Bayer & Astin, 1975)

Predictors of academic rank, 1972-73. $R=.790$. All variables are listed in order of entry in a stepwise regression equation. Partial r of sex: female is $-.130$ ($F=85.92$) after allowance for all the variables listed. $F>6.64=p<.01$: $F>10.83=p<.001$.

Variable	Zero order r	Final multiple regression equation	
		Beta (path coefficient)	F ratio
Number of articles published	+ .559	+ .231	363.47
Age	+ .531	+ .233	329.22
Highest degree: doctorate	+ .443	+ .222	151.22
Years of continuous service at institution	+ .459	+ .150	188.62
Time spent in administration	+ .257	+ .111	152.53
Years since highest degree	+ .495	+ .168	151.60
Field: biological science	+ .071	- .060	42.01
Institution: 4-year college	- .032	+ .083	83.52
Political orientation: conservative	+ .008	+ .037	16.48
Department: humanities	- .088	- .050	26.28
Number of books published	+ .373	+ .066	43.11
Highest degree: baccalaureate	- .144	- .078	54.21
Highest degree: master's	- .419	- .115	41.74
Department: fine arts	- .038	+ .036	15.47
Field: engineering	+ .096	+ .037	17.14
Race: white	+ .070	+ .031	12.51
Department: business	+ .003	+ .024	7.01
Career interruption	+ .085	- .027	8.73
Department: education	- .034	- .025	6.72

effect on citation counts when the Cartter rank of the graduate school is accounted for. Table 5-3 summarizes their data.

Bush, Hamelman and Staaf

Bush, Hamelman and Staaf¹¹ compared a citation ranking of 14 economics journals with a peer ranking of the same journals and found a high correlation. The citation rank was based on citations received by each journal from itself and from each of the thirteen other journals, over a five year period. The peer ranking was taken from peer ranking of 87 economics journals reported by Hawkins, Ritter and Walter.¹² Their Delphi study utilized 160 economists as the peer group surveyed. The results are given in Table 5-4 which shows that the rankings are remarkably close. The citation ranking including journal self-referencing correlates with the peer ranking at 0.93, while the citation ranking excluding self-referencing correlates with the peer rank at a level of 0.98.

Cartter

The Cartter report itself contains data comparing publications with departments. The fields of economics, political science and English were examined using publication data for the resident faculty. For these three fields, the Cartter report includes graphs plotting the quality of graduate faculty against a publication index (article equivalents per year--with notes, book reviews and books transformed into article equivalents). Spearman rank and product moment correlation between these publication and quality indices range from 0.71 to 0.85. Figure 5-1 shows this data.

Clark

In a heavily cited and influential 1957 study of America's psychologists, Clark¹³ surveyed psychology as a growing profession. Part of the survey attempted to identify eminent practitioners in the field. The study analyzes the relation of eminence to other criteria.

¹¹William C. Bush, Paul W. Hamelman and Robert J. Staaf, "A Quality Index for Economics Journals," Review of Economics and Statistics 56 (February 1974):123-125.

¹²R.G. Hawkins, L.S. Ritter and I. Walter, "What Economists Think of Their Journals," New York University, Graduate School of Business Administration Working Paper Series, No. 72-36, 1972.

¹³Kenneth E. Clark, America's Psychologists: A Survey of a Growing Profession (Washington, D.C. American Psychological Association, 1957).

TABLE 5-3

DEPARTMENT QUALITY BY CITATION COUNT:
 1957-1958 BIOCHEMISTRY DOCTORATES
 (from Bayer & Folger, 1966)

Number of Citations	Department Quality					
	Low (under 2.00)		Middle (2.00-2.99)		High (3.00 +)	
	N	%	N	%	N	%
None	36	38.7	59	35.3	40	19.3
1-5	31	33.3	64	38.3	75	36.3
6-15	20	21.5	34	20.4	52	25.1
16 or more	6	6.5	30	6.0	40	19.3
Total	93	100.0	167	100.0	207	100.0
	r=.214		F _{1,405} =22.32		p<.001	

TABLE 5-4

COMPARISON OF PEER AND CITATION RANKING
OF ECONOMICS JOURNALS
(adapted from Bush, Hamelman & Staaf, 1974)

Journal	Citation Ranking Including Journal Self Referencing	Citation Ranking Excluding Journal Self Referencing	Peer Ranking by Delphi Technique
Am Econ Rev	1	1	1
Econometrica	2	2	2
Rev Ec and Stat	3	4	5
J Pol Econ	4	3	3
J Am Stat Assoc	5	6	6
Qty J Econ	6	5	4
J Finance	7	8	8
Nat Tax J	8	9	11
Cand J Econ	9	11	9
Int Econ Rev	10	7	7
South Ec J	11	10	10
Ind Lab Rel Rev	12	12	12
Land Econ	13	13	13
Qty Rev Ec Bu	14	14	14

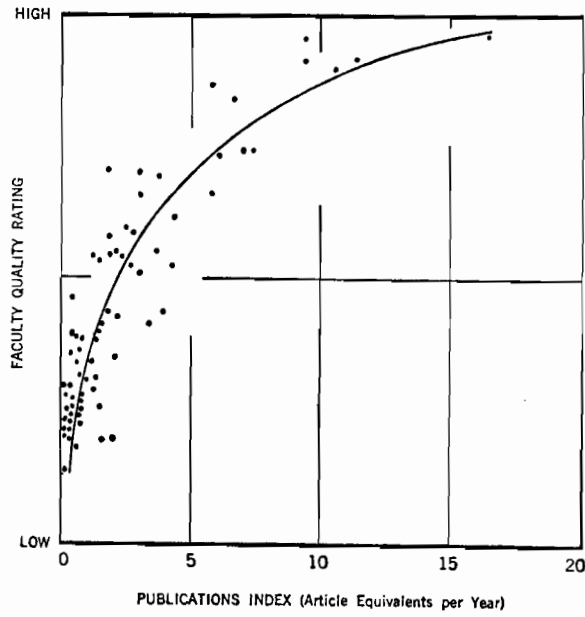

Relationship of rated quality of graduate faculty to index of publications, 71 economics departments.

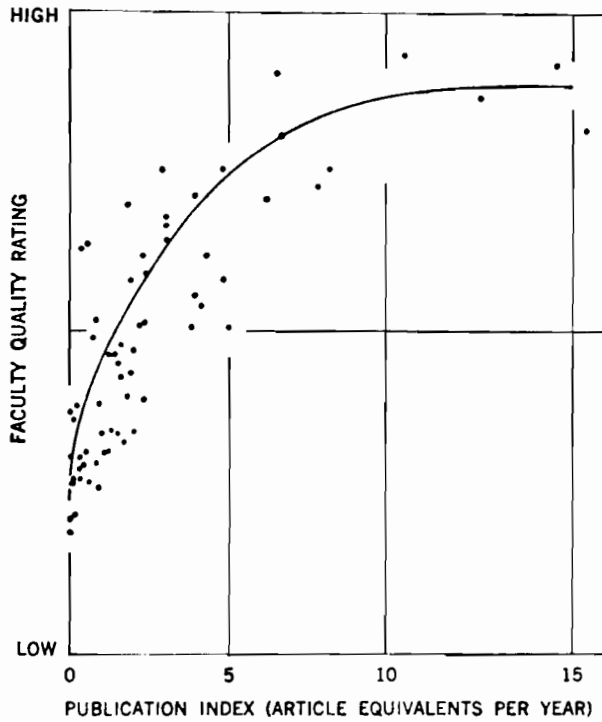

Relationship of rated quality of graduate faculty to index of publications, 64 political science departments.

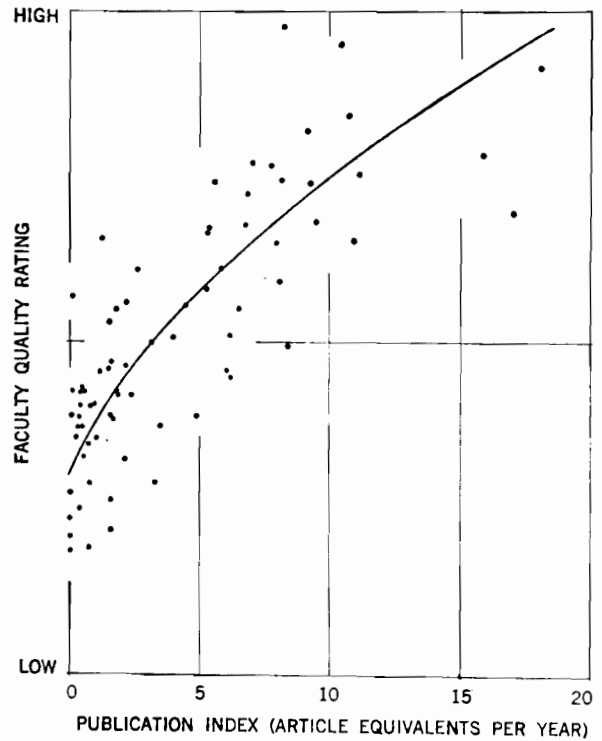

Relationship of rated quality of graduate faculty to index of publications, 74 English departments.

FIGURE 5-1

PUBLICATION INDICES FROM CARTTER REPORT (1966)

The eminent psychologists studied in the project were selected by a two-stage process. Clark started with all members of the American Psychological Association (APA) who received their PhDs between 1930 and 1944; then he counted the total number of entries in Psychological Abstracts for these individuals. For each of the individuals who received their doctorates in the five year periods 1930-1934, 1935-1939, and 1940-1944, the top 150 individuals in terms of publication counts were selected as the "high producers" in the field.

Separate lists of high producers and the remaining names from the sample were submitted to various judges. The judges nominated from the remainder of the list those whom they thought should have been included in the "high producer" list; the new listing was then renamed "highly visible" list. Other groups of judges were asked to select individuals in specific areas of psychology who were significant contributors. Additional variables used to measure the eminence of the subjects were APA office held, citations received from journals, counts of publications listed in Psychological Abstracts, and counts of citations from the Annual Review of Psychology.

Table 5-5 summarizes the intercorrelations of the indices of eminence for the highly visible person. The highest correlation in the table is the 0.67 between the number of votes received and the journal citation counts.

Cole & Cole

In 1967, Cole and Cole¹⁴ investigated the relationship between quantity and quality of scientific output with a sample of 120 university physicists. The number of their publications was used as the quantity measure; the number of citations to the three most cited papers of each physicist was used as the bibliometric quality measure. The non-literature parameters used to measure recognition were: number of awards, prestige of highest award, ranking of departments, and the percent of the national community of physicists familiar with the individual's research.

Cole and Cole found that the quality and quantity of research are significantly related, regardless of the quality measure employed. When the bibliometric quality measure was applied, quality correlated highly with quantity at a level of $r=0.72$. Moreover, they found that the bibliometric quality measure correlated highly with other non-literature based quality measures, especially number of awards at $r=0.67$, and recognition at $r=0.64$. Table 5-6 substantiates these conclusions.

¹⁴Stephen Cole and Jonathan R. Cole, "Scientific Output and Recognition," American Sociological Review 62 (1967):377-390.

TABLE 5-5

INTERCORRELATIONS OF INDICES OF EMINENCE
(from Clark, 1957)

	1950-53 <u>Psychological Abstract Counts</u>	Annual <u>Review Citations</u>	Journal <u>Citation Counts</u>	APA <u>Offices Held</u>	Number <u>of Votes Received</u>
<u>Total Psychological Abstract Counts</u>	.52	.41	.45	.30	.44
<u>1950-53 Psychological Abstract Counts</u>		.03	.36	.19	.43
<u>Annual Review Citations</u>			.60	.31	.58
<u>Journal Citation Counts</u>				.38	.67
<u>APA Offices Held</u>					.64
<u>Number of Votes Received</u>					

These correlations are markedly influenced by the direct selection of the large part of this group on the variable Total Psychological Abstracts Counts and the effect this has on the restriction in the range of all variables.

TABLE 5-6

SCIENTIFIC OUTPUT AND RECOGNITION
(adapted from Cole & Cole, 1967)

Coefficients of Correlation Between Quantity and Quality
of Research and Three Measures of Recognition

Bibliometric Measures	Measures of Recognition		
	Prestige of highest award	Number of awards	Rank of Department
Quantity and Quality of Research			Percent of Physicists Familiar with Individuals' Research
Quantity	.35	.46	.24
Number of papers per year	.28	.32	.19
Quality	.41	.67	.33

DeWitt

In an unpublished National Science Foundation study, DeWitt¹⁵ studied inputs to decision-making in chemistry. As his sample, he used the chemistry faculty of the 79 Roose-Andersen ranked schools, covering 1966 to 1970 for publications, 1968 to 1972 for citations. This sample produced a total of 2,700 authors, 32,000 papers, and 328,000 citations. DeWitt found that the citations/man correlated with the Roose-Andersen ranking of the chemistry department with a coefficient of 0.8. He also found essentially the same correlation when he compared citations/man versus publications/man. When publications/man were weighted by a measure of the prestige of the journals, a correlation of 0.9 was found.

Drew and Karpf

In a 1975 Rand Corporation study, Drew and Karpf¹⁶ reported on the correlations between the Roose-Andersen and Cartter ratings of universities, and publication counts based on 20 top journals in the fields of mathematics, physics and chemistry. The correlations range from 0.70 to 0.87. Drew and Karpf used the actual Roose-Andersen and Cartter report scores. Their results are summarized in Tables 5-7 and 5-8; these correlations are based on counts of 5,000 to 6,000 papers in mathematics, 18,000 to 20,000 papers in physics, and 9,500 to 14,000 papers in chemistry. Drew and Karpf also attempted to isolate a quality effect using Garfield's impact factor as a measure of journal quality. They did not find any strong quality trend among the 20 journals considered for each of the fields. Overall, their results are very much in accord with the high correlations reported in Chapter X, except that Chapter X covers many more fields, and shows that there is a substantial quality effect when the influence of a journal is added to the publication count.

Hagstrom

In a 1971 study Hagstrom¹⁷ compared inputs, outputs, and the prestige of American university science departments. His basic prestige measure was the Cartter ranking of 125 sample departments. Hagstrom sent activity questionnaires to the facul-

¹⁵ Thomas W. DeWitt, Further Inputs to Decision Making, National Science Foundation, unpublished.

¹⁶ David E. Drew and Ronald S. Karpf, Evaluating Science Departments: A New Index. Rand Corporation Paper Series, October 1975.

¹⁷ Warren O. Hagstrom, "Inputs, Outputs, and the Prestige of University Science Departments," Sociology of Education 44 (Fall 1971):375-397.

TABLE 5-7

CORRELATIONS BETWEEN THE CARTER RATINGS AND
PUBLICATION COUNTS FOR 20 JOURNALS
(adapted from Drew & Karpf, 1975)

	1960	1961	1962	1963	60-63
Mathematics	.84	.82	.86	.86	.87
Physics	.80	.83	.84	.84	.84
Chemistry	.84	.82	.80	.76	.86

TABLE 5-8

CORRELATIONS BETWEEN THE ROOSE-ANDERSEN RATINGS
AND PUBLICATION COUNTS FOR 20 JOURNALS
(adapted from Drew & Karpf, 1975)

	1965	1966	1967	1968	65-68
Mathematics	.78	.70	.75	.71	.76
Physics	.80	.82	.84	.84	.83
Chemistry	.86	.81	.87	.83	.87

ties of the departments, obtained career data for these faculty members from American Men of Science, and looked up citations to their publications listed in the 1966 Science Citation Index.

Table 5-9 shows the sample of departments distributed according to the Cartter rank, and Table 5-10 gives the factor analysis of the department quality indicators. Research articles have the highest loading followed closely by citations and then by quality of graduate faculty.

Table 5-11 shows the product moment correlations among the selected characteristics of these 125 departments. The quality of graduate faculty is most highly related to citations to works and next most highly related to research articles. In turn these two variables correlate at 0.79. Hagstrom has made an extensive study and discusses the data at length.

Lightfield

In a 1971 study Lightfield¹⁸ considered the relationship between output and recognition for sociologists. The population for this study consisted of all sociologists who were listed in the American Sociological Association directory for 1967 who had received PhDs between 1954 and 1963. A random sample of 200 was selected from the population.

The quantity of research was calculated by summing all research publications, excluding abstracts, dissertations, book reviews, and research notes. Articles, editorships of books, or chapters in books were rated as an article; authorship of a book was counted as 1 to 4 articles depending upon the length of the book. Junior and senior authorships were not differentiated.

Lightfield measured the quality of a sociologist's research by the number of citations to his three most cited papers. These citations were culled from three journals: the American Sociological Review, the American Journal of Sociology and Social Forces. Lightfield considered these three journals to be the core of the sociological literature. The status of the sociologist's department was based on the Cartter rating, and the recognition of the sociologist on a survey of faculty members in three universities. Figure 5-2 shows partial correlation coefficients. Quantity and quality are strongly correlated. The multiple correlation for the dependent variable of recognition, with the quantity and quality of the publications was found to be 0.79. When the third independent variable of department rank was correlated, the coefficient only became 0.80.

¹⁸Timothy E. Lightfield, "Output and Recognition of Sociologists," American Sociologist 6 (May 1971):128-133.

TABLE 5-9

DISTRIBUTION OF 125 SAMPLED DEPARTMENTS BY RATED QUALITY OF
GRADUATE FACULTY (SAMPLE SIZE GREATER THAN FIVE)
(from Hagstrom, 1971)

Quality Score	Number of Departments	Per Cent
Distinguished, 4.01-5.00	11	9
Strong, 3.01-4.00	22	18
Good, 2.75	16	13
Adequate Plus, 2.25	17	14
Not in ACE Sample, 1.85	24	19
Rated Adequate or Less, 1.50	<u>35</u>	<u>28</u>
Total	125	101

TABLE 5-10

FACTOR ANALYSIS OF DEPARTMENT QUALITY INDICATORS
(from Hagstrom, 1971)

Unrotated loadings of the first factor extracted with
Guttman's Image Factoring Procedure, Ten Items, 188
Departments with sample size greater than two

Variable	Loading
Research Articles 1961-1966	.780
Citations to Works 1966	.766
Quality of Graduate Faculty	.720
Score of Highest Award	.613
Per Cent Holding Offices in Societies	.491
Rating of Highest Government Advisory Committee Position	.487
Undergraduate Selectivity	.478
Review Articles 1961-1966	.440
Books in Careers	.388
Textbooks in Careers	.266

TABLE 5-11

PRODUCT-MOMENT CORRELATIONS AMONG SELECTED CHARACTERISTICS OF 125 DEPARTMENTS IN BIOLOGY, MATHEMATICS, PHYSICS AND CHEMISTRY (SAMPLE SIZE GREATER THAN FIVE)*
(from Hagstrom, 1971)

	Variable Number													Mean
	<u>1</u>	<u>2</u>	<u>3</u>	<u>4</u>	<u>5</u>	<u>6</u>	<u>7</u>	<u>8</u>	<u>9</u>	<u>10</u>	<u>11</u>	<u>12</u>	<u>13</u>	
1. Quality of Graduate Faculty	--													2.42
2. Department Size (Faculty)	57	--												27.1
3. Citations to Works, 1966	69	40	--											6.48
4. Research Articles, 1961-1966	67	40	79	--										6.33
5. Score of Highest Award	58	36	54	52	--									25.1
6. Rating of Highest Govt. Adv. Committee	45	35	45	36	42	--								2.23
7. % Holding Offices in Societies	47	31	37	39	40	39	--							34.2
8. Mean Quality of Ph.D. University	65	33	45	41	38	37	26	--						3.39
9. Mean Selectivity of B.A. Institution	53	23	32	30	21	18	16	53	--					3.39
10. Mean Number of Post-Doctoral Fellows	63	38	61	64	48	37	37	39	37	--				60.9
11. Undergraduate Selectivity	59	22	38	40	37	20	29	40	56	39	--			58.8
12. % Having Extramural Research Grants	45	29	46	55	33	27	23	31	30	47	26	--		78.5
13. Mean Time Spent on Research	46	29	47	60	26	18	12	31	36	48	31	61	--	1.73
14. Mean Years Since Doctorate	24	21	15	03	31	33	39	19	01	20	11	-11	-11	15.8

*Decimal Points and Plus Signs Omitted.

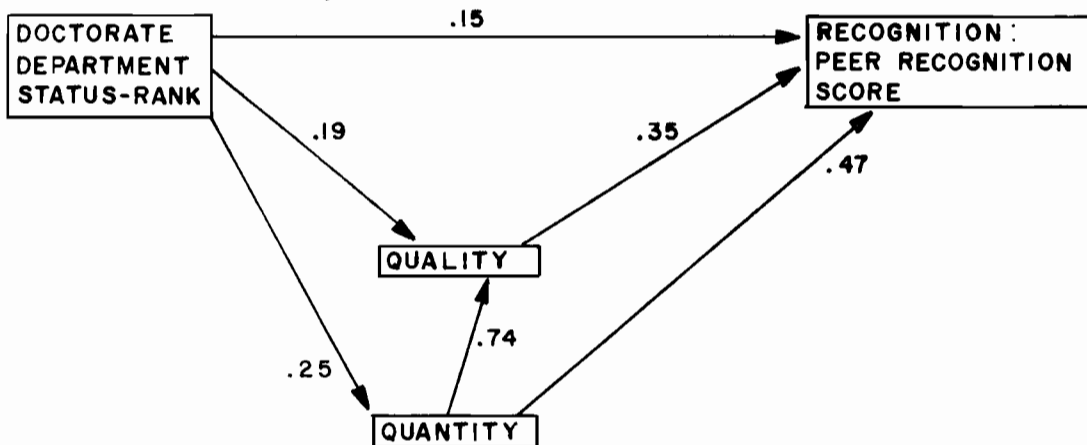

PARTIAL CORRELATION COEFFICIENTS FOR INDEPENDENT VARIABLES ASSOCIATED WITH PEER RECOGNITION OF THE 200 SOCIOLOGISTS.

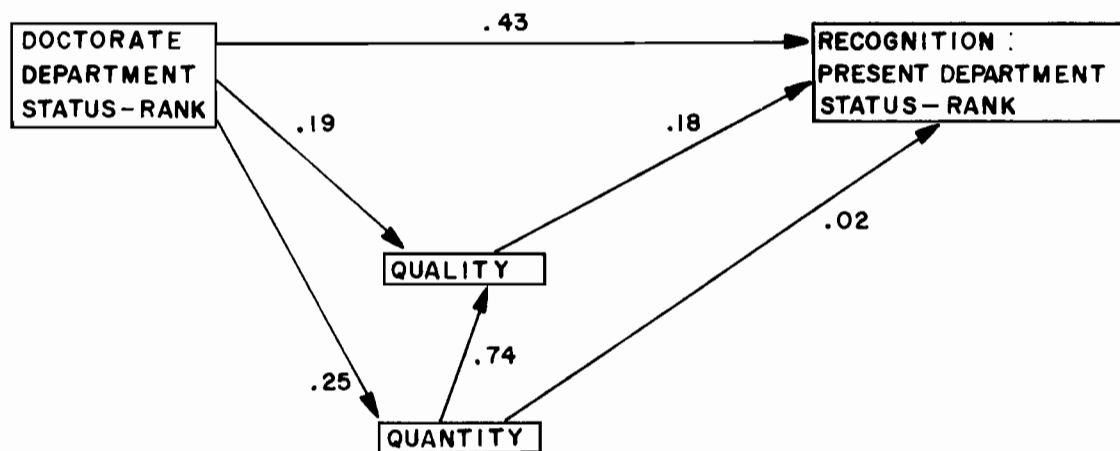

PARTIAL CORRELATION COEFFICIENTS FOR INDEPENDENT VARIABLES ASSOCIATED WITH PRESENT DEPARTMENT STATUS-RANK OF THE 200 SOCIOLOGISTS.

FIGURE 5-2

CORRELATIONS IN SOCIOLOGY
(adapted from Lightfield, 1971)

Lightfield concludes that

...the discipline of sociology does not reward and recognize the quality of the researcher's efforts to the extent that has been supposed. Certainly with respect to recognition by peers, the quantity of one's publications is as important, if not more important, than the quality.¹⁹

He also points out that

The status rank of the department where a sociologist receives his PhD degree appears to have a direct effect on the quantity and quality of his publications.²⁰

Finally, he remarks that

The data also show a relatively high consistency between quality publications and continued research output for a sociologist in the first several years of his professional career. If a sociologist is productive during his initial years, he is likely to remain so; conversely, if he does not publish a quality piece during his initial years, he is not likely to do so later.²¹

Shaw

In 1967, Shaw²² reported on the use of quality and quantity of publications as criteria for evaluating scientists at the Agricultural Research Service (ARS). The various analyses in the report include publication rate trends compared with age and with Civil Service grade (GS) ranking. The analyses are based on the complete publication records of some 3,000 ARS scientists who range in age from 19 to 69 and in GS grades from 7 to 18. The total publications/scientist ranged from 0 to 278.

¹⁹Ibid., p. 133.

²⁰Ibid., p. 133.

²¹Ibid., p. 133.

²²Byron T. Shaw, The Use of Quality and Quantity of Publication as Criteria for Evaluating Scientists (Washington, D.C., U.S.D.A. Miscellaneous Publication No. 1041, January, 1967).

Shaw found that, when the quality of publications is considered along with the quantity, there is an even more widespread difference between scientists than when quantity is considered alone. Shaw devised a publication score which is the sum of an adjusted publication figure (taking into account multiple authors, etc.) and a peer quality measure for individual papers. He found, for example, that the mean publication score on a per year basis ranges from 1.8 for scientists in GS grade 7, to 45.7 for scientists in GS grade 15. Shaw also used a Shockley "merit index" for 1,327 scientists, and compared that with peer evaluation of the scientists' productivity. The Shockley merit index for an individual is defined as the fraction of employees in the same age whom he exceeds in salary. Thus the person with the top salary would have an index of 1. The merit index correlated 0.34 to 0.54 with various publication indices.

Table 5-12 summarizes the GS rank and publication record data and shows, as expected, that publications increase with GS rank. Table 5-13 shows the correlation between merit index and two publication measures for the scientists. It appears that there has been a substantial increase in the association between publications and salary over the ten years from 1955 to 1965.

Solomon

In 1972 Solomon²³ compared the correlations of the Cartter and the Roose-Andersen rankings for graduate programs in sociology with a set of productivity indexes compiled from published books and major articles. Solomon's study reviewed and combined the studies of Glenn-Villemez²⁴ and Knudsen-Vaughan.²⁵ As in other sociology studies, a publication index was derived by weighting monographs, textbooks, edited books, articles, and so forth. The Spearman rank correlation obtained was 0.81 on a departmental basis, and 0.62 on a per person productivity basis for the departments. The per person productivity index was derived by estimating the average number of faculty members resident within the department for an appropriate time period.

²³ Warren E. Solomon, "Correlates of Prestige Ranking of Graduate Programs in Sociology," American Sociologist 7 (May 1972):13-14.

²⁴ Norval D. Glenn and Wayne Villemez, "The Productivity of Sociologists at 45 American Universities," American Sociologist 5 (August 1970):244-252.

²⁵ Dean D. Knudson and Ted R. Vaughan, "Quality in Graduate Education: A Re-evaluation of the Rankings of Sociology Departments in the Cartter Report," American Sociologists 4 (February 1969):12-19.

TABLE 5-12

PUBLICATION FREQUENCY FOR ARS SCIENTISTS

Means of publication records of ARS scientists to Jan. 1, 1965, and number of respondents used in calculating the means, by grade of scientist¹

Item	Grade						
	7	9	11	12	13	14	15
Number of respondents	149	328	614	820	614	303	185
Publications:							
Total, mean	1.960	4.896	9.836	16.399	27.399	44.584	63.151
Per year, mean	.327	.651	.914	1.315	1.695	2.004	2.443
Publication credit:							
Total, mean	.638	2.096	5.047	9.995	16.901	26.361	36.936
Per year, mean	.114	.288	.485	.813	1.140	1.227	1.474
Number of respondents ²	124	276	566	752	556	288	175
Publication score:							
Total, mean	13.202	52.116	149.816	293.914	516.763	861.726	1,187.269
Per year, mean	1.814	6.657	13.588	23.080	31.559	38.150	45.714

¹Any 2 means not underscored by the same line are significantly different at less than the 1-percent level. Any 2 means underscored by the same line are not significantly different at the 5-percent level.

²Certain high responses were not used in calculations relating to publication scores.

(from Shaw, 1967)

TABLE 5-13

CORRELATION BETWEEN MERIT AND PUBLICATION
INDICES FOR ARS SCIENTISTS
(from Shaw, 1967)

Correlation coefficients between merit index and
2 publication measures for 2 periods of time for
the 1,327 scientists employed continuously by ARS
since January 1, 1955

Measures compared	Coorelation coefficient
Merit index June 30, 1956, and publications per year to January 1, 1955-----	0.339**
Merit index June 30, 1956, and publication score per year to January 1, 1955-----	.389**
Merit index June 30, 1965, and publications per year to January 1, 1965-----	.497**
Merit index June 30, 1965, and publication score per year to January 1, 1965-----	.542**

**Significant at 1-percent level.

This publication weighting technique, summarized in Table 5-14, is typical of social science fields, where books and monographs provide a substantial fraction of the important literature.

2. Studies Using Other Quantitative Measures

The next six papers use quantitative measures other than the correlation coefficient to relate the bibliometric measure to another evaluative one. In almost every case there is a substantial correspondence between the bibliometric measure and the other measure. Most of these papers could probably be recast in such a way that the relationship would approximate the typical correlations of 0.5 to 0.8 which were found in the papers discussed in the previous section.

Cohen-Shanin

In a 1975 manuscript entitled Innovation and Citation, Naomi Cohen-Shanin²⁶ studied the relationship between the quality of a scientific paper and its citation rate. Cohen-Shanin limited her study to a single research area--the role of Kinetine-like substances (plant hormones) in senescence and stress--and based her evaluation on 200 papers published from 1959 through 1966. These papers represented all the articles on the subject in Biological Abstracts for these years.

In order to protect the evaluation from extraneous effects, the evaluators were given the papers with all recognition marks removed. These marks included title, author, name of journal, etc.; only the date of publication was revealed. Each evaluator classified every paper under one of the following categories:

1. papers presenting primary findings (PF)
2. papers presenting primary empirical evidence (PEE)
3. papers presenting empirical reinforcements (ER)
4. non-contributing papers (NC)

It is important to note that the evaluations determined the classification of each paper based on the novelty of its information by relating it to a collection of abstracts of the articles from Biological Abstracts. Using this procedure, the correspondence between the two sets of evaluations was 95%. However, in a preliminary test with a sample of 50 papers when Biological Abstracts was not used as a basis for classification, the classifications were the same in only 68% of the cases.

²⁶ Naomi Cohen-Shanin, Innovation and Citation (Jerusalem: November 1974) unpublished.

TABLE 5-14

PUBLICATION WEIGHTS FOR SOCIOLOGY
(adapted from Solomon, 1972)

Type of Publication	Mean Weight Assigned by Sample of Sociologists	Weight Used in Glenn-Villemez Comprehensive Index
Research and Theoretical Monographs (Books)	33.8 ^b	30
Textbooks (including revisions)	18.1 ^c	15
Edited Books	11.2 ^d	10
Articles in the following journals:		
American Sociological Review	--	10
American Journal of Sociology	9.6 (109) ^a	10
Social Forces	8.0 (107)	8
Sociometry	7.9 (99)	8
British Journal of Sociology	7.9 (95)	7
Social Problems	7.6 (98)	7
Public Opinion Quarterly ^g	7.0 (100)	7
Demography	7.3 (77)	6
Rural Sociology	6.7 (95)	6
Administrative Science Quarterly ^g	6.7 (85)	6
Journal of Marriage and the Family ^g	6.6 (94)	6
Milbank Memorial Fund Quarterly ^g	6.6 (83)	6
American Sociologist	6.3 (106)	6
Sociology of Education	6.2 (81)	5
Sociological Quarterly	6.2 (73)	5
Journal of Health and Social Behavior ^e	6.2 (72)	5
Social Science Quarterly ^{f,g}	6.1 (56)	5
Sociology and Social Research	5.9 (92)	5
Sociological Inquiry	5.9 (75)	5
Pacific Sociological Review	5.7 (82)	5
Sociological Analysis	6.0 (50)	4
Phylon ^g	4.9 (73)	4

^aThe number in parentheses after the mean for each journal is the number of sociologists in the sample of 109 who assigned a weight to articles in the journal.

^bThe median is 20.

^cThe median is 10.

^dThe median is 8.

^eDuring the early part of the period covered by this study, the title of this journal was the Journal of Health and Human Behavior.

^fDuring the early part of the period covered by this study, the title of this journal was the Southwestern Social Science Quarterly.

^gIn these journals, only articles authored by sociologists were counted.

For the bibliometric data Cohen-Shanin measured the number of citations to each paper from its date of publication until the end of 1972. She found that the later in the development of a research area that a paper appears, the shorter the time lag between publication date and citation peak. The citation peak for the earlier papers, those published between 1958 and 1962, took place 6 to 11 years after publication; the citation peaks for papers published in 1963-1964 came about five years after publication; and the peak for papers for 1965 and 1966 was reached three years after being published. To account for these differing time lags in citation peak, Cohen-Shanin used a citation measure based on that five-year interval for each paper in which the midpoint is the peak year of citations.

Cohen-Shanin found that 87% of the papers in the primary categories, PF and PEE, were cited more than 15 times. Seventy-two percent of the third category papers, ER, were cited between 5 and 15 times. Eighty-four percent of the NC papers were cited fewer than 5 times. These results summarized in Table 5-15, lend strong credence to the assertion that scientific quality and citation rate are indeed intimately related.

Crane

In 1965, Crane²⁷ published a paper studying the productivity and recognition of scientists at major and minor universities. The data were drawn from interviews with 150 scientists from three universities that were in the "top stratum" of the American university system. Fields chosen were biology, psychology, and political science. Productivity and recognition indices were based on publications and honors received, with four articles considered the equivalent of one book, etc.

The number of major publications achieved by the top one-third of each professional age group was considered high productivity. Those scientists who had received their PhD within the last five years and were credited with a major publication were considered highly productive. Those who had received their PhD within six to fifteen years and were credited with two to five major publications were also considered highly productive, and so forth.

A series of tables shows various relationships between productivity and other variables. Among the conclusions are that:

1. graduates of major universities are more likely to be highly productive than graduates of minor universities

²⁷ Diana Crane, "Scientists at Major and Minor Universities: A Study of Productivity and Recognition," American Sociological Review 30 (October 1965):699-714.

TABLE 5-15

QUALITY OF SCIENTIFIC ARTICLES VS. RATE OF CITATION
(adapted from Cohen-Shanin, 1975)

Classification	Total Papers in Classification	No. Papers		No. Papers Cited Times/5 Yrs*	No. Papers Cited 0-4 Times/5 Yrs*
		Cited 15 Times & above/5 Yrs*	Cited 5-14 Times/5 Yrs*		
** <u>Primary Papers</u> (PF + PEE)	45	39 (86.7%)	6 (13.3%)	0	
<u>Empirical Reinforcement</u>	47	2 (4.3%)	34 (72.3%)	11 (23.4%)	
<u>Non-Contributing Papers</u>	95	0	15 (15.8%)	80 (84.2%)	
TOTAL	187				

*Citation Peak Period

**No significant difference was found between the citation rates of papers classified under Primary Finding and those classified under Primary Empirical Evidence.

2. graduate school attendance has more effect on a scientist's later productivity than current location
3. former students of eminent sponsors are more likely to be highly productive than students of other scientists.

Gillmor

In 1975, Gillmor²⁸ published a paper studying the citation characteristics of papers published in the Journal of Atmospheric and Terrestrial Physics (JATP). As part of that study he considered the frequency of citation of JATP articles and the JATP editorial assessment, the editors of JATP have constructed approximate categories, (α , β , γ) for papers accepted for publication in JATP. The editor rated each paper as follows:

α : Papers that report a valuable piece of work that will need to be read by all workers in the field that it covers. These papers will be widely quoted.

β : Papers that, although important, are on a very narrow topic. Although useful they will not be widely read.

γ : Papers in which there is nothing wrong but in which there is little of importance. They will be read only by a few.²⁹

An alternate evaluation, based on citations, utilized the discriminant function analysis method, comparing citation information with the editor's rating for 349 papers in the 1967 and 1968 JATP volumes. Table 6-16 shows the correspondence between the discriminant function and the computer-assigned rating of A, B or C to each paper. For the 349 papers published in 1967 and 1968, those rated α by the JATP editor had attained a mean of 18.1 citations by 1973; those rated β , a mean of 6.4 citation, and those rated γ a mean 3.0 citations. Gillmor concludes that

The analysis presented here suggests that the general readership would agree with editorial choice in the selection of papers most appropriate to publication in JATP.³⁰

²⁸C.S. Gillmor, "Citation Characteristics of the JATP Literature," Journal of Atmospheric and Terrestrial Physics 37 (November, 1975):1401-1404.

²⁹Ibid., p. 1403.

³⁰Ibid., p. 1404.

TABLE 5-16

ALTERNATIVE METHODS OF RATING JATP PAPERS
 FOR 1967-1968
 (from Gillmor, 1975)

JATP editor's rating	Discriminant function analysis rating utilizing citation data			
	A	B	C	
α	35	14	10	59
β	31	90	85	206
γ	1	19	64	84
	67	123	159	349 papers total

Harrold

In 1969, Harrold³¹ published an evaluation of measurable characteristics within Army laboratories. The object of his study was to identify indicators which would assist management in making overall decisions that would affect the productivity of the laboratories. The major problem was the identification of measurable characteristics. Two approaches were tried. The first was to interview managers at specific research installations to ascertain what, if any, measurable characteristics would be of assistance to them. The second approach was to select certain external criteria and determine if they were meaningful to management. The first approach turned out to be unsuccessful and Harrold fell back upon the external criteria. Two external standards were decided on: the number of papers and invention disclosures produced by a laboratory, and a laboratory performance rating by military R&D executives. The rating of the laboratory was based on "...how well a laboratory performed its mission..."³² as well as on staff and equipment, research environment, etc. Harrold concluded that there is very little relationship between laboratory performance and the number of papers or invention disclosures.

As the performance of an Army laboratory's mission is not necessarily related to the external publications of the laboratory, Harrold's conclusion is not surprising.

Harrold then tried a third approach. He isolated patent and invention disclosures, and considered laboratory performance based on a set of military and civilian characteristics of the laboratory. He found that the correlation of papers and invention disclosures with military personnel was minimal. Substituting civilian data he found that the only significant correlations of publications and disclosures were

- a. in-house R&D obligations, 0.69
- b. number of civilians doing graduate work, 0.69, and
- c. total number of civilian R&D professionals, 0.56.

Small

In 1974 Small³³ studied the characteristics of frequently cited papers in chemistry, in order to determine what a high citation rate indicates. One of the aims of the study was to

³¹Harrold, "An Evaluation of Measurable Characteristics Within Army Laboratories."

³²Ibid., p. 20.

³³Henry G. Small, Characteristics of Frequently Cited Papers in Chemistry, final report on contract number NSF-C795 (Philadelphia, Institute for Scientific Information, September 1974).

determine whether citation frequency is related to the perceived quality importance of papers.

The sample for the basic study consisted of 4,203 chemistry publications that were cited ten or more times in the 1972 SCI. These publications were divided into three ranges of citation frequency: 10-19 citations (81%), 20-30 citations (15%), and 40 + citations (5%). From this sample, a sub-sample of 61 papers was selected from the three ranges of citation frequency. In addition, 12 papers published in 1971 and cited fewer than three times in 1972 and 1973 were added to the sub-sample.

A group of judges was then selected from chemists who cited one of the 61 papers in the three ranges of citation frequency. Each judge received three papers to evaluate according to whether the quality was low, medium, or high. A chi-square test of responses indicated that the peer judgment of quality corresponded with citation frequency ($\chi^2 = 25.6$, with $p < .005$).

Virgo

In a 1974 doctoral dissertation at the University of Chicago, Virgo³⁴ studied citation rates and judges' ratings of papers in the medical literature. She used as judges a group of nine medical researchers who were actively engaged in the practice of clinical medicine, and in research in surgery and radiology. For each judge, a bibliography of articles published in his own specific field of research or clinical interest was developed from MEDLARS.

Citation frequency data were then collected for the relevant articles, based on the SCI, and the articles were ranked according to citation frequency. The top five articles and the bottom five articles in the ranking were selected. Pairs of articles were formed, one member from the frequently cited group and one member from the infrequently cited group. The extremes of the ranked lists were used to emphasize any differences between infrequently and frequently cited papers. Various randomization strategies (omission of authors, etc.) were used to avoid biasing the judges. After the judge evaluated each of his pairs, he was asked to name two people anywhere in the United States whom he considered to be doing outstanding work in the same research area. One of these two people was then sent the same set of articles and questionnaire. The analysis was structured so that, if there were no association between judging and citation frequency, the more frequently-cited pair member would be judged the more important in about one half the cases. If the association between impor-

³⁴Julie Virgo, "A Statistical Procedure for Evaluating the Importance of Scientific Papers," (PhD dissertation, University of Chicago, 1974).

tance and citedness was positive, then the proportion of times (p) that each method selected the same paper from a pair would be in the interval $0.5 \leq p \leq 1.0$.

Table 5-17 summarizes the results of this study. Not only did the citation frequencies independently agree with both judges, but the citation frequencies agreed with either of the judges more closely than the two judges agreed with each other. An additional interesting point was that the judges were able to guess, 90% of the time, which paper was the most highly cited. This figure is higher than the percentage of times they chose the more frequently cited paper as the more important.

Zuckerman

In 1967 Zuckerman³⁵ published a paper on patterns of productivity, collaboration and authorship for Nobel laureates in science. She studied the publication rates for matched pairs of Nobel laureates and for a sample of scientists in the same general fields drawn from American Men of Science. She found that the publication of Nobel laureates begins earlier and continues longer than for the matched sample. In addition the laureates publish at a much higher rate, with a median rate of 3.9 papers each year compared to 1.4 papers per year for the matched scientists. The most prolific laureate managed to publish 10 papers annually - one every five weeks - for more than 20 years. Only one laureate had published less than one paper annually, compared to 12 men in the control sample. The productivity of the Nobel laureates was greatest during their forties, when they averaged four papers a year, while their less eminent counterparts were most prolific during their thirties, with an average annual publication rate of 1.9 papers.

3. Studies Using Qualitative Measures

The next three papers contain qualitative data, but nevertheless, reinforce the positive relationship between bibliometric measures and other measures of importance.

Middleton

In 1974 Middleton³⁶ looked at the citation patterns of papers published in the Journal of Sedimentary Petrology. The journal publisher, the Society of Economic Paleontologists and Mineralogists selects a best or outstanding paper annually.

35

Harriet Zuckerman, "Nobel Laureates in Science: Patterns of Productivity, Collaboration, and Authorship," American Sociological Review 32 (1967):391-403.

36

Gerard V. Middleton, "Citation Patterns of Papers Published in the Journal of Sedimentary Petrology," Journal of Sedimentary Petrology 44 (March 1974):3-6.

TABLE 5-17

ASSOCIATION BETWEEN JUDGE RATINGS, CITATION
FREQUENCY, AND AGREEMENT BETWEEN JUDGES
(from Virgo, 1974)

No. of Judges in Sample	Column 1 Citation Frequency Agreeing with Judge Set 1		Column 2 Judge Set II Agreeing with Judge Set 1		Column 3 Citation Frequency Agreeing with Judge Set II	
	7	9	7	9	7	9
Is this article the more important to you in terms of your own research?	.721 (.076) ^a	.761 (.079)	.671 (.095)	.678 (.099)	.707 (.136)	.729 (.127)
Do you consider this article to be the more significant contribution to your subject area (as distinct from your own specific research work)?	.779 (.067)	.794 (.069)	.729 (.117)	.689 (.113)	.779 (.100)	.761 (.111)
Do you consider this article to be of more lasting importance in your field?	.798 (.054)	.831 (.057)	.705 (.085)	.715 (.081)	.735 (.128)	.750 (.121)
If you were an editor of a specialty journal would you choose this paper for republication in a wider, more visible medium in this subject area--						
a. In its present form?	.707 (.092)	.739 (.085)	.731 (.122)	.680 (.177)	.700 (.094)	.689 (.101)
b. If it were re-written for a broader audience but in this same subject specialty?	.695 (.083)	.730 (.086)	.640 (.085)	.631 (.075)	.705 (.106)	.715 (.099)
On a 5-point scale, with 1 being the lowest and 5 the highest, please rate this article using your comparative experience of the standards of published articles in this area generally.	.674 (.009)	.702 (.059)	.704 (.074)	.692 (.066)	.818 (.082)	.803 (.080)

*The figures in parentheses are the associated sample standard deviations for the averages in the table.

Middleton listed these papers, counted the number of citations to each of them, and suggested that the outstanding papers are cited at a rate substantially higher than other papers published in the same journal. Because of time lag and normalization problems, the quantitative significance of his data is not clear.

Mosaic

A recent article on criminology research, appearing in Mosaic,³⁷ considered the frequency of citation from 4,000 criminology works. The authors also examined the peer evaluations of a bibliography of 4,000 works sent to 500 researchers. They stated that

...the concordance between the citation rating and peer evaluation is 'truly amazing' especially as to the top five articles.³⁸ Three ranked in the top five of both groups.³⁸

Myers

In 1970 Myers³⁹ looked at journal citation and scientific eminence in psychology, to determine whether the frequency with which a psychologist is cited in the journal literature is a reliable and valid measure of his standing in the field of contemporary psychology. Myers used a sample of 14 journals over a six year period, with a sample size of 143,000 citations, discounting self-citation.

Establishing a basic level of visibility in psychology as six or more citations, he reduced the sample to 3,000 authors. These authors represented the top 6% of the population. They were then ranked in deciles, according to the number of citations they received.

The adequacy of the sample selection was checked in a number of ways, including use of other larger samples of journals, choice of eminent individuals by other psychologists, and choice of eminent individuals from American Men of Science.

The validity of the citation count was then tested, to determine the extent to which the citation count was a measure of scientific eminence. Ten different measures of eminence were used including listings in Modern Men of Science, positions in the American Psychological Association, awards, memberships,

³⁷"Criminology Research: How Good and How Useful?" Mosaic 7 (March/April 1975):15-17.

³⁸Ibid., p. 17.

³⁹Roger C. Myers, "Journal Citations and Scientific Eminence in Contemporary Psychology," American Psychologist 25 (1970):1041-1048.

and Cartter rank of schools.

In almost every case the highly cited scientists were also prominent in the various meritorious groups. Myers concluded that scientists judged to be scientifically eminent on the basis of a variety of independent criteria were also the most frequently cited.

VI. OPERATIONAL CONSIDERATIONS

A. Basics of Publication and Citation Analysis

The first section of this chapter discusses the major stages of publication and citation analysis techniques in evaluative bibliometrics. Later sections of the chapter consider publication and citation count parameters in further detail, including discussions of data bases, of field-dependent characteristics of the literature, and of some cautions and hazards in performing citation analyses for individual scientists.

The basic stages which must be kept in mind when doing a publication or citation analysis are briefly summarized in Figure 6-1.

1. Type of Publication

For a publication analysis the fundamental decision is which type of publication to count. A basic count will include all regular scientific articles. However, notes are often counted since some engineering and other journals often contain notes with significant technical content. Reviews may be included. Letters-to-the-editor must also be considered as a possible category for inclusion, since some important journals are sometimes classified as letter journals. For example, publications in Physical Review Letters were classified as letters by the Science Citation Index prior to 1970, although they are now classified as articles.

For most counts in the central core of the scientific literature, articles, notes and reviews are used as a measure of scientific output. When dealing with engineering fields, where many papers are presented at meetings accompanied by reprints and published proceedings, meeting presentations must also be considered. In some applied fields, i.e., agriculture, aerospace and nuclear engineering, where government support has been particularly comprehensive, the report literature may also be important. Unfortunately, reports generally contain few references, and citations to them are limited so they are not amenable to the normal citation analyses.

Books, of course, are a major type of publication, especially in the social sciences where they are often used instead of a series of journal articles. In bibliometrics a weighting of n articles equal to one book is frequently used; no uniformly acceptable value of n is available. A few of the papers discussed in Chapter V contain such measures.

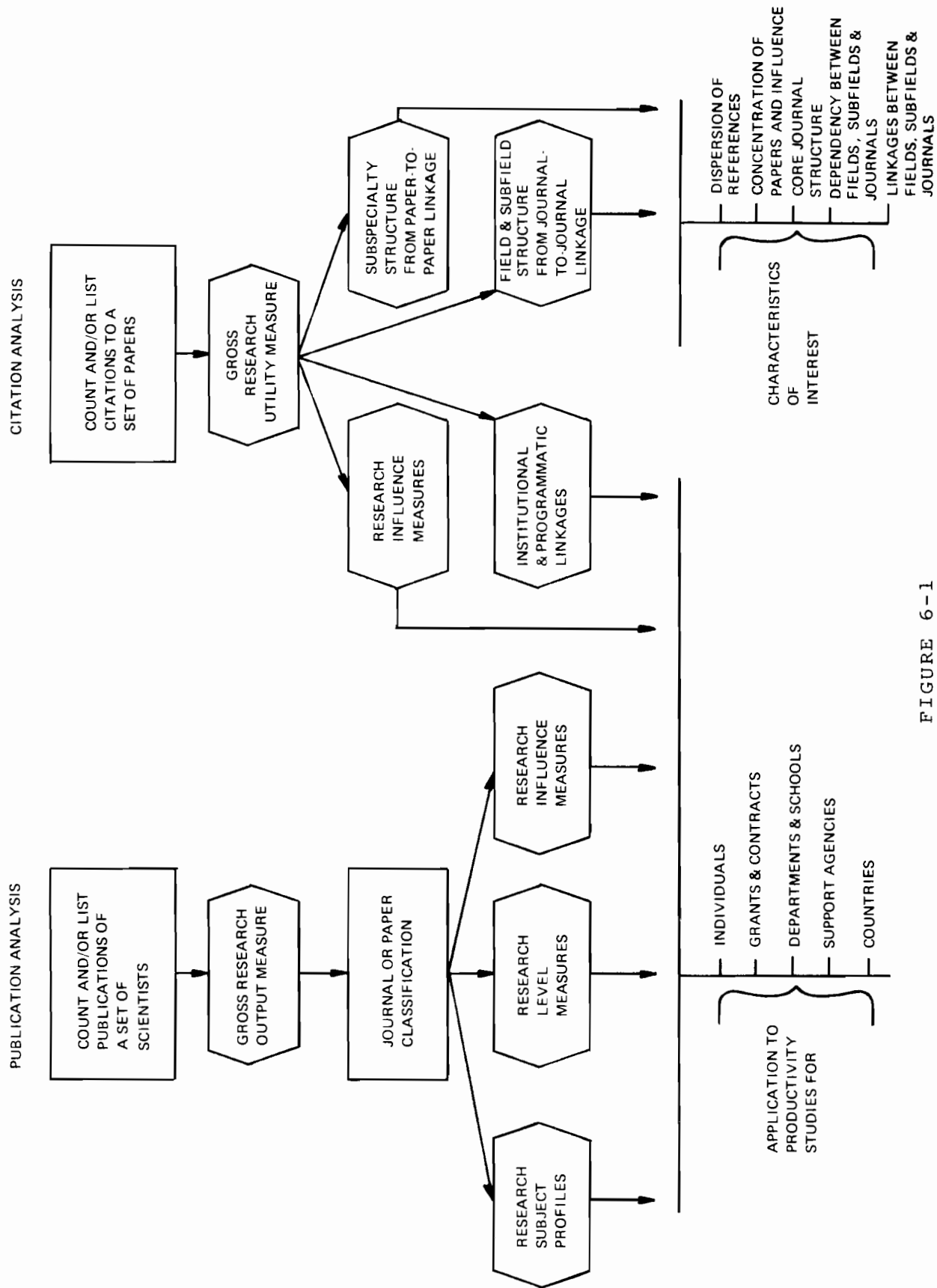

FIGURE 6-1

STAGES OF PUBLICATION AND CITATION ANALYSIS

2. Time Spans

A second important decision in making a publication count is to select the time span of interest. In the analysis of the publications of an institution a fixed time span, usually one year or more, is most appropriate. In comparing publication histories of groups of scientists, their professional ages (normally defined as years since attaining the PhD degree) must be comparable so that the build-up of publications at the beginning of a career or the decline at the end will not complicate the results. A typical scientist's first publication appears soon after his dissertation; if he continued working as a scientist, his publications may continue for thirty or more years.

The accurate control of the time span of a count is not as trivial as it might seem. Normally, the publication count is made from secondary sources (abstracting or indexing services) rather than from scanning the publications individually. Since most abstracting and indexing sources have been expanding their coverage over time, any publication count covering more than a few years must give careful consideration to changes in coverage. Furthermore, the timeliness of the secondary sources varies widely, with sources dependent on outside abstractors lagging months or even years behind. Since these abstracting lags may depend upon language, field and country of origin, they are a particular problem in international publication counts.

The Science Citation Index is one of the most current secondary sources, with some 80% to 90% of a given year's publications in the SCI for that year.

Of course, no abstracting or indexing service can be perfect, since some journals are actually published months after their listed publication dates. Nevertheless, variations in timeliness are large from one service to another.

3. Comprehensiveness of Source Coverage

An important consideration in making a publication count is the comprehensiveness of the source coverage. Most abstracting and indexing sources cover some journals completely, cover other journals selectively, and omit some journals in their field of interest. The Science Citation Index is an exception in that it indexes each and every important entry from any journal it covers. This is one of the major advantages in using the SCI as a data base. Chemical Abstracts and Biological Abstracts have a group of journals which they abstract completely, coupled with a much larger set of journals from which they abstract selectively, based upon the appropriateness of the article to the subject coverage. In some cases the abstractor or indexer may make a quality judgment, based on his estimate of the importance or the quality of the article or upon his

knowledge of whether similar information has appeared elsewhere; Excerpta Medica is a comprehensive abstracting service for which articles are included only if they meet the indexers' quality criteria.

Some data on the extent of coverage of the major secondary sources is presented in Section D of this chapter.

4. Multiple Authorships and Affiliations

Attributing credits for multiple authorships and affiliations is a significant problem in publication and citation analysis. In some scientific papers the authors are listed alphabetically; in others the first author is the primary author; still others use different conventions. These conventions have been discussed by Crane¹ and by other social scientists.² There does not seem to be any reasonable way to deal with the attribution problem, except to attribute a fraction of a publication to each of the authors. For example, an article which has three authors would have one-third of an article attributed to each author. The amount of multiple authorship unfortunately differs from country to country and from field to field. Several studies have investigated the problem, but no comprehensive data exists.³

Multiple authorship takes on particular importance when counting an individual's publications since membership on a large research team may lead to a single scientist being a co-author of ten or more publications per year. This number of publications is far in excess of the normal publication rate of one to two articles per year per scientist.

Multiple authorship problems arise less often in institutional publication counts since there are seldom more than one or two institutions involved in one publication.

A particularly vexing aspect of multiple authorship is the first author citation problem: almost all citations are to the first author in a multi-authored publication. As a result, a researcher who is second author of five papers may receive no

¹Diana Crane, "Social Structure in a Group of Scientists: A Test of the 'Invisible College' Hypothesis," American Sociological Review 34 (June 1969):335-352.

²James E. McCauly, "Multiple Authorship," Science 141 (August 1963):579.

Beverly L. Clark, "Multiple Authorship Trends in Scientific Papers," Science 143 (February 1964):822-824.

³Harriet Zuckerman, "Nobel Laureates in Science: Patterns of Productivity, Collaboration, and Authorship," American Sociological Review 32 (June 1967):391-403.

citations under his own name, even though the papers he co-authored may be highly cited. Because of this, a citation count for a person must account for the citations which appear under the names of the first authors of publications for which the author of interest was a secondary author. This can lead to a substantial amount of tedious additional work, since a list of first authors must be generated for all of the subjects' multi-authored papers. Citations to each of these first authors must then be found, the citations of interest noted, and these citations fractionally attributed to the original author. Since multiple years of the Citation Index are often involved, the amount of clerical work searching from volume to volume and from author to author, and citation to citation can be quite large.

A note of caution about the handling of multiple authorship in the Corporate Index of the Science Citation Index: SCI lists a publication giving all the corporate affiliations, but always with the first author's name. Thus a publication by Jones and Smith where Jones is at Harvard and Smith is at Yale would be listed in the Corporate Index under Harvard with the name Jones and also under Yale with the name Jones. To find the organization with which the various authors are affiliated, the original article must be obtained.

Although the publisher of the Science Citation Index, the Institute for Scientific Information, tries to maintain a consistent policy in attributing institutional affiliations, when authors have multiple affiliations the number of possible variants is large. In the SCI data base on magnetic tape, sufficient information is included to assign a publication with authors from a number of different institutions in a reasonably fair way to those institutions; however, in the printed Corporate Index, one has to refer to the Source Index to find the actual number of authors, or to the paper itself to find the affiliations of each of the authors.

5. Completeness of Available Data

Another consideration in a publication analysis is the completeness of data available in the secondary source, since looking up hundreds or thousands of publications individually is tedious and expensive. One difficulty here is that most of the abstracting and indexing sources are designed for retrieval and not for analysis. As a result, some of the parameters which are of greatest analytical importance, such as the affiliation of the author and his source of financial support, are often omitted. Furthermore, some of the abstracting sources are cross-indexed in complex ways, so that a publication may only be partially described at any one point, and reference must be made to a companion volume to find even such essential data as the author's name. While intellectually trivial, these

searches can be exceedingly time consuming when analyzing large numbers of publications.

The specific data which are consistently available in the secondary sources are the basic bibliographic information: i.e., authors' name, journal or report title, volume, page, etc. This information is the basic data used for retrieval, and since the abstracting and indexing services are retrieval oriented, this bibliographic information is always included.

Data which are less consistently available in the secondary source are the authors' affiliation and the authors' rank or title. Both of these are of interest in analysis. For example, the ranking of universities based on publication in a given subject area is often of interest. This ranking can be tabulated only from a secondary source which gives the authors' university affiliation.

6. Support Acknowledgements

The source of the authors' financial support is seldom given in any secondary source, although it is now being added to the MEDLARS data base. Since this financial data can be used to define the fraction of a subject literature which is being supported by a particular corporate body such as a governmental agency, the data are of substantial evaluative interest.

The amount of acknowledgement of agency support in the scientific literature has changed over time. In a Computer Horizons study completed in 1973 the amount of agency support acknowledgement was tabulated in twenty major journals from five different fields.⁴ Table 6-1 summarizes those support acknowledgements for 1969 and 1972.

In 1969, only 67% of the articles in 20 major journals acknowledged financial support. By 1972, the percentage of articles acknowledging financial support had risen to approximately 85%. The table shows that the sources of support differ from one field to another and also shows that the fields of interest to these sources differ as well. For example, the National Science Foundation is the major source of acknowledged support in mathematics, while the National Institutes of Health clearly dominate the support of biology. Chemistry is the field with the largest amount of non-government (private sector) support in the U.S.

Note also that the 20 journals used were major journals in their fields; as less prestigious journals are examined, the amount of support acknowledgement generally decreases.

⁴ Computer Horizons, Inc., Evaluation of Research in the Physical Sciences Based on Publications and Citations, Washington, D.C., National Science Foundation, Contract No. NSF-C627, November, 1973.

TABLE 6-1

AGENCY SUPPORT ACKNOWLEDGEMENTS IN 20 LEADING JOURNALS
FROM 5 MAJOR FIELDS - 1969 and 1972

Agency Acknowledged	Mathematics		Physics		Chemistry		Biochemistry		Biology		All Fields	
	1969	1972	1969	1972	1969	1972	1969	1972	1969	1972	1969	1972
NSF	18%	37%	14%	19%	18%	21%	8%	8%	8%	8%	13%	16%
NIH	2	1	1	1	11	10	37	39	23	32	13	16
AEC	1	1	21	15	10	8	3	2	3	2	11	8
DOD	15	7	19	15	10	10	1	1	2	3	10	9
NASA	1	1	7	9	2	2	1	1	1	2	3	4
Other U.S. Government	1	2	1	2	2	2	1	1	1	3	1	2
Other U.S.	3	10	3	14	8	21	10	10	9	13	7	14
Foreign	5	4	5	15	7	8	16	25	10	24	8	16
Unacknowledged	55	37	31	11	32	18	25	13	42	14	33	15

In an attempt to account for the 15% of unacknowledged papers, a questionnaire was sent to all U.S. authors in the 1972 sample who did not acknowledge agency support. Almost 70% of the authors who had not listed sources of support responded to the questionnaire. Of the authors who responded, over two-thirds were supported by their institutions as part of their regular duties; approximately 20% of the respondents cited specific governmental agencies as sources of support, even though they had not acknowledged these in the article itself. Twelve percent of the respondents listed no agency or institutional support; research done as fulfillment of graduate studies was included in this category.

Overall, the 1972 tabulation and survey showed that 88% of the research reported in these prestigious journals was externally supported, and that 97% of the externally supported work was acknowledged as such.

7. Subject Classification

Having constructed a basic list of publications, the next step in analysis is normally to subject classify the publications. Either the journals or the papers themselves may be classified. When a large number of papers is to be analyzed, classification of the papers by the field of the journal can be very convenient. Such a classification implies, of course, a degree of homogeneity of publication which is normally adequate when analyzing hundreds of papers. Such a classification may not be sufficient for the analysis of the scientific publications of one or a few individuals.

Subject classification schemes differ from one abstracting and indexing service to another. Therefore, a comparison of a collection of papers based on the classification schemes of more than one abstracting and indexing service is almost hopeless. A classification of papers at the journal level has been used in the influence methodology discussed in Chapters VII through X.

8. Citation Counts

Citation counts are a tool in evaluative bibliometrics second in importance only to the counting and classification of publications. Citation counts may be used directly as a measure of the utilization or influence of a single publication or of all the publications of an individual, a grant, contract, department, university, funding agency or country. Citation counts may be used to link individuals, institutions, and programs, since they show how one publication relates to another publication.

In addition to these evaluative uses, citations also have important bibliometric uses, since the references from one paper to another define the structure of the scientific literature. Chapter III discusses how this type of analysis may be carried out at a detailed, micro-level to define closely related papers through bibliographic coupling and co-citation. That chapter also describes how citation analysis may be used at a macro-level to link fields and subfields through journal-to-journal mapping. The bibliometric characteristics of the literature also provide a numeric base against which evaluative parameters may be normalized.

Some of the characteristics of the literature which are revealed by citation analysis are noted on Figure 6-1. These characteristics include:

The dispersion of references: a measure of scientific "hardness", since in fields that are structured and have a central core of accepted knowledge, literature references tend to be quite concentrated.

The concentration of papers and influence: another measure of centrality in a field, dependent upon whether or not a field has a core journal structure.

The hierarchic dependency relationships between field, subfield and journals, including the comparison of numbers of references from field A to field B, compared with number of references from field B to field A: this comparison provides a major justification for the pursuit of basic research as a foundation of knowledge utilized by more applied areas.

The linkages between fields, subfields and journals: a measure of the flow of information, and of the importance of one sector of the scientific mosaic to another.

B. An Example of an Evaluative Bibliometric Analysis

To illustrate many of the steps involved in a typical evaluative bibliometric analysis, a Computer Horizons study of U.S. biomedical publications will be used. The overall study was aimed at evaluating many different aspects of the linkages between biomedical research publications and the National Institutes of Health (NIH) funding. The section of the study described here is an inquiry into the direct relationship between NIH funding and the number of biomedical publications produced by major U.S. biomedical research institutions.

1. Selection of Institutions

In FY 1972 approximately 750 American institutions received biomedical research support from the NIH. The great majority of these recipient institutions received only a small share of the total funding because of their small size and limited research capability, or because of their peripheral interest in biomedical research. To reduce the recipient institutions to a manageable number, the criterion for inclusion of institutions adopted was NIH grant funding of at least \$500,000 in at least one fiscal year during the period FY 1965-1972.

This criterion was met by 241 institutions. The 241 institutions accounted for between 89% and 94% of total NIH research funding in the individual years between 1965 and 1972.

In assessing the funding and publication data, it became apparent that the 241 institutions would have to undergo further winnowing. This winnowing was necessary because the creation of some new institutions well into the FY 1965-1972 period meant that insufficient publication data existed for them. Also in the winnowing process, several institutions were dropped because their publications were unidentifiable in the SCI tapes.

A further alteration in the structure of the data base was imposed to account for institutional distinctions which occurred in the funding classification, but which did not appear clearly in the publication data. For example, in the funding data, the Population Council and Rockefeller University appear as distinct institutions. However, in the publication data set they are indistinguishable. In order to unify the data so that the funding and publication figures are congruent, the Population Council and Rockefeller University were treated as a single institution. Similarly, the St. Paul and Minneapolis campuses of the University of Minnesota are considered as one.

In the end, 229 institutions constituted the core publication and funding data base. Additional variations occurred in response to demands placed on the data. For example, University of California and State University of New York figures were dropped on those occasions when the analysis called for information on individual schools.

2. Collecting Data on NIH Grants

The major difficulty in collecting data on NIH grants stems from the fact that NIH has undergone many organizational shifts in the past decade. For example, the National Institute of Mental Health (NIMH) was an institute in NIH prior to 1967. After that date it was transferred out of NIH, only to be brought back into the fold again six years later. But the reunion was

to be short-lived. After reinclusion into the NIH family for a few months, NIMH once again left NIH to become part of the Alcohol, Drug Abuse, and Mental Health Administration (ADAMHA). Clearly, such organizational changes must be taken into account so as to minimize their impact on the analysis.

In addition, the NIH/Public Health Service (PHS) relationship has changed. Prior to FY 1969, the overall character of the PHS was similar to that of NIH today. Over 90% of the grant funding made by the PHS as a whole was roughly comparable to current NIH funding. After FY 1969 the character of the PHS changed substantially with the creation of Health Services and Mental Health Administration (HSMHA) and the Environmental Health Service as distinct agencies, and the addition of the Food and Drug Administration to the PHS's charge. Thus PHS funding prior to FY 1969 was taken as an approximation of what NIH funding would have been if measured by 1973 standards. In the analysis, NIMH funding is treated separately from NIH funding, so that the six year hiatus with NIMH outside NIH offers no analytical problem.

3. Use of R&D Price Deflator

In their publication, "A Price Index for Deflation of Academic R&D Expenditures", NSF 72-310,⁵ the National Science Foundation (NSF) notes that the cost of scientific R&D is rising at a faster rate than inflation as measured by the Consumer Price Index. Research dollars received by researchers buy less and less with the passage of time. This cheapening of the research dollar was taken into account in assessing the impact of biomedical funding on research productivity.

4. Concentration of Funding

One interesting question that arises in an analysis of NIH research funding patterns is: with the passage of time, are funds being more concentrated in the hands of a few recipients or less concentrated? Lorenz curve analysis provides an answer to this question.

The Lorenz curve is an analytical tool occasionally used in economics to measure the distribution of wealth and income in a population. It is simply a plot of the percent of a population associated with given percentages of income or wealth.

The Lorenz curve is illustrated in Figure 6-2. The pictured diagonal represents the situation that occurs when each X_i percent of the population receives exactly X_i percent of the national income for all X_i , where $0 \leq X_i \leq 100$. It can be viewed as a line of perfect equality of the distribution of income among members of the country's population.

⁵National Science Foundation, A Price Index of Academic R&D Expenditures, Washington, D.C.: U.S. Government Printing Office, May, 1972.

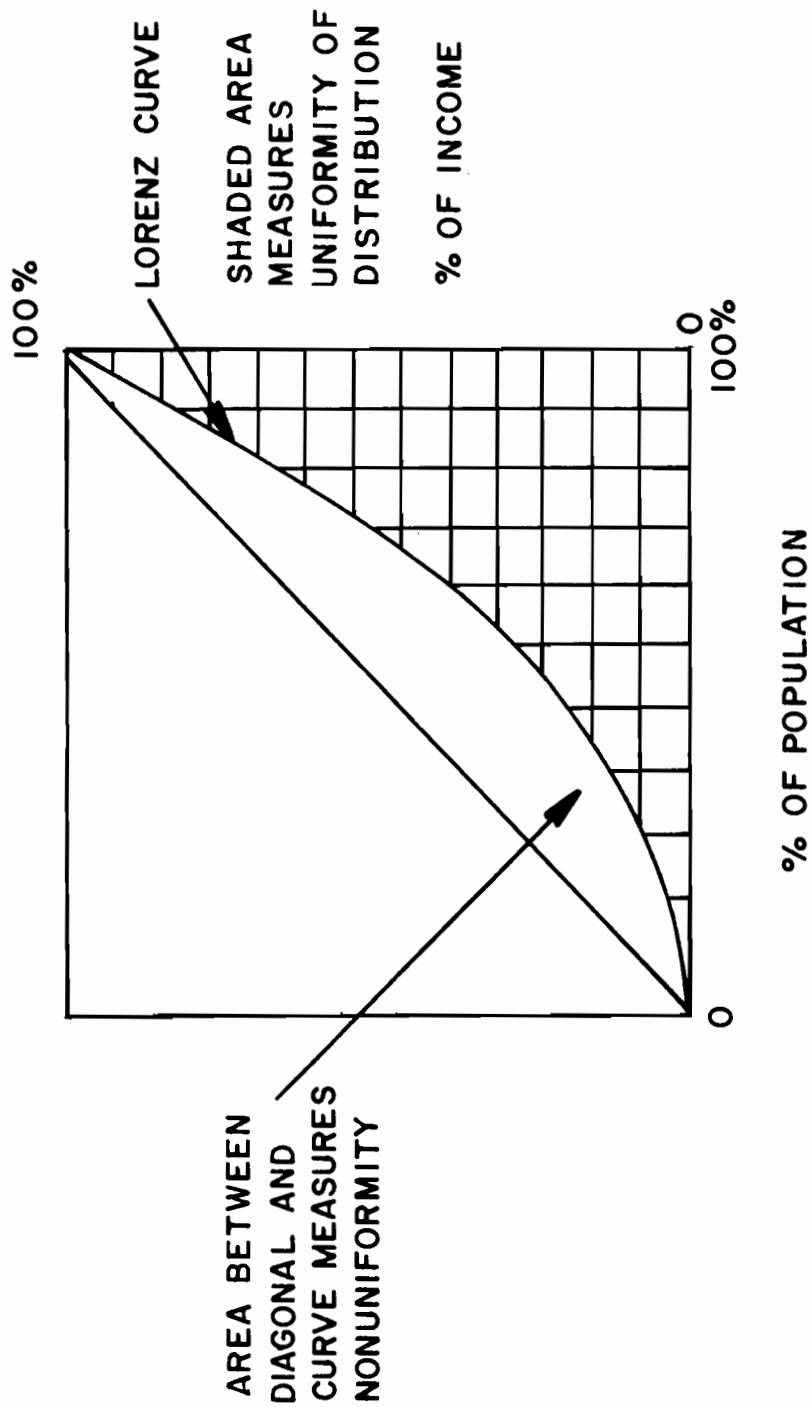

FIGURE 6-2

LORENZ CURVE

The greater the deviation of the plotted Lorenz curve from the diagonal, the greater the extent of nonuniformity that is pictured. This suggests a numerical index of uniformity of the distribution. Consider the shaded area lying between the Lorenz curve and the axes. The greater the extent of nonuniformity pictured, the smaller this area. As nonuniformity diminishes, the area increases. The Gini index (GI)⁶ is a measure based on this area. It can be calculated as follows:

$$GI = 1 - 2 \times (\text{area under curve}).$$

The resulting index ranges from zero for perfectly uniform distribution to one for complete concentration. Figure 6-3 shows the Lorenz curve for NIH funding awarded to 226 institutions in 1972.

By comparing the Gini index for NIH funding from one year to the next, trends can be detected in the extent to which funding is or is not becoming increasingly concentrated in the hands of a few institutions. The data show that for 1965-1972, funding patterns remained quite stable. As a perusal of Table 6-2 demonstrates, the Gini index reached a minimum value in 1966 (0.555) and a maximum value in 1972 (0.579). There appears to be a gradual increase in the concentration of funding to the institutions over time. However, the increase is so small as to seem of little significance from a policy standpoint.

TABLE 6-2

CHANGES IN NIH FUNDING CONCENTRATION

Year	1965	1966	1967	1968	1969	1970	1971	1972
Gini Index	.563	.555	.559	.559	.559	.561	.572	.579

5. Non-NIH Funding

NIH is by far the single largest source of U.S. biomedical research funding. Other federal sources of extramural funding are the National Science Foundation (NSF), the National Aeronautics and Space Administration (NASA), the Atomic Energy Commission (AEC), the Department of Defense (DOD), and the Veterans Administration (VA). In addition to federal biomedical research support, there is a small but not insignificant amount of funding emanating from private non-profit foundations. The

⁶Hayward R. Alker, Jr., Mathematics and Politics, New York: The Macmillan Company, 1965.

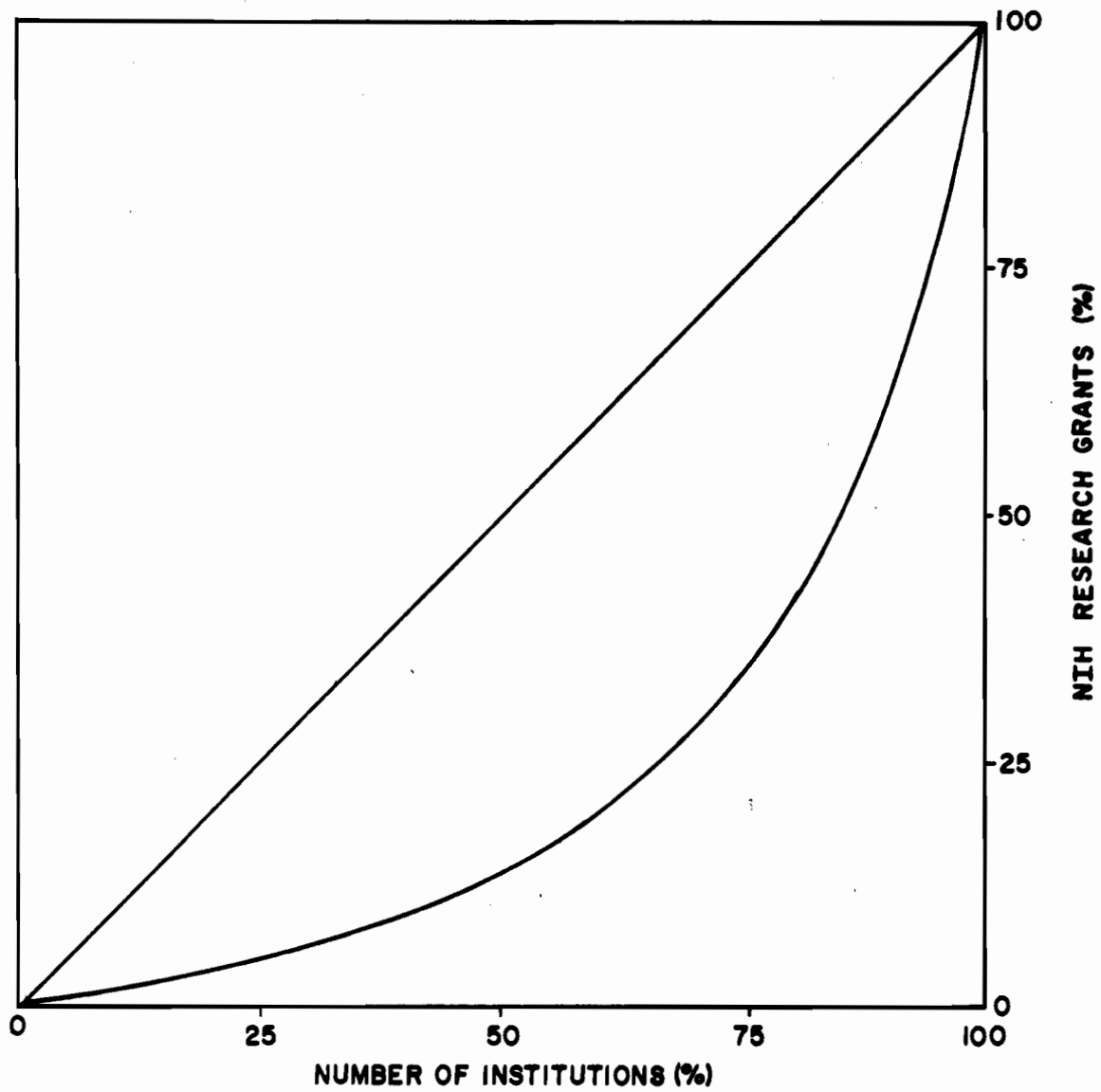

FIGURE 6-3

LORENZ CURVE FOR NIH FUNDING TO 226
RECIPIENT INSTITUTIONS IN 1972

major foundations which support biomedical research include: the American Heart Association, the National Foundation, the United Cerebral Palsy Association, the American Lung Association, the National Society for the Prevention of Blindness, the Muscular Dystrophy Association of America, the National Hemophilia Association, the National Easter Seal Society, the Allergy Foundation of America, the Arthritis Foundation, the American Cancer Society, and the American Diabetes Association.

The record of maintaining clean, reliable, and accessible data on biomedical research for non-NIH agencies has been irregular. In an effort to add an element of uniformity to the reporting of grants data in the late sixties, the Committee on Academic Science and Engineering (CASE) of the Federal Council for Science and Technology laid down guidelines for the reporting of research and development (R&D) grants data in the sciences. The different agencies were given a timetable by which they were to adjust their grant reporting systems until they were all parallel. Unfortunately, uniform data on R&D funding did not begin to appear until 1970. Prior to that date, the funding data for a number of agencies are inaccessible or generally useless for analytical purposes.

Once the CASE data reporting system took effect, data collection for the researcher became very easy. The data are broken down according to a number of fields (e.g., atmospheric science, oceanography, clinical medicine) and according to whether grants go to basic research, applied research, development, etc. Data for NASA, AEC, and NSF have been collected for 1970-1972.

The major problem with these data is that they contain grants awarded to the life sciences in general, which include zoology, agronomy, oceanography, etc., as well as grants awarded to fields which are more germane to human health. Those grants which are not health related were deleted before using these data.

Private foundations and non-profit health agencies offer substantial amounts of research support. Data on their grant awards were obtained from the annual reports issued by the foundations and agencies.

In all cases, only basic and applied research data were collected. Funding for the development of hardware was ignored, since it seems unlikely that such hardware development would find its way into the biomedical literature; also, most hardware development in non-NIH agencies is only remotely related to biomedicine.

A tabulation of this data is contained in Table 6-3.

TABLE 6-3

TOTAL BIOMEDICAL RESEARCH FUNDING BY FEDERAL
AND PRIVATE AGENCIES TO 229 INSTITUTIONS
(Average Figures for FY 1971 and FY 1972
combined. Thousands of Current Dollars)

NIH	NSF	NASA	AEC	DOD	PRIVATE SECTOR
\$684,925	\$31,208	\$7,756	\$25,064	\$4,051	\$15,527

The most interesting observation to be made about these figures is that NIH appears to play a much larger role in the support of biomedical research than had previously been recognized. More than 89% of the total extramural biomedical funding is associated with NIH grants support. Ninety-one percent (91%) of federal extramural biomedical research support is accounted for by NIH.

6. Data Base for Publications

The source of publication data for the study was the SCI's Corporate Index, which covered 2,788,451 records for the eight years 1965 through 1972. Each record on the Corporate Tape consists of a journal name, year of publication, volume and page numbers, first author's name, corporate (institution) name, type of publication code (article, letter, note, review, meeting, etc.), and a unique identifying number for each publication entry.

Multi-authored papers present a special problem that is easily resolved. These papers have as many records as coauthors in the Corporate Tape. Thus a paper written by three authors is listed three times in the Corporate Index. In order to account for multiple authorships, a first step in the processing was to sort the eight years' tapes separately according to the publication identifying number. Each of the identically numbered n records were assigned the value 1/n so that multi-authored papers would be equal in weight with single or other multi-authored papers. In addition, dividing a single n-authored paper into n parts enables credit to be assigned to different institutions when coauthors are affiliated with more than one institution.

7. Use of Fixed Journal Set

In 1972 the number of biomedical journals covered by the SCI was approximately 925. In 1965 roughly 500 biomedical journals were covered by the Corporate Index. The net gain in biomedical journal coverage between 1965 and 1972 was greater than 400 journals. The rapid growth in coverage raises the question of which journals should be included in the study.

After counting the individual publications in the journals for 1965-1972, it was determined that the 500 journals (called the fixed journal set, or FJS) contained 89.5% of the publications in the 925 journal set (called the variable journal set, or VJS). Specifically, there were 234,500 publications from the 241 original institutions of interest in the VJS, and 208,300 publications from the institutions in the FJS. Clearly, for the time period under consideration there is only a small discrepancy between the coverage of the FJS and VJS. In essence, all the large biomedical journals were in the FJS. The difference between the FJS and VJS coverage is chiefly smaller peripheral journals and new journals added since 1965.

Because working with a changing data set would require much additional statistical manipulation, and because it is unlikely that the additional 10% of publications would alter the overall findings significantly, it was decided to work only with the FJS.

8. Data Processing

All of the processing of the Corporate Tapes was done on large scale IBM computers. Following the initial sort described above, the eight years' tapes were individually resorted according to corporate name, and then merged into one 7 1/2 reel file, so that specific corporate names for all years would be placed together alphabetically. In order to identify and select the publications from the specific institutions required for the study, the merged tapes were put through a program which grouped together all records with the identical first 16 characters in the corporate name. (For example, consider CORNELL UNIV, DEPT ANAT. All corporate titles that contain the letters CORNELL UNIV, DE are grouped together and treated as part of Cornell University). From this both a printed listing of groups and a series of shorter tapes were obtained containing a journal number, article type identification code, publication year, weighting factor, group number, and other numbers used for location identification. The printed list of groups was approximately 300,000 lines long, reflecting a 10:1 overall grouping factor. Figure 6-4 is a retyped section of this 300,000 line list.

Group #	# in Group*	First Corporate Name in Group
24146	1	BOSTON COLL BOSTON
24147	1	BOSTON COLL CANC RES INST, CHESTNUT H
24148	14	BOSTON COLL CHESTNUT HILL
24149	25	BOSTON COLL DEP BIOL
24150	2	BOSTON COLL GRAD SCH SCC WORK BOSTON
24151	6	BOSTON COLL PHYS DEP CHESTNUT HILL
24152	244	BOSTON COLL SCH ED
24153	7	BOSTON COLLABORAT DRUG SERVEILL PROGRAM, WALTHAM
24154	4	BOSTON COLLEGE, BOSTON, MA
24155	1	BOSTON CONSULTING GRP INC, BOSTON, MA
24156	31	BOSTON CY HOSP, BOSTON, MA
24157	1	BOSTON DEP BIOL BOSTON
24158	1	BOSTON DEP HEALTH HOSP COMM HEALTH SE
24159	1	BOSTON DEPT HLTH & HOSP, BOSTON, MA 02118
24160	3	BOSTON DISPENSARY, DEPT DERMATOL & SYP
4161	1	BOSTON EAR NOSE & THROAT ASSOC INC, BO
24162	2	BOSTON EDIS CO
24163	3	BOSTON EDIS CO BOSTON
24164	1	BOSTON EDIS CO HYDR PARK
24165	10	BOSTON EDISON CO, BOSTON, MA
24166	1	BOSTON FED RESIDENTS & INTERNS, CAMBR
24167	50	BOSTON FLOATING HOSP BOSTON
24168	3	BOSTON GAS CO BOSTON
24169	1	BOSTON GEN HOSP, BOSTON, LINCS, ENGLA
24170	11	BOSTON GLOBE, BOSTON, MA
24171	1	BOSTON HEAD START PROGRAM
24172	1	BOSTON HOSP PARKW DIV BROCKLINE
24173	147	BOSTON HOSP WOMEN
24174	1	BOSTON I CANCER RES GLASGOW
24175	1	BOSTON JUVENILE COURT CLIN, BOSTON, M
24176	1	BOSTON LATIN SCH, BOSTON, MA
24177	1	BOSTON LEGAL AID SOC, BOSTON, MA
24178	6	BOSTON LYING IN HOSP
24179	2	BOSTON LYING-IN HOSP, DEPT PATHOL, BOS
24180	5	BOSTON MED LAB INC WALTHAM
24181	1	BOSTON MED LIBRAR SERV

*No. of publications with identical first 16 letters of corporate affiliation.

FIGURE 6-4
SAMPLE OF GROUPED CORPORATE LISTS

The next step in the process of extracting the relevant records was to identify the groups in which these desired records were located. This was done by hand from the printed output of groups obtained in the previous step. Inevitably, some of the records such as CHILDRENS HOSP D and UNIV CALIFORNIA were too well grouped and had to be expanded, listed by the original individual corporate name, and located according to subgroups. Other problems arising at this point involved changes in the way corporate names were abbreviated during the eight year period. During the early years of 1965 through 1969, the corporate name was short and hence contained little information (e.g., U CAL) whereas in later years more specific information was included--such as UNIV CALIFORNIA, DIV ORTHOPAEDIC, IRVINE, CA92664.

Once the relevant publications were identified by group, the type of publication was identified (only articles, letters, notes, and reviews were extracted), and the journal was checked to see that it was in the FJS biomedical set. If a record passed the selection criteria it was assigned to the publication set for its institution.

9. Publication Data Problems

In the course of processing and refining the publication data a number of problems affected the make-up of the final data. These major problems centered on the matter of identifying publications by institutional source.

Two particularly troublesome sets of institutions are those associated with the State University of New York (SUNY) and the University of California. The titles of these institutions are so long that ISI was unable to give a complete accounting of the corporate address in the limited space available for corporate identification. Consequently, while a publication may have been generated by the University of California, it may not be possible to specify the particular campus of origin (e.g., Berkeley, Davis, Irvine, etc.). Beginning with 1973, ISI assigned considerably more space in its system for corporate identification, so that this problem will be minimized in the future. This particular problem was handled by simply aggregating all SUNY and University of California publications into two super-institutions which were labeled SUNY and U CAL.

A second problem revolves around the fact that the publications of some clinical facilities associated with universities are not always included in the data base. This problem arises because of the difficulty inherent in matching some clinical facilities with particular universities. The most obvious cases have been accounted for in the data. Thus, Flower and Fifth Avenue Hospitals are treated as part of the New York Medical College. But what should be done in the case of a facility like

Boston City Hospital, which serves as a clinical facility for each of the three medical schools in the Boston Area? In the study, this problem was resolved by treating Boston City Hospital as a research institution in its own right.

10. NIH Funds vs. Publication Output: A Cross-Sectional View

Figure 6-5 graphically portrays the relationship between NIH funding and biomedical research output as these two variables relate to 133 universities. The vertical axis measures the average number of publications produced by the universities in 1968-1972, while the horizontal axis registers average NIH funding of the schools in FY 1965-1969, with funds measured in constant 1967 dollars. Funds and publications were averaged in this manner to reduce the impact of spurious annual fluctuations in university funding and publication output. In addition, the consideration of several years' funding associated with several years' publication output takes into account some of the publication lag effects. Informal analyses of the funding-publication relationship were conducted for individual years, with essentially identical results to those presented here.

The most striking feature of Figure 6-5 is the high degree of linearity displayed by the data. The equation of the regression line associated with the data is

$$Y = 15.75 + 0.0457X,$$

where Y is publication output and X is thousands of NIH dollars. The linear correlation coefficient for the data is $r = 0.95$. Both the intercept value and the slope coefficient were tested using the t statistic and were found to be significantly greater than zero at the .05 level ($t = 2.7752$ and $t = 34.7926$ respectively), and the Durbin-Watson statistic is $D = 1.9282$, which indicates the absence of autocorrelation.

What does this linear relationship mean? It appears that on the whole large institutions and moderate sized institutions behave in a similar fashion in utilizing funds to produce research output.* The slope coefficient indicates that, in the case of universities, an output of 4.57 publications is typically associated with increased funding levels of \$100,000. (Another way to look at it would be to say that on the average each publication "costs" roughly \$22,000). This does not mean that if NIH suddenly gave a moderate sized school \$10,000,000 that this school would publish 457 articles in three years' time. In a frictionless world this result might in fact occur, assuming that the university could adjust instantaneously to

*Recall that only institutions receiving at least \$500,000 from NIH in FY 1965-1972 were included in the study. Thus small institutions were systematically excluded from the data base. Consequently, this indicates nothing about the funding-publication behavior of small schools in contrast to moderate and large sized ones.

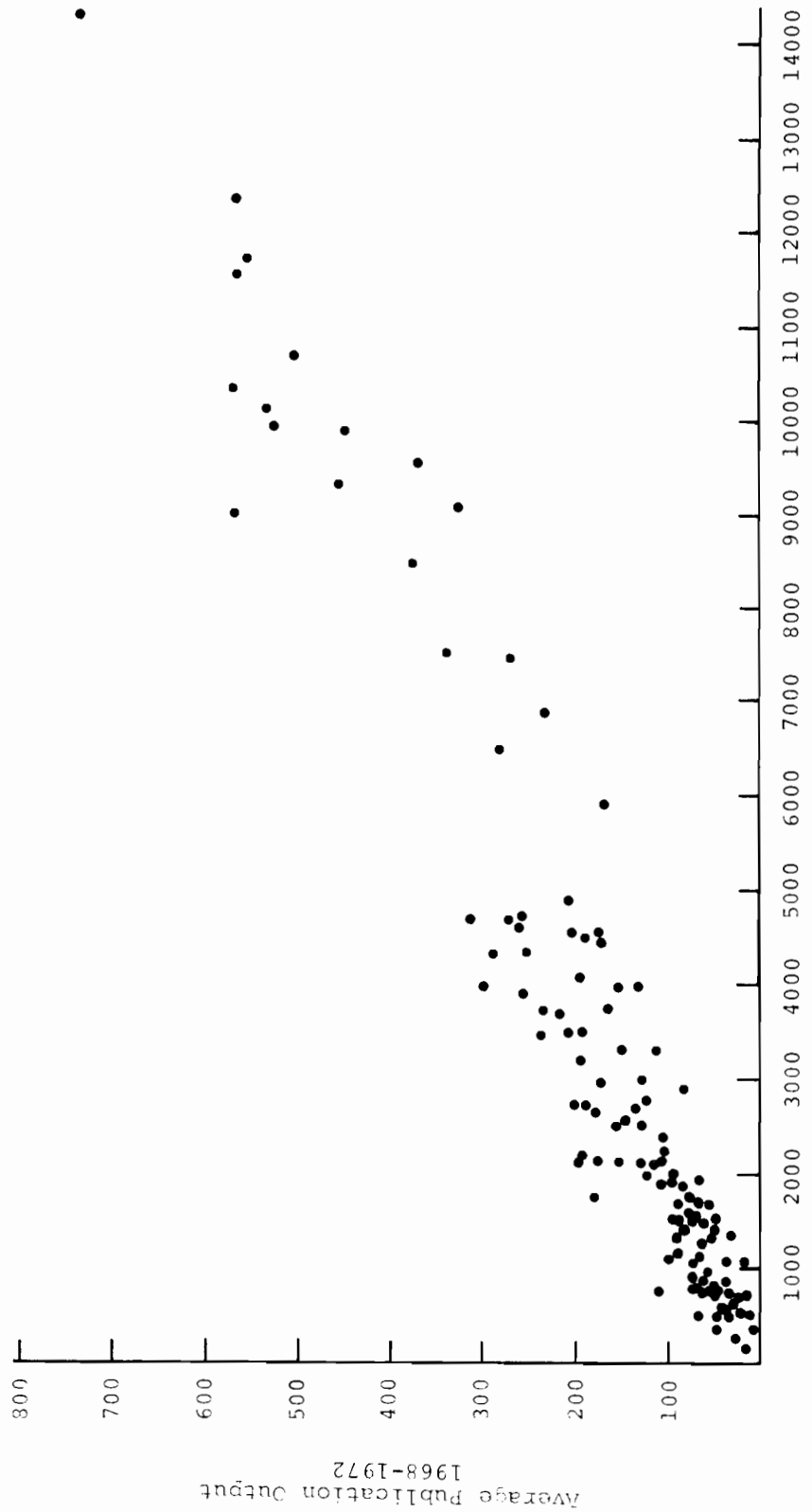

Average NIH Constant 1967 Dollars (thousands), 1965-1969

FIGURE 6-5
PUBLICATION OUTPUT VS. NIH FUNDS FOR 133 UNIVERSITIES

the influx of new funds (i.e., hire new researchers, purchase new equipment, expand facilities); but in the real world the likelihood is that the moderate sized recipient of such a large sum would have difficulty in absorbing so much money. Without doubt, its publication output would fall far short of the estimated 457 publications.

The relationship described here does not indicate that funds produce research publications. It merely indicates that changes in funding levels are very closely associated with changes in the level of publication output.

The existence of a linear relationship between NIH funding and publication output is by no means self-evident. One might expect to find that highly funded institutions publish proportionately more than moderately funded ones since they tend to possess more elaborate research infrastructures than their smaller associates. That is, one might predict the existence of economies of scale.

On the other hand, one could argue that highly funded institutions are less efficient than smaller institutions. The argument might be based on the "too many cooks spoil the broth" principle. Thus one might predict the existence of diseconomies of scale.

Neither economies or diseconomies of scale are present in Figure 6-5.

A cross-section analysis was also performed on hospital data. The equation of this relationship is

$$Y = 3.63 + 0.0364X,$$

where again Y is publication output and X is thousands of NIH dollars. On the average, 3.64 publications are associated with \$100,000 shifts in funding levels for 52 large hospitals. The high funding-publication correlation, $r = .89$, indicates that the funding-publications link is probably linear. The t value associated with the intercept term indicates that the intercept term is not significantly different from zero at the 0.05 level. This might mean that, on the whole, NIH funding accounts for the major part of the research produced by large hospitals. If other funding sources played a substantial role in generating research output the intercept term should be larger than zero, which would indicate that some biomedical research is still being published in the absence of NIH funds. That does not seem to be the case with the 52 hospitals.

C. The Science Citation Index as a Publication and Citation Data Base

The Science Citation Index (SCI) appears to be by far the most widely applicable and generally appropriate data base for evaluative bibliometric work.

The reason for this lies in the complementary nature of the publication and citation data, both of which are contained in the SCI. Additional assets of the SCI as a data source are its timeliness, its total indexing of each journal covered, and its comprehensiveness across the entire central scientific literature. The SCI also has some drawbacks as a data base: the SCI is not as comprehensive as specific services in their specific subject areas; the SCI has some definite national biases; and the SCI's citation counts are enormously complicated by the first author problem.

The fact that one data base does provide complementary citation and publication data is of real significance. The citation data provide a means for estimating the quality or influence of a set of publications, as well as a means for measuring the structure of the scientific literature. The citation data also provide a means for investigating the interrelationship of different fields, and for defining the bounds on a set of publications which may be used to represent scientific capability.

The Science Citation Index is produced quarterly and cumulated annually by the Institute for Scientific Information in Philadelphia. Entered into the SCI tapes, for each article, letter, note, etc., in any journal covered by the SCI are the standard bibliographic information: authors, title, journals, volume, etc., plus all of the references contained in the publication. The presence of the references along with the source publication data provides the means for linking journals, authors, fields and institutions. The first regular Citation Index was issued in 1961, with 613 source journals and 1,370,000 citations. Since then SCI coverage has grown steadily to 2,443 journals and 5,231,000 citations in 1974; coverage is particularly good for the central English language journals in the physical and life sciences. Mathematics and psychology are reasonably well represented, as are some subfields of engineering. Economics and most of the social and behavioral sciences are not covered by the SCI, but are now covered by the Social Science Citation Index (SSCI),⁷ which completely covers 1,300 journals (with some SCI overlap) and selectively covers 1,300 others. Table 6-4 shows the basic SCI statistics for the 14 years of its existence, while Table 6-5 provides the same information for the 3 years of the SSCI.

⁷Institute for Scientific Information, Social Science Citation Index Guide and Journal Lists,[®] 325 Chestnut Street, Philadelphia, Pa., 19106, 1974.

TABLE 6-4

SCIENCE CITATION INDEX 1961-1974 COMPARATIVE STATISTICAL SUMMARY

	1961	1962	1963	1964	1965	1966	1967	1968	1969	1970	1971	1972	1973	1974
Source Journals	613	605	610	700	1,146	1,573	1,711	1,968	2,180	2,192	2,277	2,425	2,364	2,443
Source Journal Issues	5,031	5,595	5,505	5,497	9,432	12,444	13,815	15,911	17,761	17,992	18,976	19,384	20,493	25,508
Anonymous Source Journal Items	3,360	4,047	4,101	9,500	14,500	13,161	15,033	8,095	13,033	11,320	9,639	10,191	9,806	8,096
Authoried Source Journal Items	109,958	119,553	125,047	142,139	221,301	260,709	289,066	300,441	328,397	350,555	354,851	367,423	397,137	392,875
Total Source Journal Items	113,318	123,600	129,148	151,639	235,801	273,870	304,099	308,536	341,430	361,875	364,490	377,614	406,943	400,971
Citations to Authored Items*	1,349,800	1,457,862	1,531,200	1,742,896	2,663,806	3,014,737	3,319,546	3,626,027	3,777,272	4,041,165	4,302,885	4,579,183	4,938,132	5,148,630
Citations to Anonymous Items	20,200	21,299	22,204	35,282	52,894	48,443	53,149	57,118	56,958	55,357	61,037	62,884	61,989	65,265
Citations to Patents	6,474	6,474	5,396	11,575	208,240	10,826	14,444	15,570	15,485	11,425	15,783	17,048	17,299	17,815
Total Citations from Source Journal Items	1,370,000	1,485,635	1,558,800	1,789,753	2,924,940	3,074,006	3,387,139	3,698,715	3,849,915	4,107,947	4,379,705	4,659,115	5,017,420	5,231,710
Unique Reference Authors Cited*	258,000	266,641	281,296	323,889	435,915	473,658	510,113	546,567	601,410	619,872	645,505	688,320	710,992	730,001
Average Citations per Cited Author	5.23	5.47	5.44	5.40	6.08	6.36	6.50	6.64	6.28	6.52	6.67	6.65	6.95	7.05
Unique Authored Items Cited*	890,000	894,760	970,216	1,092,384	1,616,987	1,820,877	1,994,120	2,138,526	2,261,839	2,340,128	2,449,573	2,596,663	2,729,968	2,817,833
Citations per Authored Items Cited	1.52	1.62	1.58	1.60	1.65	1.65	1.66	1.67	1.67	1.73	1.76	1.76	1.81	1.83

*excepting Patents

TABLE 6-5

SOCIAL SCIENCES CITATION INDEX 1972-1974 COMPARATIVE STATISTICAL SUMMARY

	1972	1973	1974		1972	1973	1974		1972	1973	1974		1972	1973	1974
Selective Coverage Source Journals															
Fully Covered Source Journals	1,212	1,158	1,274		970	1,082	1,278								
Anonymous Source Journal Items	1,998	2,255	2,604												
Authored Source Journal Items	71,152	67,661	80,451												
Total Source Journal Items	73,150	69,916	83,055												
Citation to Authored Journal and Monograph Items	535,382	563,900	781,759												
Citations to Anonymous Items	44,909	43,045	62,632												
Citations to Corporate Author Items	23,491	26,493	27,185												
Total Citations from Source Journal Items	603,782	634,438	871,576												
Unique Authored Items Cited	400,062	414,900	576,631												
Citations per Authored Items Cited	1.34	1.36	1.35												
Unique Reference Authors Cited	158,000	165,700	230,031												
Average Citations per Cited Author	3.39	3.41	3.40												
Number of Corporate Addresses	64,063	62,607	73,943												
Number of Unique Source Authors	63,391	63,450	73,351												
Average Number of References per Article	8.25	8.06	10.5												

	Percentage of Total Citations				Percentage of Unique Citations				Cumulative Percentage of Total Citations				Cumulative Percentage of Unique Citations			
	1972	1973	1974	1974	1972	1973	1974	1974	1972	1973	1974	1974	1972	1973	1974	
1974				1.55				1.91				1.55				
1973		1.90	8.69	1.55			2.31	9.28			1.90	1.55			1.91	
1972	2.27	8.72	10.54	10.54	2.73	9.34	10.63	10.63	2.27	10.62	20.78	10.62	2.73	11.65	21.82	
1971	9.49	10.50	9.12	9.12	9.79	10.68	8.99	8.99	11.76	21.12	29.90	21.12	12.52	22.33	30.81	
1970	10.63	9.36	8.03	8.03	9.29	9.29	7.71	7.71	22.39	30.48	37.93	30.48	23.11	31.62	38.52	
1969	9.14	8.01	6.92	6.92	8.94	7.75	6.54	6.54	31.53	38.49	44.85	38.49	32.05	39.37	45.06	
1968	7.86	7.10	6.02	6.02	7.61	6.71	5.64	5.64	39.59	43.59	50.87	43.59	39.66	46.08	50.70	
1967	6.58	6.03	5.14	5.14	6.31	5.68	4.80	4.80	45.97	51.62	56.01	51.62	45.97	51.76	55.50	
1966	5.63	5.24	4.49	4.49	5.24	4.76	4.12	4.12	51.60	56.86	60.50	60.50	51.21	56.52	59.62	
1965	4.98	4.47	3.90	3.90	4.69	4.16	3.65	3.65	56.58	61.33	64.40	64.40	55.90	60.68	63.27	
1964	4.12	3.75	3.27	3.27	3.86	3.51	3.07	3.07	65.08	65.08	67.67	67.67	59.76	64.19	66.34	
1963	3.59	3.28	2.88	2.88	3.33	3.02	2.69	2.69	64.29	68.36	70.55	70.55	63.09	67.21	69.03	
1962	3.25	2.88	2.56	2.56	2.94	2.59	2.33	2.33	67.71	72.24	73.11	73.11	66.03	69.80	71.36	
1961	2.71	2.42	2.19	2.19	2.57	2.25	2.09	2.09	70.25	73.66	75.30	75.30	68.60	72.05	73.45	
1960	2.49	2.23	1.99	1.99	2.29	2.06	1.87	1.87	72.74	75.89	77.29	77.29	70.89	74.11	75.32	
1959	2.08	1.87	1.68	1.68	1.94	1.74	1.59	1.59	74.82	77.76	78.97	78.97	72.83	75.85	76.91	
1958	1.95	1.73	1.55	1.55	1.76	1.55	1.41	1.41	76.77	79.49	80.52	80.52	74.59	77.40	78.32	
1957	1.67	1.54	1.39	1.39	1.50	1.36	1.27	1.27	78.44	81.03	81.91	81.91	76.09	78.76	79.59	
1956	1.46	1.34	1.22	1.22	1.36	1.26	1.14	1.14	79.80	82.37	83.13	83.13	77.45	80.02	80.73	
1955	1.24	1.08	0.97	0.97	1.22	1.07	0.97	0.97	81.14	83.45	84.10	84.10	78.76	81.09	81.70	
1954	1.20	1.00	0.97	0.97	1.14	0.95	0.93	0.93	82.34	84.45	85.07	85.07	79.81	82.04	82.63	
1953	1.06	0.95	0.88	0.88	1.00	0.89	0.84	0.84	83.40	85.40	85.95	85.95	80.81	82.93	83.47	
1952	0.86	0.76	0.72	0.72	0.87	0.78	0.74	0.74	84.26	86.16	86.67	86.67	81.68	83.71	84.21	
1951	0.84	0.73	0.70	0.70	0.84	0.73	0.70	0.70	85.10	86.89	87.37	87.37	82.52	84.44	84.91	
1950	0.78	0.71	0.64	0.64	0.77	0.68	0.63	0.63	85.89	87.60	88.01	88.01	83.29	85.12	85.54	

The cover-to-cover inclusion of material from each of the journals covered by the SCI is a point of real importance in evaluative work. Most of the abstracting services have a core of journals which they cover completely and then a large number of other journals which are covered selectively. Thus, in using these services the evaluator is never sure that a particular publication will be included. The criterion for inclusion is the subjective judgment of the abstractor as to the value or appropriateness of the publication.

The SCI covers the more peripheral and foreign journals somewhat less extensively. This less extensive coverage is illustrated by Figure 6-6, from a Computer Horizons study of the literature of alcoholism. The figure is a two-step map of the journal literature of alcoholism in which two arrows have been drawn showing the journals cited first and second most frequently by articles on alcoholism in the referencing journal. The alcoholism literature seems to have two distinct sections, represented by the upper and lower parts of the figure. The upper part of the figure maps psychosocial and biosocial research associated with alcoholism while the lower part maps a sector of alcoholism research which is embedded within the general biomedical literature. Those journals which were not covered by the SCI have accentuated borders. Of the 59 journals on the map, 14 are not covered by the SCI; many of the non-covered journals are small and peripheral, and most are foreign.

Another major advantage of the Science Citation Index as a bibliometric data base is its substantial and uniform coverage across the central scientific literature, with special focus on those journals of significance to U.S. science. Thus, if a scientist has changed fields or published in the border line areas between fields or has interest in a number of different fields, he is far more likely to be completely covered in the Science Citation Index than in any of the specialized services.

Appendix I contains a listing of 2,300 SCI-covered journals, classified into 9 major fields and approximately 100 sub-fields. SCI coverage data for the major fields is contained in Table 6-6. Approximately 53% of the publications are in the biology-biomedicine-psychology complex; 32% are physics, chemistry or mathematics, while the remaining 15% are in earth and space science and engineering.

Another asset of the SCI is the timeliness of its coverage. While most of the conventional abstracting services strive for timeliness, even a glance will reveal that articles are appearing in 1975 with publication dates as old as 1971 or 1972. Most of these services are reasonably timely for most of the English language central literature; however, the fact that

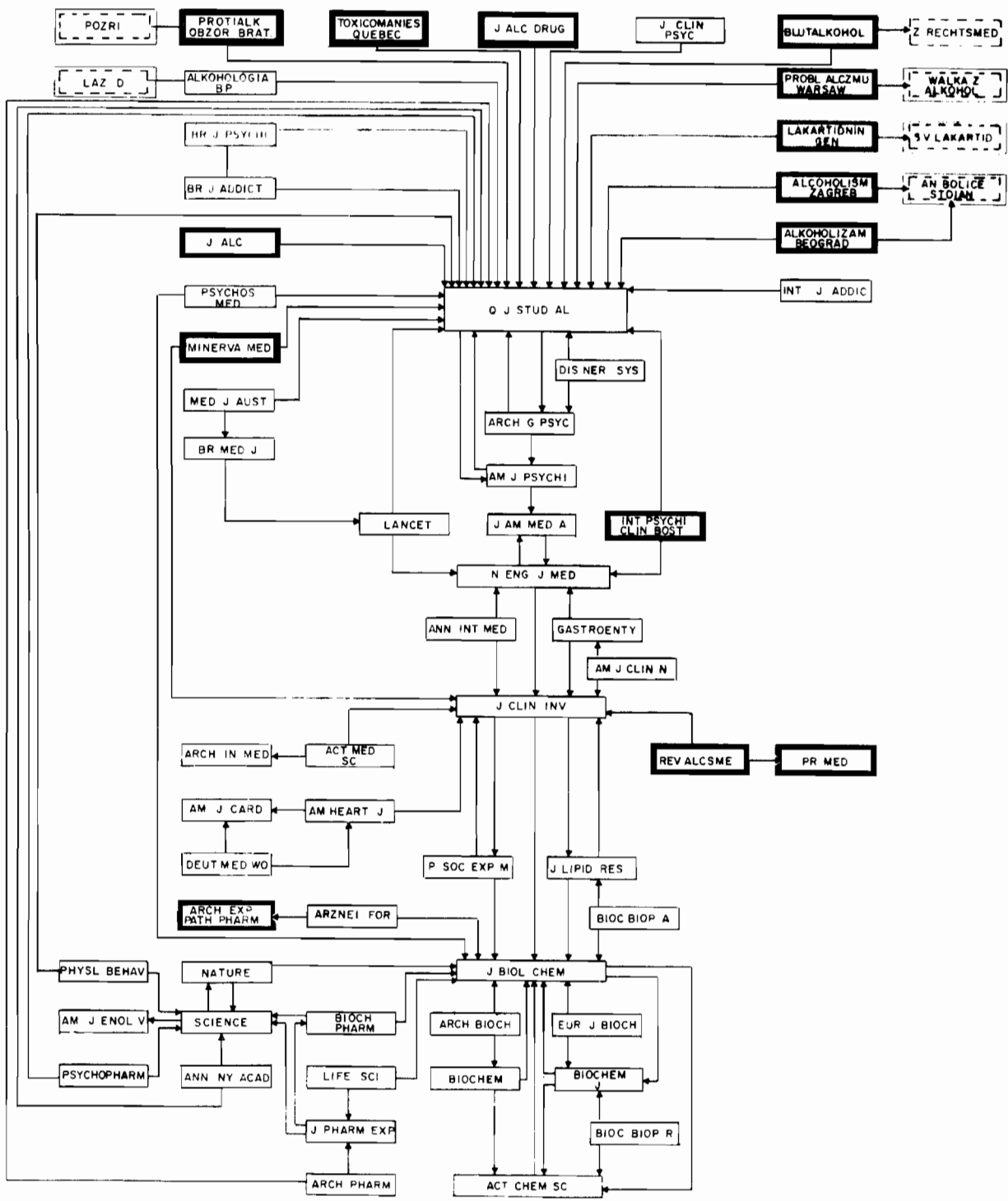

FIGURE 6-6

TWO-STEP REFERENCING MAP OF THE ALCOHOLISM RESEARCH LITERATURE

TABLE 6-6

MAJOR FIELD COVERAGE BY SCI IN 1973
(Multi-Field Journals Omitted)

Field	# Journals Covered by SCI	# SCI Covered Publications in Field (Articles, Notes, and Reviews)	# References from Field to SCI Covered Journals	# Citations to Field from SCI Covered Journals
Clinical Medicine	644	75,000	1,091,000	975,000
Biomedical Research	275	33,000	614,000	664,000
Biology	294	23,000	224,000	177,000
Chemistry	186	42,000	588,000	572,000
Physics	123	33,000	416,000	464,000
Earth & Space Science	115	10,000	128,000	113,000
Engineering & Technology	428	28,000	162,000	135,000
Psychology	91	7,000	70,000	64,000
Mathematics	90	7,000	38,000	44,000
TOTAL	2,246	258,000	3,331,000	3,208,000

many conventional services use outside abstractors leads to more extended time lags than appears to be true for the Science Citation Index.

A short study was made of the timeliness of the Science Citation Index, by analyzing the number of publications dated 1972 on the 1973 Corporate Tapes. Over 11% of all articles on the 1973 tape have 1972 publication dates. For journals published in the U.S. and U.K., the figure is approximately 7 1/2%, while for journals published outside of the U.S. and U.K. the figure is nearly 20%. Table 6-7 lists a breakdown, by country of origin of the journals, of the 1972 publications on the 1973 Corporate Tapes.

On a journal-by-journal basis there were 118 journals with more than 50 1972 publications on 1973 Corporate Tapes. Of course, much of this is unavoidable, since many journals publish late, and foreign journals are sometimes delayed in transit. However, somewhat surprisingly, some of the large central journals such as the Physical Review, the Journal of the American Chemical Society, the Journal of Biological Chemistry, Lancet, and Proceedings of the National Academy of Science were among the 118 journals with a time-lag in indexing. Many large Soviet journals were also on this list of journals. Most of those 1972 articles on the 1973 tape were probably covered in the first quarter 1973 and few publications are dated earlier than 1972. As a result, reasonably complete coverage of a year is possible if the first quarter of the following year is included in a count.

The national biases within the SCI data base are described in Chapter II. It appears that among the major countries, the SCI data base is somewhat biased toward the U.S. in systematic biology and mathematics, but reasonably representative of all the major countries in the fields of physics, chemistry, biomedical research, clinical medicine, psychology, engineering, and earth and space sciences.

An informal analysis by Computer Horizons indicates that the SCI tends to cover the major and general journals in the smaller countries, while not covering the more specialized literature in as much depth as it covers the more specialized U.S. literature. Thus, the analyst should be exceedingly cautious in using the SCI to evaluate the local components of the literature of the smaller nations. However, for the major nations in the major scientific fields, coverage is generally adequate.

TABLE 6-7

COUNTRY BREAKDOWN OF 1972 PUBLICATIONS ON 1973 SCI CORPORATE TAPE

Country Name	# of 1972 Articles, Letters, Notes and Reviews on 1973 Tape	# of 1973 Articles Letters, Notes and Reviews on 1973 Tape	% 1972 on 1973 Tape
UNITED STATES	9,389	116,043	7
UNITED KINGDOM	3,030	38,877	7
GERMANY (WEST)	2,085	18,734	10
FRANCE	2,083	9,614	18
USSR	4,085	18,654	18
JAPAN	1,870	7,967	19
AUSTRALIA	360	2,073	15
AUSTRIA	122	1,047	10
BELGIUM	168	595	22
BULGARIA	201	272	42
CANADA	718	4,514	14
CHINA (TAIWAN)	30	25	55
CZECHOSLOVAKIA	253	1,702	13
DENMARK	674	2,900	19
GERMANY (EAST)	783	3,650	18
HUNGARY	486	833	37
INDIA	763	2,186	26
IRELAND	61	194	24
ISRAEL	145	385	28
ITALY	980	2,178	31
NETHERLANDS	1,694	16,196	9
NORWAY	65	465	12
POLAND	568	1,663	25
PORTUGAL	17	0	100
ROMANIA	93	390	19
SPAIN	85	203	30
SWEDEN	408	1,561	21
SWITZERLAND	1,386	4,677	23
YUGOSLAVIA	24	98	20
FINLAND	85	179	32
ARGENTINA	57	118	33
BRAZIL	62	35	64
CHILE	38	129	23
COLUMBIA	3	0	100
COSTA RICA	17	53	24
IRAN	10	0	100
LUXEMBOURG	5	1	83
MEXICO	50	63	44
MONACO	0	9	0
NEW ZEALAND	104	611	15
SOUTH AFRICA	49	670	7
VENEZUELA	86	0	100
TOTAL	33,192	259,564	11
TOTAL LESS US AND UK	20,773	104,644	20

D. Use of the Science Citation Index

For a complete and lucid description of the mechanics of the Science Citation Index, including its structure and coding system, the interested analyst should obtain a copy of Science Citation Index Guide and Journal Lists⁸ from the Institute of Scientific Information, 325 Chestnut Street, Philadelphia, Pennsylvania 19106. This publication is updated annually and provides far more detail and information than can be included in this section.

1. Corporate Index for Institutional Publication Analysis

The Corporate Index of the Science Citation Index is a particularly powerful tool in analysis and evaluation, since it groups all of the publications of any institution by institutional name. This section of the Science Citation Index contains an alphabetical list of publications sorted by the institutional affiliations of the authors. The Corporate Index allows the analyst to identify all of the papers associated with an institution.

Without the Corporate Index, a list of publications of any given institution would have to be constructed by first obtaining a list of the scientists associated with that institution. Obtaining such a list would be a difficult task. Faculty and research staff lists are not easy to obtain, often out of date, and certainly never complete because of constant changes, the presence of visiting professors and scientists, the flow of graduate students, professors and scientists who have just left or joined the institution, and so forth. Furthermore, a departmental faculty list will often not reflect the actual activity in a given scientific area in a university, since faculty members in closely related departments may be working jointly with any given department. Thus the Corporate Index provides a very convenient tool for the institutional identification of publications.

Unfortunately, there are a number of complexities in the arrangement of the Corporate Index which must be kept in mind.

The first of these complexities relates to the multiple institutional author and the first author problem. If a paper

⁸Institute for Scientific Information, Science Citation Index Guide and Journal Lists® Philadelphia, Pa. 19106, 1974.

is authored by three scientists, two of whom are at Harvard, and one of whom is at Yale, the paper will appear once each under Harvard University and Yale University in the printed Corporate Index.* In both cases the reference under the institutional name will be identical, identifying the first author's name, the journal, volume, page and year. A publication will appear in the Corporate Index approximately as many times as there are separate institutions affiliated with the authors. Thus, if two authors give three affiliations, (for example, the first author performs work at Yale while on leave from Stanford, while the second author comes from Harvard) the publication may appear with the first author's name under Yale, Harvard and Stanford.

The first author characteristic of the Corporate Index has one substantial benefit: the analyst can go immediately to the Citation Index and look up the citations to the paper, since these are almost always to the first author. However, finding a paper in the Corporate Index does not immediately tell the analyst how many papers really come from that institution, since a multi-authored paper would normally be attributed partially to each institution. The only way the attribution can be done fairly, by hand, is to go back to the Source Index and find out how many actual authors each paper has. However, this information still doesn't reveal how many articles come from each institution, since institutional data does not appear in the Source Index. Although the number of individual authors is not necessarily the same as the number of institutional authors, and a paper will only appear once under an institutional name even if it has two actual authors from a given institution, a reasonable approximation can be obtained by fractional attribution of authorship. Otherwise the analyst would have to go back to the actual paper itself to find the affiliation of each author.

When dealing with the Corporate Index tapes, the problems, of attributing multiple corporate authorship are easily overcome. First, the tape can be sorted by the SCI identifying number, a number uniquely identifying each publication entered into the SCI tapes. Then the tape can be scanned for repeated identifying numbers, and a paper which appears three times in the Corporate Index can be tagged with the fraction one-third, and so forth. The tape can then be resorted in alphabetical order. After the publications are identified with a given institution, they can be fractionally attributed to that institution.

*On the tapes the paper will appear 3 times, once under Yale with the first author's name, and twice - as 2 identical records - under Harvard with the first author's name: one of the two Harvard records on the tape is suppressed by the print program.

In dealing with any part of the scientific literature the analyst is always faced with the problem of unification of variant names. For the Corporate Index unification consists of identifying and/or transforming all variants of a given organization name. For example, on the corporate tapes, Harvard University has at least 300 variant names, corresponding to different departments and schools of the university. Before ISI instituted more standardized procedures in 1973, unification was a particularly frustrating problem. Figure 6-7, a part of Harvard's listings from the 1973 Corporate Index, illustrates the unification problem.

By including the location of the organization, for 1973 and subsequent years, the Corporate Index tapes provide a convenient tool for publication counts by geographic area. Prior to 1973, explicit location was not contained within the corporate tapes, and country attribution had to be done by first identifying a country's institutions, and then grouping the publications of the institutions.

For 1973 and subsequent years, ISI includes a country code in the Corporate Tapes. In addition, for the United States, the individual state and city are identified. The state and city identification allows, for example, the different campuses of the University of California to be separated, an almost hopeless task prior to 1973.

2. Source Index for Individual Publication Analysis

The Source Index of the SCI lists in alphabetical order the names of every author of every source item processed for the SCI. Full bibliographic data on each source name are given under the name of its first author. The names of all secondary authors are cross-referenced to that of the first author. An author's name appears only once, and beneath it are given: 1) the one or more source items of which he or she was the first author during the year and 2) cross-references to other source items in which he or she was a secondary author. For papers where the author is a secondary author, the analyst then has to go to the first author listing to find out how many source authors there were if, for example, the analyst wishes to partially attribute a paper equally among its various authors. This tends to be time consuming.

The most important evaluative use of the Source Index is to establish publication records for an individual. Establishing these records is a relatively straightforward task requiring, however, that secondary authorships also be counted. The only real complexity is the change in source coverage in the Science Citation Index from 1961 to the present day. To look for trends in the publications of an individual over his career, great care

HARVARD UNIV

Table listing Harvard University faculty members, including names, departments, and contact information.

HARVARD UNIV

Table listing Harvard University faculty members, including names, departments, and contact information.

HARVARD UNIV

Table listing Harvard University faculty members, including names, departments, and contact information.

HARVARD UNIV

Table listing Harvard University faculty members, including names, departments, and contact information.

HAI

Table listing Harvard University faculty members, including names, departments, and contact information.

FIGURE 6-7

has to be taken either to exclude publications in journals which have been added recently, or to go back to some other indexing sources and find publications that have been omitted. This, however, is a minor limitation compared to using one of the more standard abstracting and indexing services which may or may not cover an individual's publications depending upon both the journal in which the publication appears and some subjective estimate of its relevance or quality. At least, in dealing with the Citation Index, the publication will be there if the journal is covered.

Figure 6-8 from the 1974 SCI Guide and Journal List, describes the basic structure of the printed Source Index.

The type of publication coding illustrated in the lower right portion of this figure appears to be done in a careful and consistent way; however, the analyst is warned that changes have occurred. For example, prior to 1970 the "L" category included "letters" of all kinds, including all items in such journals as Physics Letters and Physical Review Letters. Since then, only letters of the letters-to-the-editor type are included in the "L" category; the items in the two previously mentioned journals are now classified as regular articles. As a result of this, counts of publications in physics may have strange discontinuities if only one of those types of publications is included.

3. Citation Index for Citation Analysis

The Citation Index section of the SCI is the most unique aspect of this data base, and the one which provides a large part of the data for the field of evaluative bibliometrics. Entries in the Citation Index are arranged alphabetically by cited author. All citations to a scientist's work are arranged chronologically by journal title under his name. Beneath each reference appears, in alphabetical order by first author, the bibliographic data for the referencing articles.

The name of the cited author appears only once, at the head of the list of referencing articles. Figure 6-9, from the 1974 SCI Guide and Journal List, describes this structure.

The major problem with the manual use of the Citation Index concerns ambiguities in cited authors' names, since the Citation Index only lists the last name and initials of cited authors. These ambiguities become a very confusing and serious problem when dealing with scientists with common names, unless the analyst already knows which papers are associated with each of the authors with a given last name and initials. This association cannot be accomplished easily since the analyst faces exactly the same problem if he looks under the papers for K. Smith in the Source Index.

Source Index

To locate a full description of a source item, look up the first author. Under a given name, journal articles of primary authorship are described first. Items of secondary authorship follow and are cross-referenced to the first author whose name follows the word SEE.

First Source author — **ALEXANDE, RW**

Coauthors —

- GILL JR YAMABE H LOVENBER W KEISER HR EFFECTS OF DIETARY SODIUM AND OF ACUTE SALINE INFUSION ON INTERRELATIONSHIP BETWEEN DOPAMINE EXCRETION AND ADRENERGIC ACTIVITY IN MAN
J CLIN INV 54(1):194 74 41R
- DUPUIS RH HOLTON H—CENTRAL MUCOEPIDERMOID TUMOR (CARCINOMA) OF MANDIBLE
J ORAL SURG 32(7):541 74 41R
- KOVENER GS BELL RJ—DISPERSION CURVES FOR SURFACE ELECTROMAGNETIC WAVES WITH DAMPING
PHYS REV L 32(4):154 74 15R

NB: Source citations follow the pertinent source titles

- see BRERETON HD N ENG J MED 291 83 74
- see " " " " 291 795 74
- see JAMES RB ORAL SURG O 37 189 74
- see WARD CA APPL OPTICS 13 2378 74
- see WEAVER JH J PHYS CH S 35 1625 74
- see WESTWOOD RM ORAL SURG O 37 83 74

R.W. ALEXANDE, is first author of these Source items.

R.W. ALEXANDE, is one of the secondary authors of these Source items.

ALEXANDE, S

- MAKAR Y ELLIS FH—RECURRENT VENTRICULAR FIBRILLATION—TREATMENT BY EMERGENCY AORTOCORONARY SAPHENOUS VEIN BYPASS
J AM MED A 228(1):70 74 N 13R
- BARAM A LUZ Z—SOME MATHEMATICAL PROPERTIES OF MAGNETIC RESONANCE LINE SHAPES
J CHEM PHYS 61(3):992 74 13R
- YUVAL G—3 SPIN STATE GENERALIZED ISING MODEL
J PHYS C 7(9):1609 74 21R
- STAVRIC V SUGAR J SCHWERS J—EFFECT OF A DIURETIC ON URINARY EXCRETION OF ESTROGENS IN PREGNANT WOMAN
J STEROID B 5(4):365 74 M NO R
- SPECTOR R—PHENOLPHTHALEIN IN ASPIRIN
LANCET 2(7886):961 74 L NO R
- BARAM A LUZ Z—CORRELATED SOLID-LIKE JUMPS AND RESONANCE LINE SHAPES IN LIQUIDS
MOLEC PHYS 27(2):441 74 21R
- HALL R—ANATOMICAL OBSERVATIONS ON CHRYSANTHEMUM PLANTS INVADDED BY VERTICILLIUM DAHLIAE
PHYTOPATHOL 64(5):578 74 M NO R
- EFFECT OF COLD ON CARDIOVASCULAR SYSTEM
PRACTITION 213(1278):785 74 1R
- CROSS-REFERENCED SECONDARY AUTHOR —
- CONTINUOUS PHASE TRANSITIONS WHICH SHOULD BE FIRST ORDER
SOL ST COMM 14(11):1069 74 7R

Source journal

Source journal volume

Source journal issue number in parenthesis (S indicates Supplement)

Source journal page (after colon)

Source journal year

Number of reference citations

Codes indicating type of source item

- Blank articles, reports, technical papers, etc.
- A abstracts of published items
- C corrections, errata, etc.
- D discussions, conference items
- E editorials, editorial-like items
- I items about individuals (tributes, obituaries, etc.)
- L letters, communications, etc.
- M abstracts from meetings
- N technical notes
- Q bibliography for SCI[®] supplied after primary publication, by source author
- R reviews & bibliographies

First Source authors —

- see HUDSON MJ BR VET J 130 R 37 74
- see LEAT WMF P NUTR SOC 32 A 97 73

Language code —

- ALEXANDR, JH** (FR) ACUTE POSTOPERATIVE ULCER—CLINICAL DIAGNOSIS
ANN CHIR 27(12):1245 73 NO R
- GUERRIER, M** (FR) VAGOTOMY AND PYLOROPLASTY IN POSTOPERATIVE ULCERS
ANN CHIR 27(12):1260 73 18R

Language codes

AR	ARABIC	MA	MALAY
BE	BENGLISH	NO	NORWEGIAN
BU	BULGARIAN	PE	PERSIAN
CH	CHINESE	PO	POLISH
CZ	CZECH	PT	PORTUGUESE
DA	DANISH	RM	ROMANIAN
DU	DUTCH	RS	HUSSIAN
FI	FINNISH	SC	SRB (ROTN)
FR	FRENCH	SK	SLOVAK
GA	GAELIC	SL	SLOVENIAN
GE	GERMAN	SP	SPANISH
GR	GREEK	SW	SWEDISH
HE	HEBREW	UK	UKRAINIAN
HU	HUNGARIAN	XX	MULTILING.
IT	ITALIAN	(blank)	ENGLISH
JA	JAPANESE		

FIGURE 6-8

Citation Index

To find source items that cite a specific paper.

1. locate cited author
2. locate reference year
3. locate reference publication, volume, and page
4. note that source (citing) items follow reference (cited) items

	AARONSON A					
	61 <i>BIOCHIM BIOPHYS ACTA</i>	53	70			
	TROPP BE			24	855	70
Cited author	AARONSON AL					
Cited reference	68 <i>ANN ALLERG</i>	26	145			
	TEMPERO KF			48	149	70
	AARONSON AS					
Source citation	61 <i>BIOCHIM BIOPHYS ACTA</i>	49	98	131	30	70
	MARCHETT M			106	1703	70
	AARONSON BS					
Reference year	55 <i>THESIS U MINNESOTA</i>					
	RICE JK					
	59 <i>J CLINICAL PSYCHOLOG</i>	15		48	76	50 70
	61 <i>J CLINICAL PSYCHOLOG</i>	17		245	34	15 70
Reference journal	SINGER MI					
	64 <i>J GERONTOL</i>	19	144	R	21	239 70
	BOTWINIC J			J	18	160 70
Reference volume and page	68 <i>AM J CLIN HYPNOSIS</i>	9				
	SACERDOT P					
	68 <i>J GERONTOL</i>	21	458	R	21	239 70
	BOTWINIC J					
	BRITTON JO				24	657 69
	AARONSON D					
	66 <i>THESIS U PENNSYLVANI</i>					
	RUMELHARDI J				7	191 70
	67 <i>PSYCHOLOGICAL</i>	8	67	150	21	319 69
	DIESPECK DD				27	139 78
	GOODMAN SJ				17	341 69
	GRANT KW				86	164 70
	JOHNSTON WA				83	1 70
	MADSEN MC				83	238 70
	MASSARO DW				7	153 70
					77	557 70
	PATTON WF				30	691 70
	POLT IM				19	329 70
	THOMAS IB				48	1010 70
					48	1303 70
					7	219 70
	WICKELGR WA					
	67 <i>PSYCHOLOGICAL REVIEW</i>	67	150			
	FREY WG				85	105 70
	68 <i>J EXP PSYCHOL</i>	76	129			
	HOCK HS				83	299 70
	LOWE DG				24	169 70
	AARONSON G					
	69 <i>ELECTRONICS</i>	118				
	MOSCHYTZ GS				7	63 70
	AARONSON HG					
	62 <i>J AM MED ASSOC</i>	182	678			
	SZAFRANO H				21	509 69
	AARONSON HI					
	**IN PRESS					
	LIU YC				18	845 70
	57 <i>REV SCI INSTR</i>	28	579			
	KINSMAN KR				1	1485 70
	62 <i>DECOMPOSITION AUSTEN</i>				387	
	AARON HB				18	699 70
	BASTERFIJ				8	131 69
	CHILTON JM				1	1019 70
	HALL MG				18	331 70
	LIU YC				18	845 70
	STURT BA				37	815 70
	WEATHERLGC				8	105 69
	62 <i>T AJME</i>	224	693			
	MAITRE FL				67	563 70

Codes indicating type of source item:
 Blank articles, reports, technical papers, etc.
 A abstracts of published items
 C corrections, errata, etc.
 D discussions, conference items
 E editorials, editorial-like items
 I items about individuals (tributes, obituaries, etc.)
 L letters, communications, etc.
 M meeting abstracts
 N technical notes
 R reviews & bibliographies

H.I. Aaronson's 1957 article in *Review of Scientific Instruments* was cited by K.R. Kinsman in a note published in *Metallurgical Transactions*

To locate sources that cite a particular work, first look for the name of the cited or reference author in bold roman capital letters on the left. For each cited paper by that author there is a line in bold italics, giving reference year, title abbreviation, volume and page numbers. When the same reference has been cited more than once the source citations are arranged alphabetically by first author. Each source citation gives the name of the first author, followed by journal title abbreviation, source item type code, and volume, page, and year. Though only first authors are given in the *Citation Index* proper, all authors will be listed in the *Source Index*.

Patent Citation Index

When a patent is cited in a source item the arrangement of the information is altered slightly. As shown in the example below, the cited patent number is used in place of the authors last name. The Patent Section is numerically arranged. Additional information is displayed in sequence as: cited reference year, inventor's name, country of issuance, and application or reissue status.

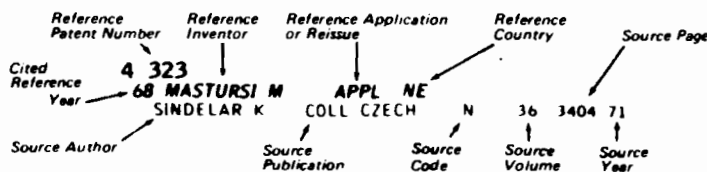

FIGURE 6-9

SCI CITATION INDEX STRUCTURE

If the analyst knows the scientist's institutional affiliation, he can go to the Corporate Index and attempt to discriminate between the two K. Smiths there.

When the fields of two scientists are widely different, the analyst may simply assume that all of the physics citations and papers are from one author and all of the biomedical citations and papers are from another. This assumption is valid providing that the analyst is attempting to establish the publication and citation records of the physicist or the biomedical scientist. However, in many areas such an easy differentiation cannot be made, and the original publications must be checked in order to separate the two.

One way to avoid the tedious job of looking up individual citations is to take an average citation record for the publications in a given journal and use this to assign an average citation rate or average influence to a given journal. This approach has been developed into the influence methodology discussed in the next three chapters. The influence methodology provides a reasonable approach when the number of papers under consideration is of the order of 100 or more. The methodology still requires, however, the unequivocal identification of each author's papers.

The unification of cited journal names is a necessary prerequisite for general statistical studies of citations to journals. This unification is difficult because of the incredible variety of names used as journal abbreviations within the scientific community. The SCI tapes now include some 2,400 source journals; the number of different journal names cited in a given year is in excess of 75,000. These names will include, for example, many different variants of J AM MED A which is the standard SCI abbreviation for the Journal of the American Medical Association. For example, some of the variants of J AM MED A found in the 1973 SCI were:

<u>Variant</u>	<u>Number of Times Cited</u>
J AM MED A	472 (SCI Standard)
J AM MED ASS	10,438
J AM MED ASSN	91
J AM MED ASSOC	698
J AM MEDICAL ASSOCIA	643
JAMA	5,559

In recent years ISI has been consistently using standard abbreviations (J for Journal, AM for American, etc.) which has helped greatly. Both ISI and Computer Horizons now have unification thesauri which identify many thousands of variants of the most common journal names.

4. Special Problems in Citation Analysis on an Individual Author Basis

The following paragraphs will summarize some of the pitfalls of citation analysis, especially for individual authors. Most of these pitfalls can be overcome, but only at a substantial cost when dealing with more than a few dozen individuals. Most of the pitfalls have been mentioned previously: their appearance here will allow them to be viewed as a group.

a. Multiple Authorship

One difficulty in using the Science Citation Index for citation analysis on an individual author level stems from the fact that the indexes give credit for the citation only to the first author of the publication. Although not a problem when dealing with one-author papers, this practice presents obvious difficulties with multi-authored papers.

Zuckerman⁹ points out that there has been a substantial growth of multi-authored papers since the turn of the century. She further points out that there are no fixed rules for the order in which authors' names appear. The two primary patterns of ordering are 1) alphabetical and 2) alphabetical with one author out of sequence. The difficulty arises in determining the reason for an author's name being out of sequence. Ideally, the author who was principally responsible for the content would appear first. But in many cases this ideal may not be achieved: a junior scientist may defer to one of his seniors, an employee may defer to his boss, a grantee may defer to the grants officer or, conversely, an eminent scientist may wish to give one of his subordinates some credit. Zuckerman studied the same ordering on papers associated with Nobel laureates. The contribution of the laureate is often of major importance to an article, yet the laureates often abide by the standard of "noblesse oblige" and allow others to gain credit by having their names appear first. Of the 3,367 papers representing the work of 39 laureates, 66% did not list the laureates' names first.

Often, especially in industry, a scientist will include his co-workers as co-authors. For instance, one participant in a program studied by Computer Horizons wrote seven articles and delivered six papers at meetings, all with the same eight co-authors. Needless to say, all eight co-authors could not have performed equal work on all thirteen publications.

b. Self-Citations

One of the most time consuming problems in citation analysis for individual authors is controlling for self-citations.

⁹Zuckerman, "Nobel Laureates in Science: Patterns of Productivity, Collaboration, and Authorship."

Scientist as a First Author

For publications in which the scientist is the first author, controlling for self-citations is relatively easy. This control requires looking up all articles for which the scientist is the first author and compiling a list of co-authors. The list of co-authors is then checked against the citations credited to the scientist. Any citation made by a co-author of the scientist is then eliminated.

Scientist not a First Author

Controlling for self-citations when the scientist is not the first author is much more tedious. In this case each of the papers for which the scientist might be a co-author has to be found in the Source Index, and a list of all authors for each paper compiled and compared with the citation record of the participant and of the first authors.

An example of the above is the case of J.S., one of ten co-authors of a paper published in NUCL PHYS B. G.B. was the first author. Citations to this publication will appear under G.B.'s name.

In 1973, under G.B.'s name, there was one citation. The reference was made by an A.D. in JETP LETTER. A.D. was not one of the ten co-authors of the original paper. However, it is necessary to determine that the article in JETP LETTER was not co-authored by A.D. and any one of the original ten co-authors, for if it was it would be counted as a self-citation. This requires looking up the article by A.D. in the Source Index.

Without searching every citation, compiling the above lists, then checking the lists against the Citation Index, the analyst cannot be certain of controlling adequately for self-citations. Needless to say, these procedures are very time consuming when dealing with a substantial sample of participants.

c. The Homonym Problem

The homonym problem in citation analysis is cumbersome. SCI's practice of listing only the last name, the first name and (sometimes) the middle initial of an author often makes it difficult for a researcher to track down a particular scientist. Many scientists (e.g., father-son teams) with duplicate last names and first initials publish within the same field. Trying to distinguish one specific scientist from all other authors with the same name is very time consuming. The sheer bulk of data that must be reckoned with is formidable. In reviewing a scientist's publications over a three or four year period the analyst may have to deal with as many as 40 articles published by the scientist. Furthermore, scientists with more than 100 citations per year to their credit are not uncommon.

Ultimately, the homonym problem can be resolved by manually scanning the original cited works, but such an undertaking is extremely costly even if all of the publications could be located. For statistical studies, the dangerous procedure of excluding scientists with common names may be a necessity.

d. Field Variations in Citations

The citation rates of scientists and engineers in different fields vary greatly. For example, in a small Computer Horizons' study of a group of scientists associated with a specific program:

57 physical & biomedical scientists averaged 17 citations/year
30 agricultural scientists averaged 4 citations/year
27 engineers averaged 1 citation/year.

The small number of citations for engineers could be attributed in part to the lack of coverage by SCI and/or the fact that engineers seem to prefer society proceedings to journal articles as a medium for information exchange.

When dealing with the many heterogeneous fields of science, the analyst may come across subfields which are highly autonomous. These autonomous subfields often have their own unique, influential journals. Since these journals are usually very specialized and do not contribute much to the parent field as a whole, they may be excluded from SCI coverage. In dealing with individual publication analysis for these cases, the scientist will not be given credit for his true number of citations. Using the field of agriculture as an example, there are areas such as dairy science, animal breeding, rangeland management, soil engineering, crop growing and forestry which are grouped within the field of agriculture but may not be adequately covered by the SCI.

e. Short Term Fluctuations

In looking at citation patterns associated with individual scientists, the analyst occasionally encounters puzzling anomalies. For one study, a three year period (1971 through 1973) was chosen as the time span. In approximately 2% of the 400 subjects the number of citations varied greatly from one year to the next.

For example, B. in a Department of Nuclear Engineering, had the following citation record:

Citing Year		
1971	-	23 cites
1972	-	7 cites
1973	-	46 cites

The 1973 citations include 23 citations to articles published in 1971 and 14 citations to articles published in 1972. There seems to be little explanation for the 1972 drop in citations.

O.B., a biochemist, has a different citation record:

Citing Year		
1971	-	66 cites
1972	-	108 cites
1973	-	89 cites

Little explanation can be offered for the rise in 1972. The analyst has no way of being certain that the years chosen for a sample will present an adequate picture of an individual's citation record, without compiling a citation record over a substantial portion of the entire professional life of a scientist.

f. Cronyism: A Possible Future Problem

If citation analysis becomes an accepted, universal method of evaluating research utilization, scientists may conspire with their colleagues to cite one another to effect an increase in their individual citation counts. If such "cronyism" becomes a widespread practice the total number of citations will increase. If cronyism grows uniformly, comparing an individual to the universe of scientists will not imply any inflated influence. The problem will arise if cronyism occurs only in isolated instances. In an isolated instance, citation counts will be highly inflated, leading to overestimates of the influence the scientist has in his field. When compiling citation counts, no way now exists to determine either the degree to which cronyism exists or the existence of cronyism as a factor in the count.

Scientists perpetrate a more subtle form of cronyism by citing the works they are most familiar with, namely, those of co-workers or former co-workers. For example, a junior scientist seeking the favor of a superior may consistently cite his publications. Once again, determination of the extent to which such cronyism affects citation counts is very difficult.

E. Major Data Bases

Some of the basic considerations in choosing a data base for evaluative bibliometric work are tabulated in this section. It must be stressed that in all the major data bases, with the single exception of the Science Citation Index, a substantial portion of the journals are abstracted selectively, although most data bases have at least a core of journals which they abstract cover-to-cover. This selective abstracting results in

a situation where the different data bases may or may not include the same publications for the same investigators even in their clearly overlapping areas. Furthermore, most of the data bases are not uniformly up to date in their abstracting, so that a substantial number of the publications from the previous year or two may appear in any year's abstracting service.

Although there are thousands of different abstracting and indexing services, the ten listed in Table 6-8¹⁰ include the largest data bases easily accessible to a U.S. scientist and the ones of greatest interest to general evaluative work. For counts and evaluation in more specific and specialized areas the analyst may want to use a specialized data base.

All of the data in the table are for 1974-1975. The information in all of the data bases is available in computer readable form, sometimes from on-line services and sometimes on tapes, or both. The availability of these data bases changes constantly, as do the numbers describing their coverage. The reader should contact the services directly for up to date information.

The table shows that the number of entries in the Science Citation Index appears to be larger than the entries in any of the specialized abstracting and indexing services, including Chemical Abstracts which is the giant among the world's abstracting services. Of course, Chemical Abstracts subject classifies and abstracts many of its entries, thus providing a much larger amount of information about the content of the entries than the Science Citation Index, which provides only indexing and keyword access. Nevertheless, while Chemical Abstracts covers 14,000 journals, six times as many as the SCI, the SCI has data on more articles than Chemical Abstracts. This distinction in scope vividly illustrates the difference between cover-to-cover indexing and selective abstracting.

The table also shows that some of the services contain data on the author's institutional affiliations while other services do not. For evaluative work the lack of data on the institutional affiliation constitutes a severe handicap since institutional analysis provides significant information on productivity and eminence. However, many of the services spell the author's name more completely than the SCI, somewhat easing the individual author identification problem.

¹⁰ For further information on the abstracting services listed, the reader should contact the National Federation of Abstracting and Indexing Services (NFAIS), 3401 Market Street, Philadelphia, Pa., 19104.

TABLE 6-8

CHARACTERISTICS OF MAJOR ABSTRACTING AND INDEXING SERVICES

Service	Fields of Coverage	Journal Coverage	Entries/Year	Author Institution	Type of Publication	Number of References Noted	Indexes & Comments
Bibliography of Agriculture (Since 1937)	Agriculture + Related Science	5,500 Journals	125,000	No	No	Yes	Subject, Author, Institution, Geographic
Biological Abstracts (Since 1926)	Biology and Biomedicine	8,000 Journals	240,000	Yes	No	No	Subject, Author, Biosystem-atic,
Chemical Abstracts (Since 1907)	Chemistry and Related Fields	14,000 Journals	350,000	1st Author	No	No	Keyword, Patent, Author, Subject, Chemical Formula
Engineering Index (Since 1884)	Engineering and Related Fields	2,000 Journals	85,000	1st Author	No	Yes	Author, Affiliation
Excerpta Medica (Since 1947)	Chemical and Basic medical	3,500 Journals	200,000	No	No	Yes	Subject & Author
Index Medicus (Since 1960)	Biomedical Journal Literature	2,200 cover-to-cover 16,000 Selectively	220,000	No	No	Yes	Subject & Author
Physics Abstracts (Since 1897)	Physics and Related Fields	130 cover-to-cover 2,200 Selectively	85,000	Occasionally	No	Yes	Subject & Author

TABLE 6-8 (Continued)

CHARACTERISTICS OF MAJOR ABSTRACTING AND INDEXING SERVICES

Service	Fields of Coverage	Journal Coverage	Entries/Year	Author Institution	Type of Publication	Number of References Noted	Indexes & Comments
Psychological Abstracts (Since 1927)	Psychology & Fields	800	25,000	1st Author	No	Yes	Subject & Author
Science Citation Index (Since 1961)	Physical, Biological, Engineering Sciences	2,400 cover-to-cover	400,000	Yes	Yes	Yes	Citation, Author, Institution Keyword
Social Science Citation Index (Since 1971)	Social Sciences + Humanities	1,300 Selectively 1,300 cover-to-cover	85,000	Yes	Yes	Yes	Citation, Author, Institution Keyword

Note: All Services include standard bibliographic data (author(s) names, article title, journal name, volume, page, year).
All Services are international in scope.

Most of the services do not differentiate between forms of publications, although many of them concentrate heavily on the abstracting of regular articles and may not have as much need to note the form of publication as the SCI which includes articles, letters, notes, reviews, meeting abstracts, and so forth.

A number of the services note how many references there are in an article, even though no services except for the SCI and the SSCI actually contain the references. The number of references is of interest, since in most fields publications which do not contain references are not scientific articles in the normal sense.

Virtually all of the services have subject and author indexes, and a few have institutional and other specialized indexes. The only services that have a citation index are, of course, the SCI and the SSCI.

There do not seem to be any simple, firm rules to aid the analyst in determining which service he should use as a data source for evaluative work. If the evaluation covers a substantial number of fields in the center of the physical, biological and engineering sciences the SCI has many advantages, because of the breadth of its coverage. For activity in engineering and agriculture and for in-depth coverage of foreign activity outside of the major foreign journals, the SCI is quite limited. Any conclusions based on SCI data for these activity areas must be treated with trepidation. For many analyses, the best procedure is to start with the SCI, and to supplement its coverage with searches through the more specialized sources.

There is an on-going study by the National Federation of Abstracting and Indexing Services (NFAIS) of the overlap between data bases, especially between Chemical Abstracts, Biological Abstracts and the Engineering Index. This work has been reported so far in two publications by J.L. Wood and others;^{11,12} the first of these showed that, "of the 14,592 different journals monitored, in the 1970 time period, 1% were monitored by all three

¹¹James L. Wood, Carolyn Flanagan, and H. Edward Kennedy, "Overlap in the Lists of Journals Monitored by BIOSIS, CAS, and EI," Journal of the American Society for Information Science 24 (January-February 1972):36-38.

¹²James L. Wood, "Overlap Among Journal Articles Selected for Coverage by BIOSIS, CAS, and EI," Journal of the American Society for Information Science 25 (January-February 1973): 25-58.

of the services, 27% were monitored by two of the services, and 72% were monitored by only one of the three services."¹³ The second of these articles showed that there were some 50,000 articles abstracted by both Biological Abstracts and Chemical Abstracts between 1 July 1969 and 30 June 1970, out of a total number of journal articles abstracted of approximately 170,000 from Biological Abstracts and approximately 190,000 for Chemical Abstracts. Thus, these two major services have some 25% of their articles in common, while at least 75% of the articles abstracted by either service are not covered by the other. NFAIS is now looking at the overlap between these services and a number of the other major services.

Overall, the data base problem in evaluative bibliometrics is far more a problem of precision than of access. The data are there; the true difficulties lie in the uniform collection, evaluation and interpretation of the data.

F. Field Dependent Characteristics of the Scientific Literature

This section provides basic data to characterize publication and citation patterns in the major fields and subfields of science.

All of this data is based on approximately 3,325,000 references from 2,250 journals in the 1973 Science Citation Index to the same 2,250 journals in the Science Citation Index. All references to journals or other publications not covered by the SCI have been excluded from this data, as have 150 multi-field journals. Thus references to books, which tend to have somewhat earlier dates than references to journals are not included in these counts. The fields are constructed by aggregating the journals assigned to them. These journal assignments are listed individually by field and subfield in Appendix I.

Note that the publication counts used to generate the citation/publication data are counts of the number of articles, notes and reviews in the 1973 Corporate Tapes of the Science Citation Index, while the citation counts are citations to all previous years. If a journal has grown rapidly the citation/publication count should be somewhat higher than the figures presented here, since the publication counts should be the average number of publications in that journal in previous cited years rather than just in 1973. Most fields have been growing at an average rate of perhaps 5% per year for the past few years, and substantially more rapidly in the previous five to ten years; thus, the individual citation/publication figures, on an age-adjusted basis, would probably be at least 25% higher. The relative differences between fields would probably not be affected much.

¹³Wood, Flanagan, and Kennedy, "Overlap in the Lists of Journals Monitored by BIOSIS, CAS, and EI," p. 36.

Some publications covered by the SCI do not appear in the Corporate Tapes because of a lack of a corporate author. Approximately 88% of the 258,000 publications are articles, while 11% are notes and the remaining 1% are reviews. For all of the entries in the 1973 Corporate Tapes of the SCI, Table 6-9 lists the breakdown by type of publication (ISI's k-code).

1. References and Citations

Table 6-10 summarizes a set of reference and citation counts for 1973 SCI.

Distinct differences appear between the fields. Engineering and technology, and mathematics have low reference and citation/publication counts, in the range of 5 to 6. Psychology and biology form a second group, with 8 to 10 references and citations/publication. The next group contains earth and space science, physics, chemistry, and clinical medicine, all with 12 to 15 references and citations/publication. Finally, the field of biomedical research has substantially higher referencing and citation counts: between 18 and 20 per publication.

The next section of the table shows this data on a subfield by subfield basis. Each subfield is defined as the collection of journals under that heading in Appendix I. The subfields which appear to have more than 20 references/publication are physiology, embryology, biochemistry and molecular biology, cell biology, and cytology and histology.

2. Time Distributions and Growth Rates

The time distributions of references from any given year and the rate of growth of a given literature are intimately connected, since the fraction of the publications from more recent years would be increasing in a rapidly growing field. As a result, the average reference in such a field would tend to be a relatively recent publication. This reference time area has been of interest to librarians and information scientists, since such information helps to evaluate the utility of back issues of scientific periodicals.

A recent paper by Line and Sandison¹⁴ summarizes and contains data on 200 papers which deal with obsolescence, use and time distribution of references in different literatures. The rate of growth of science and its relationship to literature indicators is discussed at length in a book by Menard.¹⁵

¹⁴Maurice B. Line and A. Sandison, "Obsolescence and Changes in the Use of Literature with Time," Journal of Documentation 30 (September 1974):283-350.

¹⁵Henry W. Menard, Science: Growth and Change, Cambridge, Mass.: Harvard University Press, 1971.

TABLE 6-9

PUBLICATION TYPE TABULATION FROM 1973 CORPORATE INDEX

Type of Publication	% of Publications of this Type	# of Publications of this Type
Articles	68.43	246,392.
Letters	3.87	13,928.
Notes	8.29	29,836.
Reviews	0.90	3,251.
Meetings	17.17	61,840.
Others	1.34	4,834.
	TOTAL	360,081.

TABLE 6-10

FIELD AND SUBFIELD PUBLICATION AND REFERENCE COUNTS*

Field	Number of Journals	Number of Publications	Number of References	Number of Citations	Reference/ Publication	Citation/ Publication
Engineering & Technology	428	27718.	161848.	135026.	5.84	4.87
Biomedical Research	275	33231.	614051.	664030.	18.48	19.98
Psychology	91	7178.	70171.	63652.	9.78	8.87
Biology	294	22634.	224485.	177253.	9.92	7.83
Mathematics	90	7254	38155.	44472.	5.26	6.13
Earth & Space	115	10042.	120820.	113293.	12.33	11.28
Physics	123	33189.	416410.	464182.	12.55	13.99
Chemistry	186	42265.	588346.	571840.	13.92	13.53
Clinical Medicine	644	74830.	1090663.	974899.	14.58	13.03
All Fields	2246	258341.	3324949.	3208647.	12.80	12.40
Subfield						
Genrl & Internal Med	99	15686.	243900.	262200.	15.55	16.72
Allergy	6	425.	6493.	5521.	15.28	12.99
Anesthesiology	8	914.	13170.	8876.	14.41	9.71
Cancer	17	2607.	47655.	41217.	18.28	15.81
Cardiovascular System	23	2459.	46164.	47630.	18.77	19.37
Dentistry	20	1830.	17952.	14097.	9.81	7.70
Dermat & Venerl Dis	11	1303.	17814.	14104.	13.67	10.82
Endocrinology	18	2720.	49510.	52119.	18.20	19.16
Fertility	5	705.	10487.	6856.	14.88	9.72
Gastroenterology	14	1239.	23206.	16691.	18.73	13.47
Geriatrics	10	533.	5881.	2763.	11.03	5.18
Hematology	12	1112.	19276.	18305.	17.33	16.46
Immunology	28	3847.	66772.	63349.	17.30	16.47
Obstetrics & Gynecol	12	1502.	19263.	15624.	12.82	10.40
Neurol & Neurosurg	37	4263.	77006.	61348.	18.06	14.39
Ophthalmology	17	1788.	21152.	17214.	11.83	9.63
Orthopedics	8	1009.	10250.	9398.	10.10	9.31
Arthritis & Rheumat	5	315.	4835.	4404.	15.35	13.98
Otorhinolaryngology	10	980.	10773.	8192.	10.99	8.36
Pathology	21	2178.	38092.	36133.	17.49	16.59
Pediatrics	19	2259.	33950.	28794.	15.03	12.75
Pharmacology	49	5881.	94828.	72164.	16.12	12.27

TABLE 6-10 (Continued)

FIELD AND SUBFIELD PUBLICATION AND REFERENCE COUNTS*

Subfield	Number of Journals	Number of Publications	Number of References	Number of Citations	Reference/ Publication	Citation/ Publication
Pharmacy	23	3175.	37502.	19083.	11.81	6.01
Psychiatry	32	1541.	15147.	14047.	9.83	9.12
Radiology & Nucl Med	30	3325.	36263.	30849.	10.91	9.28
Respiratory System	8	875.	12067.	8447.	13.79	9.65
Surgery	36	4496.	50629.	49909.	11.29	11.13
Tropical medicine	6	478.	5413.	5616.	11.32	11.75
Urology	7	926.	8919.	7471.	9.63	8.07
Nephrology	2	189.	4592.	827.	24.30	4.38
Veterinary Medicine	23	2232.	23441.	14331.	10.50	6.42
Addictive Diseases	4	203.	2311.	1403.	11.38	6.91
Hygiene & Publ Hlth	19	1494.	12211.	13998.	8.17	9.37
Misc Clinical Med	5	351.	3739.	1919.	10.65	5.47
Physiology	21	2455.	57761.	88905.	23.53	36.21
Anatomy & Morphology	9	603.	11933.	15536.	19.79	25.76
Embryology	8	611.	12667.	6800.	20.73	11.13
Genetics & Heredity	37	2707.	40952.	31586.	15.13	11.67
Nutrition & Dietet	14	1019.	17986.	11752.	17.65	11.53
Biochem & Molec Biol	54	12706.	264531.	322438.	20.82	25.38
Biophysics	12	690.	11642.	5144.	16.87	7.46
Cell Biol Cyt & Hist	30	3208.	68618.	72880.	21.39	22.72
Microbiology	22	3108.	51191.	42386.	16.47	13.64
Virology	7	1406.	25085.	21056.	17.84	14.98
Parasitology	9	916.	10013.	8627.	10.93	9.42
Biomedical Engineering	10	607.	5029.	2701.	8.29	4.45
Microscopy	6	372.	4812.	2577.	12.94	6.93
Misc Biomedical Res	19	1154.	8842.	5045.	7.66	4.37
Genl Biomedical Res	17	1669.	22989.	26597.	13.77	15.94
General Biology	7	290.	3499.	4389.	12.07	15.13
General Zoology	15	638.	10537.	9544.	16.52	14.96
Entomology	24	2039.	16602.	13671.	8.14	6.70
Miscellaneous Zool	19	1920.	22797.	15163.	11.87	7.90
Marine Bio & Hydrobl	14	1408.	13469.	10411.	9.57	7.39
Botany	74	5864.	70628.	57890.	12.04	9.87
Ecology	19	1041.	10805.	11012.	10.38	10.58
Agricult & Food Sci	93	7131.	53257.	37639.	7.47	5.28
Dairy & Anima! Sci	16	1808.	17395.	14180.	9.62	7.84

TABLE 6-10 (Continued)

FIELD AND SUBFIELD PUBLICATION AND REFERENCE COUNTS*

Subfield	Number of Journals	Number of Publications	Number of References	Number of Citations	Reference/ Publication	Citation/ Publication
Miscellaneous Biol	8	495.	5496.	3354.	11.10	6.78
Analytical Chemistry	17	3852.	44570.	44116.	11.57	11.45
Organic Chemistry	15	6060.	87885.	64036.	14.50	10.57
Inorganic & Nucl Chm	7	2515.	36387.	29556.	14.47	11.75
Applied Chemistry	31	2845.	34691.	30424.	12.19	10.69
General Chemistry	61	16108.	253485.	279837.	15.74	17.37
Polymers	13	3269.	36661.	28022.	11.21	8.57
Physical Chemistry	42	7616.	94667.	95849.	12.43	12.59
Chemical Physics	6	3254.	51276	75383.	15.76	23.17
Solid State Physics	5	3909.	43217.	28136.	11.06	7.20
Fluids & Plasmas	6	888.	9218.	10193.	10.38	11.48
Applied Physics	32	6228.	52981.	51813.	8.51	8.32
Acoustics	9	989.	8219.	7836.	8.31	7.92
Optics	15	1236.	15376.	16257.	12.44	13.15
General Physics	42	14790.	199926.	245076.	13.52	16.57
Nucl & Particle Phys	2	1273.	30439.	23953.	23.91	18.82
Miscellaneous Phys	6	622.	5758.	5535.	9.26	8.90
Astronomy & Astrophys	21	3179.	43718.	40499.	13.75	12.74
Meteorol & Atmos Sci	11	613.	5239.	5076.	8.55	8.28
Geology	25	1914.	21329.	21999.	11.14	11.49
Earth & Plantry Sci	36	3619.	45131.	40510.	12.47	11.19
Geography	1	23.	106.	102.	4.61	4.43
Oceanography & Limno	21	694.	5297.	5107.	7.63	7.36
Chemical Engineering	34	2585.	15831.	14481.	6.12	5.60
Mechanical Engineer	44	3078.	14541.	10036.	4.72	3.26
Civil Engineering	21	1097.	6209.	3866.	5.66	3.52
Electr Eng & Elctron	72	6489.	38959.	34298.	6.00	5.29
Misc Eng & Technol	11	228.	163.	244.	0.71	1.07
Industrial Engineer	1	67.	10.	214.	0.15	3.19
General Engineering	30	1325.	5330.	3190.	4.02	2.41
Metals & Metallurgy	56	4854.	36466.	32494.	7.51	6.69
Materials Science	57	2666.	15978.	13015.	5.99	4.88
Nuclear Technology	27	1816.	13709.	9469.	7.55	5.21
Aerospace Technology	17	1071.	3771.	4021.	3.52	3.75
Computers	30	1393.	7323.	6929.	5.26	4.97
Library & Info Sci	21	603.	2060.	1686.	3.42	2.80

TABLE 6-10 (Continued)
FIELD AND SUBFIELD PUBLICATION AND REFERENCE COUNTS*

Subfield	Number of Journals	Number of Publications	Number of References	Number of Citations	Reference/ Publication	Citation/ Publication
Op Res & Managmt Sci	7	446.	1498.	1083.	3.36	2.43
Clinical Psychology	6	566.	4114.	5893.	7.27	10.41
Personality & Soc Ps	10	785.	6167.	5741.	7.86	7.31
Devel & Child Psycho	6	342.	3471.	3123.	10.15	9.13
Experimental Psychol	12	1929.	18130.	19569.	9.40	10.14
General Psychology	29	1583.	17352.	16246.	10.96	10.26
Misc Psychology	16	721.	5620.	3818.	5.79	5.30
Behavioral Science	12	1252.	15317.	9262.	12.23	7.40
Probability & Statist	18	1242.	6949.	9984.	5.60	8.04
Applied Mathematics	21	1389.	7768.	8441.	5.59	6.08
General Mathematics	46	4301.	21698.	24525.	5.04	5.70
Misc Mathematics	5	322.	1740.	1522.	5.40	4.73

*Articles, notes, reviews in 1973 Corporate Tapes of SCI, with multi-field journals omitted, counting only references and journals within the SCI journal set.

Table 6-11 shows SCI based reference time distributions for the major fields, while Figure 6-10 plots the same data. Note that in almost all fields the references from 1973 peak in 1971, with the exceptions of psychology and mathematics where the peak cited year is 1970.

The figure shows that psychology, mathematics and biology are the three fields with the longest reference time lags. The field of earth and space science seems to have a particularly high citation peak in 1971, which may be due to a relatively rapid recent growth of that field.

Table 6-12 summarizes these data somewhat differently, by tabulating the percent of references to the first four years (1970 through 1973 inclusive). From this table, earth and space science and physics appear to be the two fields with the largest "immediacy". Mathematics is somewhat off by itself, with psychology and biology the fields of least rapid referencing.

3. Concentration

Another interesting characteristic of the different fields is the concentration of publication and influence within the journals. Some fields, for example, have a few exceedingly large central journals while other fields have their publications dispersed throughout a larger number of journals.

The data on the number of publications in each field, subfield, and journal are contained in Appendix I. This discussion summarizes the differences between the major fields, including detailed data only on the field of physics.

Table 6-13 shows the fifty largest and the fifty most influential physics journals. In this case, size is measured by number of publications--articles, notes and reviews counted equally. Influence in this table is total influence, which is the number of publications in the journal multiplied by the average influence/publication. Average influence/publication is defined in the next chapter. At this point, the measure serves mainly to illustrate the point that the different fields are even more concentrated in influence than they are in publications.

Note that a single journal, the Physical Review, contains almost 11% of the physics publications covered by the SCI and more than 23% of the total influence for physics. These percentages indicate that, on the average, an article in the Physical Review receives a weighted number of citations which is twice that of the average for other physics journals. Physics is an exceedingly highly concentrated field. More than half of

TABLE 6-11
REFERENCE TIME DISTRIBUTIONS FOR MAJOR FIELDS

FIELD	Number of P E R C E N T O F A L L 1 9 7 3 R E F E R E N C E S W H I C H R E F E R T O B e f o r e															
	1973 Refs	1972	1971	1970	1969	1968	1967	1966	1965	1964	1963	1962	1961	1960	1960	
CLINICAL MEDICINE	1090663.	1.99	9.13	11.80	10.35	8.93	7.67	6.64	5.63	4.76	4.10	3.45	2.93	2.56	2.21	17.85
BIOMEDICAL RESEARCH	614051.	2.00	10.00	12.76	10.99	9.65	8.08	6.82	5.56	4.76	3.97	3.38	2.68	2.33	2.00	15.02
BIOLOGY	224485.	1.51	6.68	9.65	9.17	8.48	7.27	6.62	5.60	4.83	4.32	3.73	3.11	2.79	2.58	23.67
CHEMISTRY	588346.	2.06	9.81	11.43	9.46	8.01	7.38	6.11	5.18	4.87	4.06	3.52	2.94	2.60	2.30	20.25
PHYSICS	416410.	3.09	12.31	13.07	10.71	9.33	7.75	6.68	5.41	4.65	3.80	3.14	2.70	2.15	2.00	13.21
EARTH & SPACE	120820.	2.72	11.56	14.03	12.21	10.31	8.01	6.47	4.92	4.09	3.41	2.81	2.35	1.97	1.77	13.36
ENGINEERING & TECHNOLOGY	161848.	2.72	10.53	10.96	9.68	8.54	7.23	6.49	5.30	4.69	3.91	3.39	2.90	2.57	2.38	18.71
PSYCHOLOGY	70171.	1.14	5.75	10.20	10.41	10.30	8.65	7.13	6.77	5.58	4.45	4.04	3.45	2.68	2.24	17.22
MATHEMATICS	38155.	1.35	6.72	9.22	9.41	8.35	6.97	6.04	5.31	4.84	4.10	3.28	3.13	2.81	2.80	25.67

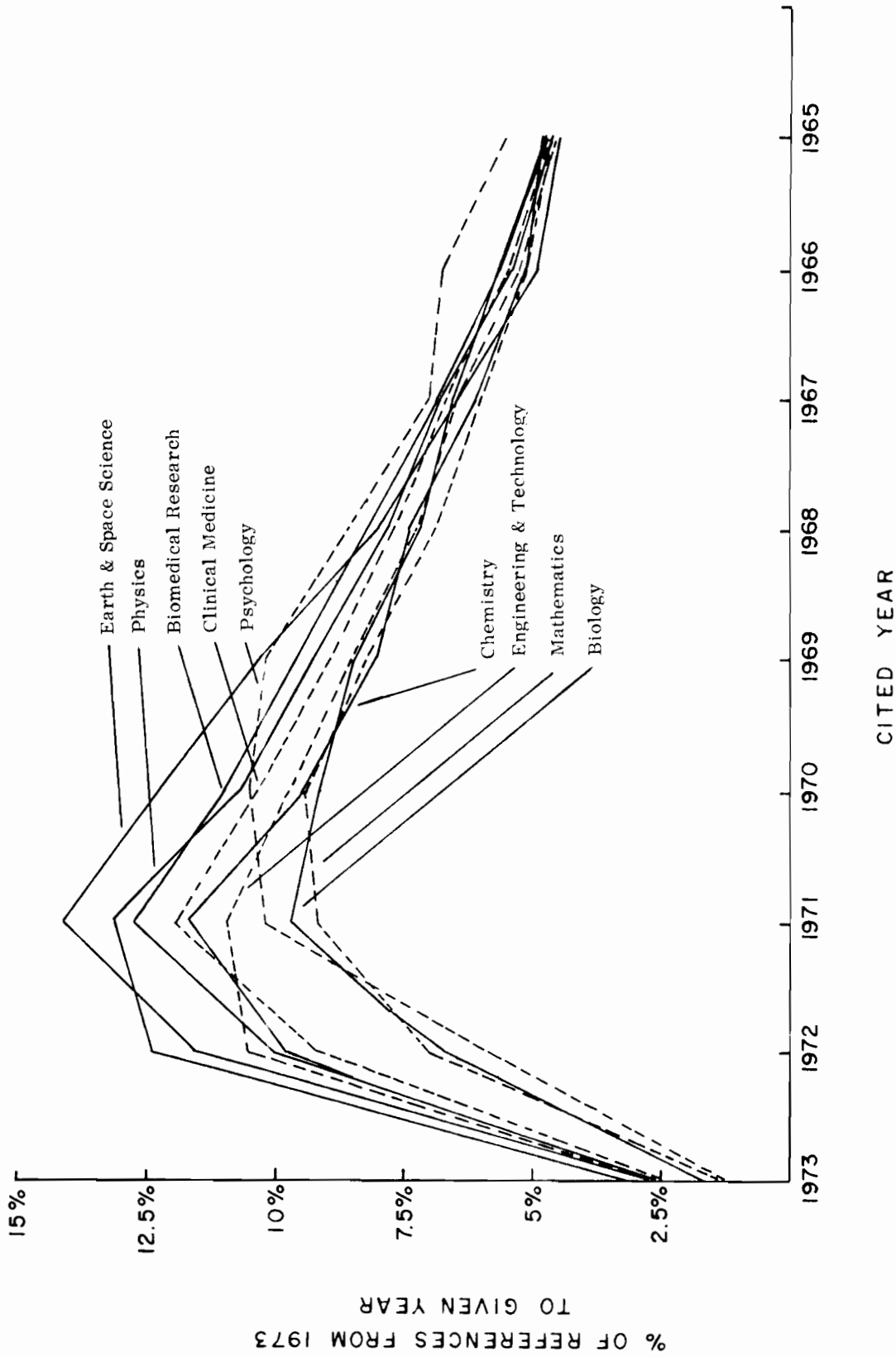

FIGURE 6-10

REFERENCE TIME DISTRIBUTION FOR 1973

TABLE 6-12

IMMEDIACY OF REFERENCING FOR MAJOR FIELDS

Field	% of Total 1973 References to 1970 through 1973
Earth & Space Science	40.52
Physics	39.18
Biomedical Research	35.75
Engineering & Technology	33.89
Clinical Medicine	33.27
Chemistry	32.76
Mathematics	26.70
Psychology	20.50
Biology	20.01

TABLE 6-13

FIFTY LARGEST, AND FIFTY MOST INFLUENTIAL, PHYSICS JOURNALS

Rank	PUBLICATIONS				TOTAL INFLUENCE			
	Journal Name	Number of Publications	% of all Physics Publications	Cumulative % of all Physics Publications	Journal Name	Total Influence	% of Total Influence in Physics	Cumulative % of Total Influence in Physics
1	PHYS REV	3648	10.99	10.99	PHYS REV	96307	23.47	23.47
2	J PHYS	1672	5.04	16.03	J CHEM PHYS	35925	8.76	32.23
3	PHYS LETT	1622	4.89	20.92	PHYS REV L	34185	8.33	40.56
4	PHYS ST SOL	1496	4.51	25.42	NUCL PHYS	24446	5.96	46.51
5	J CHEM PHYS	1448	4.36	29.79	PHYS LETT	19578	4.77	51.28
6	NUCL PHYS	1209	3.64	33.43	SOV PH JE R	14902	3.63	54.92
7	J APPL PHYS	1051	3.17	36.60	J APPL PHYS	14619	3.56	58.48
8	CHEM P LETT	969	2.92	39.52	CHEM P LETT	13895	3.39	61.87
9	SOV PH SS R	905	2.73	42.24	J PHYS	12908	3.15	65.01
10	PHYS REV L	897	2.70	44.95	APPL PHYS L	6748	1.64	66.66
11	P M S JAP	820	2.47	47.42	NUOV CIM	6425	1.57	68.22
12	SOL ST COMM	777	2.34	49.76	P M S JAP	6257	1.52	69.75
13	NUCL INSTR	627	1.89	51.65	PHLOS MAG	5673	1.38	71.13
14	LETT NUOV C	609	1.83	53.48	Z PHYS	5529	1.35	72.48
15	SOV PH JE R	598	1.80	55.28	PHYS ST SOL	5505	1.34	73.82
16	PRIB TEKH	537	1.62	56.90	J OPT SOC	5464	1.33	75.15
17	APPL PHYS L	498	1.50	58.40	J ACCOUST SO	5250	1.28	76.43
18	SOV PH SE R	479	1.44	59.85	J PHYS CH S	5078	1.24	77.67
19	NUOV CIM	449	1.35	61.20	PHYS FLUIDS	5014	1.22	78.89
20	IVUZ FIZ	435	1.31	62.51	REV M PHYS	4424	1.08	79.97
21	REV SCI INS	434	1.31	63.82	SOV PH SS R	4308	1.05	81.02
22	JAP J A PHY	433	1.30	65.12	JETP LETTER	4268	1.04	82.06
23	APPL OPTICS	430	1.30	66.42	ANN PHYSICS	4256	1.04	83.09
24	PROG T PHYS	396	1.19	67.61	REV SCI INS	4127	1.01	84.10
25	SOV PH TP R	367	1.11	68.72	J MATH PHYS	4092	1.00	85.10

TABLE 6-13 (Continued)

FIFTY LARGEST, AND FIFTY MOST INFLUENTIAL, PHYSICS JOURNALS

Rank	PUBLICATIONS				TOTAL INFLUENCE			
	Journal Name	Number of Publications	% of all Physics Publications	Cumulative % of all Physics Publications	Journal Name	Total Influence	% of Total Influence in Physics	Cumulative % of Total Influence in Physics
26	PHYS FLUIDS	362	1.09	69.81	CAN J PHYS	3898	0.95	86.05
27	J ACOUST SO	350	1.05	70.86	PROG T PHYS	3711	0.90	86.95
28	JETP LETTER	349	1.05	71.91	SOL ST COMM	3675	0.90	87.85
29	I J PA PHYS	348	1.05	72.96	NUCL INSTR	3593	0.88	88.72
30	Z PHYS	346	1.04	74.00	PHYSICA	3433	0.84	89.56
31	CAN J PHYS	339	1.02	75.02	APPL OPTICS	3337	0.81	90.37
32	SURF SCI	324	0.98	76.00	J FLUID MEC	3092	0.75	91.13
33	AM J PHYS	323	0.97	76.97	SOV J NUC R	2637	0.64	91.77
34	SOV J NUC R	315	0.95	77.92	SURF SCI	2077	0.51	92.27
35	PHYSICA	309	0.93	78.85	J PHYSIQUE	1887	0.46	92.73
36	J MATH PHYS	290	0.87	79.73	SOV PH TP R	1809	0.44	93.18
37	MOLEC PHYS	289	0.87	80.60	MOLEC PHYS	1780	0.43	93.61
38	HIGH TEMP R	263	0.79	81.39	IEEE J Q EL	1730	0.42	94.03
39	J PHYS CH S	252	0.76	82.15	LETT NUOV C	1583	0.39	94.42
40	THIN SOL FI	248	0.75	82.90	ADV PHYSICS	1545	0.38	94.79
41	REP NRL PRO	241	0.73	83.62	COMM MATH P	1286	0.31	95.11
42	J FLUID MEC	236	0.71	84.34	JAP J A PHY	1074	0.26	95.37
43	J OPT SOC	232	0.70	85.03	SOV PH SE R	944	0.23	95.60
44	PHILOS MAG	228	0.69	85.72	AM J PHYS	924	0.23	95.82
45	CZEC J PHYS	193	0.58	86.30	HELV PHYS A	918	0.22	96.05
46	J SOUND VIB	191	0.58	86.88	REP PR PHYS	917	0.22	96.27
47	J MAGN RES	190	0.57	87.45	J VAC SCI T	883	0.22	96.49
48	HELV PHYS A	180	0.54	87.99	ANN PHYSIK	842	0.21	96.69
49	J L TEMP PH	174	0.52	88.52	USP FIZ NAU	806	0.20	96.89
50	IEEE J Q EL	159	0.48	89.00	J L TEMP PH	696	0.17	97.06

the SCI covered physics publications are contained in only thirteen journals while more than half of the total influence of the physics publication is contained in only five journals.

Figure 6-11 plots the concentration of the publications in the journals for the major fields. The figure shows that the four fields of physics, mathematics, psychology and earth and space science form a concentrated group, while clinical medicine is dispersed.

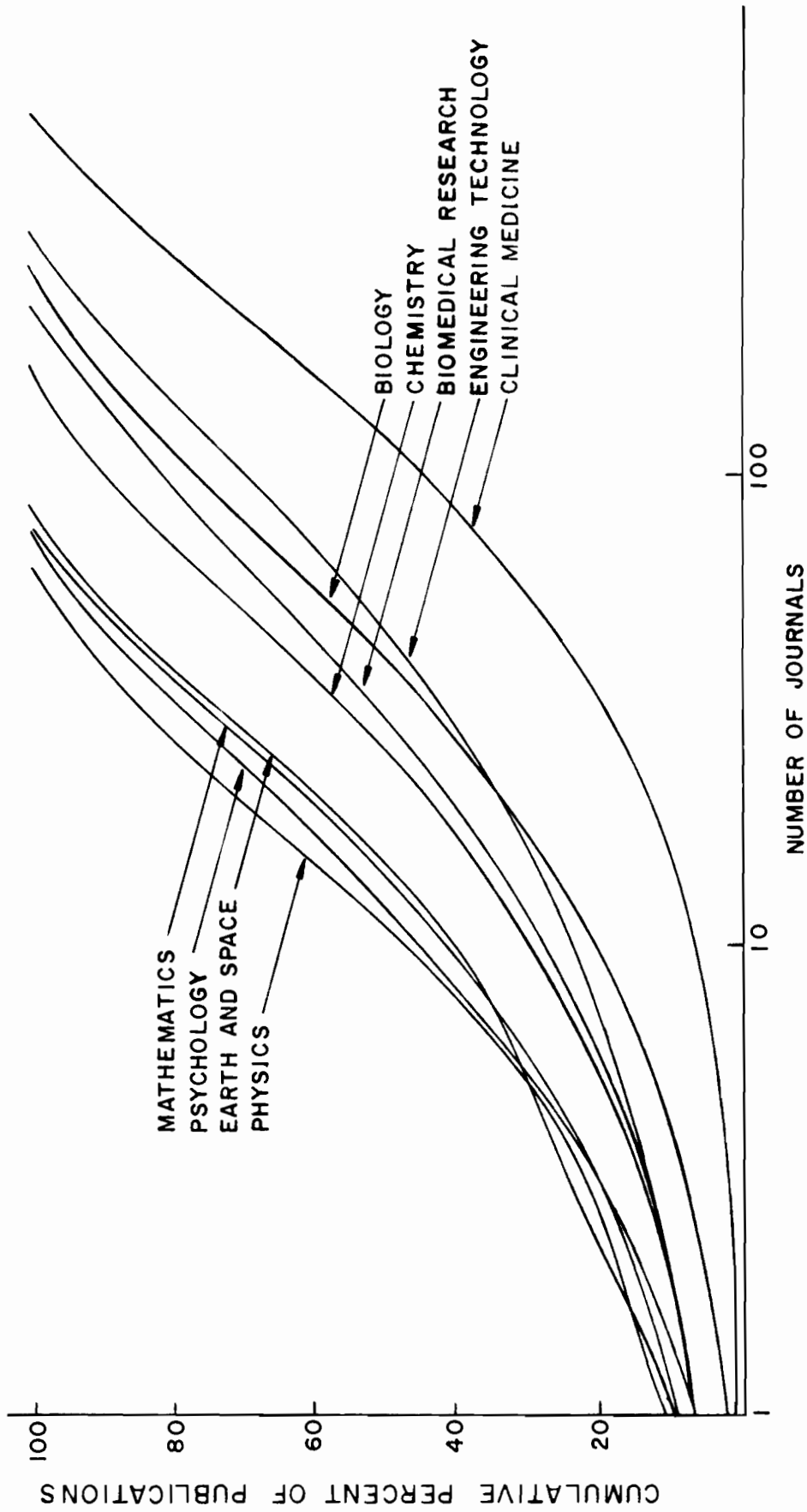

FIGURE 6-11

CONCENTRATION OF PUBLICATIONS IN JOURNALS FOR MAJOR FIELDS

VII. THE INFLUENCE METHODOLOGY

A. Introduction

In this chapter an influence methodology will be described which allows advanced publication and citation techniques to be applied to institutional aggregates of publications, such as those of departments, schools, programs, support agencies and countries, without performing an individual citation count. In essence, the influence procedure ascribes a weighted average set of properties to a collection of papers, such as the papers in a journal, rather than determining the citation rate for the papers on an individual basis.

The influence methodology is completely general, and can be applied to journals, subfields, fields, institutions or countries.

There are three separate aspects of the influence methodology which are particularly pertinent to journals. These are

1. A subject classification for each journal
2. A research type (level) classification for the biomedical journals, and
3. Citation influence measures for each journal.

It is the third of these, the citation influence measures, which add a quality or utilization aspect to the analysis. The influence methodology assumes that, although citations to papers vary within a given journal, aggregates of publications can be characterized by the influence measures of the journals in which they appear. Chapter IX discusses this assumption in some detail.

Older measures of influence all suffer from some defect which limits their use as evaluative measures.

The total number of publications of an individual, school or country is a measure of total activity only; no inferences concerning importance may be drawn.

The total number of citations to a set of publications, while incorporating a measure of peer group recognition, depends on the size of the set involved and has no meaning on an absolute scale.

The journal "impact factor" introduced by Garfield is a size-independent measure, since it is defined as the ratio of the number of citations the journal receives to the number of publications in a specified earlier time period.¹ This

¹Eugene Garfield, "Citation Analysis As a Tool in Journal Evaluation," Science 178 (November 3, 1972):471.

measure, like the total number of citations, has no meaning on an absolute scale. In addition the impact factor suffers from three more significant limitations. Although the size of the journal, as reflected in the number of publications, is corrected for, the average length of individual papers appearing in the journal is not. Thus, journals which publish longer papers, namely review journals, tend to have higher impact factors. In fact the nine highest impact factors obtained by Garfield were for review journals. This measure can therefore not be used to establish a "pecking order" for journal prestige.

The second limitation is that the citations are unweighted, all citations being counted with equal weight, regardless of the citing journal. It seems more reasonable to give higher weight to a citation from a prestigious journal than to a citation from a peripheral one. The idea of counting a reference from a more prestigious journal more heavily has also been suggested by Kochen.²

A third limitation is that there is no normalization for the different referencing characteristics of different segments of the literature: a citation received by a biochemistry journal, in a field noted for its large numbers of references and short citation times, may be quite different in value from a citation in astronomy, where the overall citation density is much lower and the citation time lag much longer.

In this section three related influence measures are developed, each of which measures one aspect of a journal's influence, with explicit recognition of the size factor. These measures are:

- (1) The influence weight of the journal: a size-independent measure of the weighted number of citations a journal receives from other journals, normalized by the number of references the journal gives to other journals.
- (2) The influence per publication for the journals: the weighted number of citations each article, note or review in a journal receives from other journals.
- (3) The total influence of the journal: the influence per publication times the total number of publications.

²M.Kochen, Principles of Information Retrieval, (New York: John Wiley & Sons, Inc. 1974), 83.

B. Development of the Weighting Scheme

1. The Citation Matrix

A citation matrix may be used to describe the interactions among members of a set of publishing entities. These entities may, for example, be journals, institutions, individuals, fields of research, geographical subdivisions or levels of research methodology. The formalism to be developed is completely general in that it may be applied to any such set. To emphasize this generality, a member of a set will be referred to as a unit rather than as a specific type of unit such as a journal.

The citation matrix is the fundamental entity which contains the information describing the flow of influence among units.

The matrix has the form

$$C = \begin{pmatrix} C_{11} & C_{12} & \dots & C_{1n} \\ C_{21} & C_{22} & \dots & C_{2n} \\ \cdot & \cdot & & \cdot \\ \cdot & \cdot & & \cdot \\ \cdot & \cdot & & \cdot \\ C_{n1} & C_{n2} & \dots & C_{nn} \end{pmatrix}$$

A distinction is made between the use of the terms "reference" and "citation" depending on whether the issuing or receiving unit is being discussed. Thus, a term C_{ij} in the citation matrix indicates both the number of references unit i gives to unit j and the number of citations unit j receives from unit i .

The time frame of a citation matrix must be clearly understood in order that a measure derived from it be given its proper interpretation. Suppose that the citation data are based on references issued in 1973. The citations received may be to papers in any year up through 1973. In general, the papers issuing the references will not be the same as those receiving the citations. Thus, any conclusions drawn from such a matrix assume an on-going, relatively constant nature for each of the units. For instance, if the units of study are journals, it is assumed that they have not changed in size relative to each other and represent a constant subject area. Journals in rapidly changing fields and new journals would therefore have to be treated with caution.

A citation matrix for a specific time lag may also be formulated. This would link publications in one time period with publications in some specified earlier time period.

2. Influence Weights

For each unit in the set a measure of the influence of that unit will be extracted from the citation matrix. Because total influence is clearly a size-dependent quantity, it is essential to distinguish between a size-independent measure of influence, to be called the influence weight, and the size-dependent total influence.

To make the idea of a size-independent measure more precise, the following property of such a measure may be specified: if a journal were randomly subdivided into smaller entities, each entity would have the same measure as the parent journal.

The citation matrix may be thought of as an "input-output" matrix with the medium of exchange being the citation. Each unit gives out references and receives citations; it is above average if it has a "positive citation balance", i.e., receives more than it gives out. This reasoning provides a first order approximation to the weight of each unit, which is

$$w_i^{(1)} = \frac{\text{total number of citations to the } i\text{th unit from other units}}{\text{total number of references from the } i\text{th unit to other units}}$$

This is the starting point for the iterative procedure for the calculation of the influence weights to be described below.

The denominator of this expression is the row sum

$$S_i = \sum_{j=1}^n C_{ij}$$

corresponding to the i th unit of the citation matrix; it may be thought of as the "target size" which this unit presents to the referencing world.

The influence weight, w_i , of the i th unit is defined as

$$w_i = \sum_{k=1}^n \frac{w_k C_{ki}}{S_i}$$

In the sum, the number of cites to the i th unit from the k th unit is weighted by the weight of k th (referencing) unit. The number of cites is also divided by the target size S_i of

the unit i being cited. The n equations, one for each unit, provide a self consistent "bootstrap" set of relations in which each unit plays a role in determining the weight of every other unit. The following summarizes the derivation of those weights.

The equations defining the weights,

$$w_i = \sum_{k=1}^n \frac{w_k c_{ki}}{s_i}, \quad i = 1, \dots, n \quad (1)$$

are a special case of a more general system of equations which may be written in the form

$$\left\{ \sum_{k=1}^n w_k \gamma_{ki} \right\} - \lambda w_i = 0, \quad i = 1, \dots, n \quad (2)$$

Here $\gamma_{ki} = \frac{c_{ki}}{s_i}$ and Equation 1 is shown to be

a special case of Equation 2 corresponding to $\lambda = 1$. As will be explained shortly the system of equations given in (1) will not, in general, possess a non-zero solution; only for certain values of λ called the eigenvalues of the system, will there be non-zero solutions.

With the choice of target size s_i , the value $\lambda = 1$ is in fact an eigenvalue so that Equation 1 itself does possess a solution.

Using the notation γ^T for the transpose of γ ,

$$\gamma_{ik}^T = \gamma_{ki}; \text{ introducing the Kronecker delta symbol}$$

defined by
$$\delta_{ik} = \begin{cases} 1 & i = k \\ 0 & i \neq k \end{cases}$$

the equation can then be written

$$\sum_{k=1}^n (\gamma_{ik}^T - \lambda \delta_{ik}) w_k = 0 \quad (3)$$

This is a system of n homogeneous equations for the weights. In order that a solution for such a system exists, the determinant of the coefficients must vanish. This gives an n th order equation for the eigenvalues

$$\begin{vmatrix} \gamma_{11} - \lambda & \gamma_{21} & \dots & \gamma_{n1} \\ \gamma_{12} & \gamma_{22} - \lambda & \dots & \gamma_{n2} \\ \vdots & \vdots & \ddots & \vdots \\ \gamma_{1n} & \gamma_{2n} & \dots & \gamma_{nn} - \lambda \end{vmatrix} = 0 \quad (4)$$

called the characteristic equation.

Only for values of λ which satisfy this equation, does a non-zero solution for the w 's exist. Moreover, Equation 3 does not determine the values of the w_k themselves, but at best determines their ratios. Equivalently the eigenvalue equation may be thought of as a vector equation for the vector unknown

$$\underline{w} = \{w_1, \dots, w_n\}$$

$$\underline{\gamma}^T \underline{w} = \lambda \underline{w} \quad (5)$$

from which it is clear that only the direction of \underline{w} is determined.

The normalization or scale factor is then fixed by the condition that the size-weighted average of the weights is 1, or

$$\frac{\sum_{k=1}^n S_k W_k}{\sum_{k=1}^n S_k} = 1 \quad (6)$$

This normalization assures that the weight values have an absolute as well as a relative meaning, with the value 1 representing an average value.

Each root of the characteristic equation determines a solution vector or eigenvector of the equation, but the weight vector being sought is the eigenvector corresponding to the largest eigenvalue. This can be seen from the consideration of an alternative procedure for solving the system of equations, a procedure which also leads to the algorithm of choice.

Consider an iterative process starting with equal weights for all units. The values $W_i^{(0)} = 1$ can be thought of as zeroth order approximations to the weights. The first order weights are then

$$W_i^{(1)} = \frac{\sum_{k=1}^n C_{ki}}{S_i}$$

This ratio (total cites to a unit divided by the target size of the unit) is the simplest size-corrected citation measure and, in fact, corresponds to the impact measure used by Garfield. These values are then substituted into the right hand side of Equation 1 to obtain the next order of approximation. In general, the mth order approximation is

$$W_i^{(m)} = \sum_{k=1}^n \frac{W_k^{(m-1)} C_{ki}}{S_i} = \sum_{k=1}^n W_k^{(m-1)} \times \gamma_{ki} = \sum_{j=1}^n \left(\gamma^m \right)_{ji}$$

The exact weights are therefore

$$W_i = W_i^{(\infty)} = \sum_{j=1}^n \left(\lim_{m \rightarrow \infty} \gamma^m \right)_{ji}$$

This provides the most convenient numerical procedure for finding the weights, the whole iteration procedure being reduced to successive squarings of the γ matrix.

This procedure is closely related to the standard method for finding the dominant eigenvalue of a matrix. Since $\lambda = 1$ is the largest eigenvalue, repeated squarings are all that is needed. If the largest eigenvalue had a value other than 1, the normalization condition, Equation 6, would have to be reimposed with each squaring. Convergence to three decimal places usually occurs with six squarings, corresponding to raising γ to the 64th power.

C. The Classification Scheme

1. Overview of the Classification Problem

The major fields into which science and technology were divided in the first level of the classification scheme are:

- Clinical Medicine
- Biomedical Research
- Biology
- Chemistry
- Physics
- Earth and Space Science
- Engineering & Technology
- Psychology
- Mathematics

The subfields into which these major fields were divided are listed in Table 7-1. The complete list of journals with their subfield assignments is contained in the Appendix.

TABLE 7-1

LIST OF SUBFIELDS

CLINICAL MEDICINE

GENERAL AND INTERNAL MEDICINE
ALLERGY
ANESTHESIOLOGY
CANCER
CARDIOVASCULAR SYSTEM
DENTISTRY
DERMATOLOGY & VENEREAL DISEASES
ENDOCRINOLOGY
FERTILITY
GASTROENTEROLOGY
GERIATRICS
HEMATOLOGY
IMMUNOLOGY
OBSTETRICS & GYNECOLOGY
NEUROLOGY & NEUROSURGERY
OPHTHALMOLOGY
ORTHOPEDECS
ARTHRITIS & RHEUMATISM
OTORHINOLARYNGOLOGY
PATHOLOGY
PEDIATRICS
PHARMACOLOGY
PHARMACY
PSYCHIATRY
RADIOLOGY & NUCLEAR MEDICINE
RESPIRATORY SYSTEM
SURGERY
TROPICAL MEDICINE
UROLOGY
NEPHROLOGY
VETERINARY MEDICINE
ADDICTIVE DISEASES
HYGIENE & PUBLIC HEALTH
MISCELLANEOUS CLINICAL MEDICINE

BIOMEDICAL RESEARCH

PHYSIOLOGY
ANATOMY & MORPHOLOGY
EMBRYOLOGY
GENETICS & HEREDITY
NUTRITION & DIETETICS
BIOCHEMISTRY & MOLECULAR BIOLOGY
BIOPHYSICS
CELL BIOLOGY CYTOLOGY & HISTOLOGY
MICROBIOLOGY
VIROLOGY

TABLE 7-1 (Continued)

LIST OF SUBFIELDS

BIOMEDICAL RESEARCH (CONTINUED)

PARASITOLOGY
BIOMEDICAL ENGINEERING
MICROSCOPY
MISCELLANEOUS BIOMEDICAL RESEARCH
GENERAL BIOMEDICAL RESEARCH

BIOLOGY

GENERAL BIOLOGY
GENERAL ZOOLOGY
ENTOMOLOGY
MISCELLANEOUS ZOOLOGY
MARINE BIOLOGY & HYDROBIOLOGY
BOTANY
ECOLOGY
AGRICULTURE & FOOD SCIENCE
DAIRY & ANIMAL SCIENCE
MISCELLANEOUS BIOLOGY

CHEMISTRY

ANALYTICAL CHEMISTRY
ORGANIC CHEMISTRY
INORGANIC & NUCLEAR CHEMISTRY
APPLIED CHEMISTRY
GENERAL CHEMISTRY
POLYMERS
PHYSICAL CHEMISTRY

PHYSICS

CHEMICAL PHYSICS
SOLID STATE PHYSICS
FLUIDS & PLASMAS
APPLIED PHYSICS
ACOUSTICS
OPTICS
GENERAL PHYSICS
NUCLEAR & PARTICLE PHYSICS
MISCELLANEOUS PHYSICS

EARTH AND SPACE SCIENCE

ASTRONOMY & ASTROPHYSICS
METEOROLOGY & ATMOSPHERIC SCIENCE
GEOLOGY
EARTH & PLANETARY SCIENCE
GEOGRAPHY
OCEANOGRAPHY & LIMNOLOGY

TABLE 7-1 (Continued)

LIST OF SUBFIELDS

ENGINEERING AND TECHNOLOGY

- CHEMICAL ENGINEERING
- MECHANICAL ENGINEERING
- CIVIL ENGINEERING
- ELECTRICAL ENGINEERING & ELECTRONICS
- MISCELLANEOUS ENGINEERING & TECHNOLOGY
- INDUSTRIAL ENGINEERING
- GENERAL ENGINEERING
- METALS & METALLURGY
- MATERIALS SCIENCE
- NUCLEAR TECHNOLOGY
- AEROSPACE TECHNOLOGY
- COMPUTERS
- LIBRARY & INFORMATION SCIENCE
- OPERATIONS RESEARCH & MANAGEMENT SCIENCE

PSYCHOLOGY

- CLINICAL PSYCHOLOGY
- PERSONALITY & SOCIAL PSYCHOLOGY
- DEVELOPMENTAL & CHILD PSYCHOLOGY
- EXPERIMENTAL PSYCHOLOGY
- GENERAL PSYCHOLOGY
- MISCELLANEOUS PSYCHOLOGY
- BEHAVIORAL SCIENCE

MATHEMATICS

- PROBABILITY & STATISTICS
- APPLIED MATHEMATICS
- GENERAL MATHEMATICS
- MISCELLANEOUS MATHEMATICS

While, in a sense, this tabulation is self-explanatory, much effort was expended in its preparation and there are subtleties involved which should be thoroughly discussed. There is here, as in any taxonomic procedure, some degree of arbitrariness in the precise choice of fields and of the location of boundaries between fields. Pairs of fields frequently have regions of contiguity.

Field boundaries evolve with time; an area which was once a region of overlap between two established fields can develop into an independent field with its own relatively self-contained literature. An obvious example of this is the study of the chemistry of organisms, namely biochemistry. The first biochemistry journal, founded in 1877, was Hoppe-Seyler's Zeitschrift fur Physiologische Chemie. For many years it was a long interdisciplinary journal linking chemistry and biology. Since the beginning of this century the literature of biochemistry has grown to the point where it is self-contained; universities have separate biochemistry departments, at least at the graduate level.

Interactions between physics and chemistry have followed a different course. Physical chemistry is a relatively static subfield which has remained within chemistry. There is, however, a newer subfield, chemical physics which continues to straddle the border between chemistry and physics. The large Journal of Chemical Physics (JCP) is a true borderline journal linking the chemistry and physics literatures. The central chemistry and physics journals exhibit little cross citing. The only significant flow of influence is that which is "filtered" through borderline journals, particularly the JCP. This is demonstrated by the 3 x 3 matrix in Table 7-2, where the Physical Review (PR) and the Journal of The American Chemical Society (JACS) directly cite each other very little, yet each cites and is cited by JCP substantially.

TABLE 7-2

CROSS CITING BETWEEN 3 KEY JOURNALS

References from	Cites to		
	JACS	JCP	PR
JACS	15941	3085	123
JCP	899	10866	2397
PR	66	1838	25380

Although the direct physics-chemistry linking is too weak to establish a strong hierarchical relationship, the inclusion of chemical physics provides a strong connection with both chemistry and physics, establishing the hierarchical relationship:

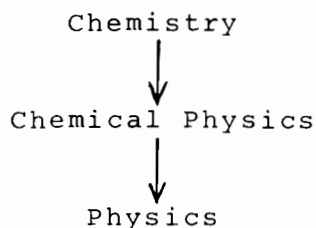

The linking role of the JCP is clearly stated on the inside cover of the journal: the editor's statement concerning the purpose of the journal is worth quoting "...to bridge a gap between journals of physics and journals of chemistry... The artificial boundary between physics and chemistry has now been in actual fact completely eliminated and... research which is as much the one as the other".

The subject of border areas will be treated after a discussion of the major fields.

2. Major Fields

The choice of major fields was influenced by several factors. The standard disciplines-mathematics, physics, chemistry and biology are represented by separate headings. Each naturally contains several subfields, some of which are self-contained. For example, optics and acoustics, which have been classified under physics, exhibit 45% and 59% self-citing respectively. Although optics and acoustics are not within the mainstream of physics, they do not approach the size needed for major field status.

The subfields which have been aggregated under earth and space sciences have been placed together due to the following considerations. The fields of astronomy, astrophysics, planetary and space science, and geophysics are interwoven by overlapping journals. Geology, geography and oceanography-limnology are also included under earth science. While astrophysics could be classed as a subfield of physics, consideration of the structure of the journal literature leads to the above grouping as the more natural one.

The life sciences present a more complex classification problem. A single category, biology, including all the life sciences is too broad. Instead of a single category, a division was made between biomedicine and the remainder of the life sciences; this remainder was grouped under biology. The aim was to separate those areas which are primarily of interest to the zoologist, botanist or applied biologist from those of more

immediate interest to the medical researcher or practitioner. In addition to zoology and botany, the biology grouping includes marine biology, ecology and areas which may be considered as applied biology, namely agriculture and food science and dairy and animal science.

The classification of journals within biomedicine requires detailed explanation. The categorization of biomedical journals is done on the basis of both subject/specialty areas and "research levels."

3. Biomedical Classification

a. Classification into Subject/Specialty Areas

The basic research areas are listed under biomedical research in Table 7-1. A level of aggregation was chosen which would render the classification as useful as possible for the subsequent analysis. Cell biology, cytology and histology were grouped together since their journal literature is sufficiently bound together as to be inseparable. Similarly, the molecular biology literature is sufficiently interwoven with biochemistry so that they are aggregated. Although biophysics has been listed as a separate subfield, many of the biochemistry journals are actually joint biochemistry-biophysics journals so that, for analysis at the subfield level, biophysics was combined with the biochemistry-molecular biology grouping.

There are numerous well defined medical specialties, each having its own journal literature. These are listed in Table 7-1 under clinical medicine. The classification of the medical literature follows the actual occurrence of the medical specialties around which the literature has arisen.

The breakdown of journals into specialty areas occurs along different directions of approach. An enumeration of the ways in which journal subfields are generated is as follows:

1. Study or treatment of a disease
e.g., cancer, arthritis
2. Practice of a technique or set
of related techniques
e.g., surgery, anesthesiology,
radiology
3. Organ or set of organs studied
e.g., ophthalmology, dermatology,
otorhinolaryngology
4. Study of a functionally related
system of organs
e.g., cardiovascular system,
digestive system

5. Age range of patient studied
e.g., pediatrics, geriatrics
6. Geographical occurrence of a set
of diseases
e.g., tropical medicine

The majority of journals lie within a particular subfield defined in one of these ways.

One subfield has been defined as general and internal medicine. It is multidisciplinary with respect to the set of medical specialties. A journal in this category contains an unspecified mixture of articles drawn from many specialties. The literature of internal medicine is sufficiently interwoven with that of general medicine that they were considered together.

The assignment of a journal to a subject category is frequently clearly indicated by its title and/or publishing organization. The citation pattern of a journal serves as a confirmation of the subject classification. Occasionally the specific focus of a journal is concealed by a more general title. This is the case with the Journal of Experimental Medicine which is actually the central immunology journal, as is evident from its citation pattern and that of the other immunology journals.

There are many journals which do not fit into a unique category. Two types of non-uniqueness may be distinguished. The first type is illustrated by Eye, Ear, Nose and Throat Monthly which accepts papers in either ophthalmology or otorhinolaryngology. Such a journal does not represent a subfield but is really "bi-disciplinary" with respect to two fields which are two parallel slices of the medical pie. One could give such a journal a split field assignment according to the average representation of each field in the journal, as inferred from its referencing pattern. Such an assignment would, however, be of limited usefulness since citations involving this type of journal cannot, without examination of the articles involved, be used to infer connections between fields. Such journals must be eliminated from the analysis of the flow of influence between fields.

The more frequent non-uniqueness situation arises from journals which constitute the "intersection" of two non-parallel categories. This type of journal, for example, the Journal of Pediatric Surgery, does represent a subfield. Splitting a subfield journal cannot be given the same interpretation as splitting a bi-disciplinary journal.

In the latter case, examination of the relative numbers of citations to each field gives an indication of the percentage of papers from each field, while in the former it indicates the extent to which the subfield draws upon each of its generating

fields. Thus, if the Journal of Pediatric Surgery refers three times as often to surgery as to pediatrics, this does not imply that on the average there are 75% surgery papers and 25% pediatrics papers, but only that the journal draws more heavily on the surgery literature, in the ratio three to one.

For a medical subfield the distinction is usually clear between the primary field or field of initial specialization and the field which represents further specialization. A pediatric surgeon is a surgeon first, who then specializes in the treatment of young patients, so that pediatric surgery is a subfield of surgery.

Several areas were placed in "miscellaneous subfields" because they were considered too small to be given their own groupings. These include occupational medicine, aerospace medicine, forensic medicine, medical education, and biological photography and illustration.

b. Classification into Research Levels

In the process of subject classification of the biomedical journals a feature of their citation patterns was observed which motivated the introduction of another dimension into the classification of the literature. This classification is based on a spectrum of research orientation ranging from basic research to clinical practice. Four levels in this spectrum were sufficiently discernable to base a second dimension on the concept of research level. These levels are:

- Level 1 - Clinical Observation
- Level 2 - Clinical Mix
- Level 3 - Clinical Investigation
- Level 4 - Fundamental Research

The four levels characterizing the research orientation of biomedically related journals are well illustrated by four leading journals. The Journal of Biological Chemistry (JBC, Level 4) is a central journal in fundamental biomedical research. It cites overwhelmingly within its own area of fundamental research. The Journal of the American Medical Association, (JAMA, Level 1), New England Journal of Medicine (NEJM, Level 2), and the Journal of Clinical Investigation (JCI, Level 3) illustrates the three levels of medical journals. The JCI is highly research oriented, the word investigation being more descriptively appropriate than the word clinical. The JAMA at the other end of the research orientation spectrum may be described as a journal of clinical observation. The NEJM, containing a more even mix of observation and investigation, is intermediate between the JAMA and the JCI.

An examination of the referencing pattern of these four prototype journals will explain the rationale for the separation of the literature into four research levels.

The extent of citing from a fundamental research journal such as the JBC back to the medical literature is minimal. In a rank ordering of journals cited by JBC, based on 1973 data, the JCI ranks 22nd, NEJM, 78th, and the JAMA is not in the first hundred. The order of citing from the JAMA is just the reverse. It cites the NEJM second, JCI, 12th, and the JBC, 66th. Table 7-3 summarizes the citing order among the four journals. Here each of the four refers to itself (main diagonal) most frequently; the extent of citing falls off sharply with distance from the main diagonal. Level 4 (fundamental research) journals cite their own level to a high degree while medical journals cite within their own level and the levels immediately above and below their level. This includes a high level of citation from Level 3 (clinical investigation) to the fundamental research level. The detailed referencing list for the four journals is given in Table 7-4.

The differences in the citing pattern of these four journals suggest a definite pattern which may be used to classify other medical journals. The medical fields themselves are not placed in either a clinical or research category; it is only the individual journals which are so categorized. The journals in a particular field may tend toward one or the other end of the research spectrum. The immunology, pathology, and endocrinology journals are almost entirely on the clinical investigation level while most of the surgery journals are on the clinical observation level. In other fields there was a wider range of research orientations. The journals dealing with the cardiovascular system are distributed over all research levels. Some journals classed as fundamental research were, for their subject classification, included with the related medical fields; e.g., Microvascular Research with the cardiovascular system, Brain Research with neurology and Respiration Physiology with respiratory system. Respiration Physiology cites as a physiology journal, but because of its specific focus it was classed as a respiratory journal. Following that line of reasoning, general physiology could be thought of as a Level 4 of general medicine although we have not classified it as such.

The actual separation of biomedical journals into the major fields of clinical medicine and biomedical research is not made on the basis of subject/specialty classification but on the basis of research level. Levels 1 and 2 are considered to be clinical medicine; Levels 3 and 4 are classified as biomedical research.

4. Linking Areas

The existence of border or linking areas between pairs of fields introduces an arbitrary element into the classification procedure. Such linking areas can frequently be considered to belong equally well to one or the other of the overlapping fields, or to remain unattached, suspended between them.

TABLE 7-3*

REFERENCING RANK ORDER AMONG PROTOTYPE JOURNALS IN 1973

	To JAMA	To NEJM	To JCI	To JBC
From JAMA	1	2	12	66
From NEJM	4	1	3	22
From JCI	63	4	1	3
From JBC	> 100	78	22	1

*JAMA - Journal of the American Medical Association
 NEJM - New England Journal of Medicine
 JCI - Journal of Clinical Investigation
 JBC - Journal of Biological Chemistry

TABLE 7-4

REFERENCING FROM PROTOTYPE JOURNALS IN 1973

FROM:		FROM:		FROM:		FROM:	
J AM MED A		N ENG J MED		J CLIN INV		J BIOL CHEM	
TO:		TO:		TO:		TO:	
1 J AM MED A	841	N ENG J MED	1453	J CLIN INV	1348	J BIOL CHEM	8797
2 N ENG J MED	497	LANCET	604	AM J PHYSL	524	BIOC BIOP A	2287
3 LANCET	308	J CLIN INV	391	J BIOL CHEM	504	BIOCHEM	2094
4 ANN INT MED	239	J AM MED A	336	N ENG J MED	278	P NAS US	1877
5 BR MED J	188	CIRCULATION	252	J CLIN END	276	BIOC BIOP R	1506
6 AM J MED	140	SCIENCE	246	NATURE	269	BIOCHEM J	1281
7 CIRCULATION	138	AM J MED	230	J EXP MED	254	NATURE	1125
8 ARCH IN MED	109	ANN INT MED	212	SCIENCE	219	ARCH BIOCH	917
9 CANCER	99	BR MED J	201	J LA CL MED	215	J MOL BIOL	833
10 AM J CARD	98	NATURE	177	J IMMUNOL	201	EUR J BIOCH	731
11 ARTH RHEUM	76	GASTROENTY	171	BIOC BIOP A	200	J AM CHEM S	651
12 J CLIN INV	71	PEDIATRICS	162	LANCET	200	FED PROC	611
13 J BONE JOIN	70	J EXP MED	143	P NAS US	179	SCIENCE	564
14 SCIENCE	68	J CLIN END	141	ENDOCRINOL	177	ANALYT BIOC	484
15 AM J OBST G	67	P NAS US	138	J APP PHYSL	172	J BACT	381
16 AM HEART J	61	J LA CL MED	131	P SOC EXP M	171	FEBS LETTER	370
17 ANN RHEUM D	57	CANCER	129	AM J MED	153	J CELL BIOL	281
18 J PEDIAT	57	J PEDIAT	128	BLOOD	146	ANN NY ACAD	269
19 RADIOLOGY	57	ANN SURG	127	GASTROENTY	131	ANALYT CHEM	264
20 J UROL	56	BLOOD	121	CLIN RES	128	J LIPID RES	251
21 ARCH SURG	55	J PED SURG	116	BIOCHEM J	126	J BIOCHEM	249
22 AM J DIS CH	53	J BIOL CHEM	113	J LIPID RES	124	J CLIN INV	220
23 J INFEC DIS	50	J IMMUNOL	112	CIRCUL RES	106	COLD S HARB	220
24 ANN SURG	49	ARCH IN MED	104	DIABETES	105	ENDOCRINOL	216
25 MEDICINE	48	AM J DIS CH	104	FED PROC	102	ANN R BIOCH	201
26 AM J ROENTG	47	AM J CARD	103	ANN INT MED	94	H-S Z PHYSL	145
27 ARCH DERMAT	46	AM HEART J	98	CIRCULATION	88	AM J PHYSL	137
28 J THOR SURG	46	P SOC EXP M	96	BIOCHEM	87	ACT CHEM SC	124
29 SURG GYN OB	45	ARCH SURG	88	BIOC BIOP A	81	MOLEC PHARM	121
30 GASTROENTY	44	SURGERY	82	J PHYSL LON	81	J GEN PHYSL	107
31 CHEST	41	J PHARM EXP	76	J PHARM EXP	63	J CHEM S	105
32 ANESTHESIOL	40	ARCH DERMAT	74	PFLUG ARCH	62	CANCER RES	103
33 SURGERY	39	CANCER RES	72	METABOLISM	62	ADV PROTEIN	102
34 AM J CLIN P	38	AM J SURG	72	BR J HAEM	62	EXP CELL RE	99
35 CAN MED A J	38	AM J PHYSL	71	BR MED J	59	VIROLOGY	98
36 PEDIATRICS	37	SURG GYN OB	70	ARTH RHEUM	55	J NEUROCHEM	95
37 CANCER RES	37	J THOR SURG	68	ANALYT BIOC	53	J CHEM PHYS	92
38 BLOOD	37	J INFEC DIS	66	ANN NY ACAD	52	P SOC EXP M	92
39 ANN NY ACAD	35	NEUROLOGY	65	ACT PHYSL S	48	ADV ENZYM	90
40 NEUROLOGY	35	CLIN RES	63	CLIN SCI	48	CAN J BIOCH	86
41 J LA CL MED	33	GUT	61	J CELL BIOL	47	J EXP MED	78
42 AM J MED SC	33	ANN NY ACAD	61	CANCER RES	47	J PHYS CHEM	77
43 BR HEART J	32	AM J EPIDEM	61	CLIN EXP IM	46	P ROY SOC	76
44 J CLIN END	32	ARCH NEUROL	59	J GEN PHYSL	46	J LA CL MED	61
45 J EXP MED	32	AM J OBST G	59	SC J CL INV	45	BIOCHIMIE	59
46 NATURE	32	AM J MED SC	59	THROMB DIAT	44	BIOCH PHARM	59
47 J NEUROSURG	30	ARCH DIS CH	58	INT A ALLER	44	ADV ENZ REG	56
48 ARCH NEUROL	30	CIRCUL RES	57	CLIN CHIM A	44	DIABETES	56
49 AM R RESP D	30	ENDOCRINOL	55	ARCH BIOCH	42	BIOPOLYMERS	55
50 AM J PSYCHI	29	MEDICINE	55	IMMUNOLOGY	40	J CHROMAT	54
51 CLIN ORTHOP	28	RADIOLOGY	54	PHYSIOL REV	39	J PHYSL LON	53
TOTAL:	6301		11544	12	9854		32057

This decision affects the influence weights since a large proportion of the citing between fields generally occurs through the linking areas. The linking nature of chemical physics has already been discussed. Additional linking subfields and overlapping areas will now be enumerated.

Behavioral science links psychology and biology but has been included in psychology. Psychology also has an interface with psychiatry which is within clinical medicine. Journals dealing with psychotherapy and medical psychology are on the border between the two fields.

Marine biology/hydrobiology are subfields of biology while oceanography/limnology are classified under earth and space science. Oceanography/limnology journals publish many biological articles so that there is considerable overlap in subject matter.

The subject area of mechanics extends across mathematics and physics to engineering. The esoteric Journal of Rational Mechanics and Analysis is highly mathematical and was classified under applied mathematics. The Journal of Applied Mechanics, published by the American Society of Mechanical Engineers is classified under mechanical engineering. The Journal of Fluid Mechanics appears in the Fluids and Plasmas category under physics.

In the analysis of the flow of information within a field, the influence weights are meaningful only for subfields which are distinct or self contained with respect to the journal literature. As mentioned previously, this is the case for optics and acoustics. Journals classified within these subfields are the primary vehicle for communication in their respective subfields. One can then investigate the flow of information between optics or acoustics and some other area of research.

The subfield nuclear physics, on the other hand, does not have its own self contained journal literature. There are few journals limited to nuclear physics. The journal Nuclear Physics is divided into A and B sections, one of which is devoted to nuclear structure, the other to elementary particles and fields. The Physical Review is divided into four sections. Section C covers nuclear structure, D covers particles and fields, B covers solid state while A includes the remainder of physics research. This split into sections has occurred within the last six years. Not only are references to an earlier period inseparable by subfield but more recent referencing has also been careless, frequently neglecting to specify section. One is then forced to recombine the sections, losing all subfield citation information. Physical Review is thus considered as a single journal and must be classified as "general physics". The two sections of Nuclear Physics are also combined so that it covers both nuclear and particle physics.

Care must be taken to avoid confusing a journal category with a research area in the case of "general" journals. "General physics" is not an area of research but a category for journals which contain an unspecified mixture of publications cutting across subfield boundaries. The bulk of publications in nuclear physics appears not in specialized journals but in journals which are either manifestly non-specific in orientation or which do have a specific section which cannot, however, be isolated for citation analysis due to current citation practices.

5. Multidisciplinary Journals

Similar remarks hold for multidisciplinary journals. Such journals are general not just at the subfield level but with respect to major field categories as well. Even if a journal is heavily oriented toward one area, the fact that it does accept publications in other areas necessitates that it be considered a multidisciplinary journal. For instance, a large proportion of the publications in the Proceedings of the National Academy of Sciences (U.S.), (P NAS US) involve biomedical research. However, there are also chemistry and occasional physics and mathematics publications. It must therefore be treated as a multidisciplinary journal in any cross field citation analysis. If it were treated as a biomedical journal, a reference from a physics journal to a (rare) physics paper in P NAS US would count as a citation from physics to biomedical research, introducing spurious cross field citing. The journal Science, although heavily biomedical and biological has a substantial proportion of publications in the earth sciences. Each multidisciplinary journal has its own characteristic mix of subject matter which may, of course, vary with time. For the purpose of obtaining publication counts in each field, the proportion of a multidisciplinary journal devoted to each field may be estimated. Such a journal cannot, however, be included in the calculation of cross field influence weights without separate examination of citations and references to and from each publication.

There is also, for some journals, the problem of identifying sections devoted to particular fields or groups of fields. For example, Proceedings of the Royal Society, London (P ROY SOC) and Comptes Rendus (CR AC SCI) are published in sections but must be recombined due to non-specificity in citation. Similarly, Nature, which recently initiated sections called Nature-New Biology and Nature-Physical Science while continuing to publish a general Nature, must be recombined and treated as a single multi-disciplinary journal.

D. Hierarchies of Journals

Previous techniques generated hierarchies of referencing units by the examination of pairs of units. If unit A referenced unit B more than it was cited by B, unit A was placed above B in the hierarchy. However, for a hierarchy based on pairwise

comparisons, there is no guarantee of a unique ordering, that is, the system will not in general be transitive, although usually it is.

The influence weighting scheme provides a natural basis for the construction of a hierarchy by:

- 1) Yielding a unique ordering for the units (based on any given measure such as influence weight, influence per publication, or total influence)
- 2) Taking into account the relative significance of the set of pairwise relations
- 3) Dictating the spacing between units, that is, providing a cardinal rather than merely an ordinal scale.

It is interesting to examine the 3 x 3 citation matrix in Table 7-5 for the journals Nature, Science and P NAS US and the hierarchies which are implied.

TABLE 7-5

CROSS CITING BETWEEN 3 MULTIDISCIPLINARY JOURNALS

References from \ Cites to	NATURE	SCIENCE	P NAS US
NATURE	4305	1218	1612
SCIENCE	785	1626	573
P NAS US	1397	543	2183

The pairwise hierarchy is:

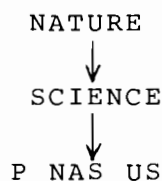

since P NAS US is cited more by both Nature and Science than it refers to them, and Science is cited by Nature more than it refers to Nature.

The influence measures for the system consisting of these three journals are given in Table 7-6. These measures apply only to influence flow within this trio of journals and bear no relation to the weights of these journals within biomedicine or within all of science.

TABLE 7-6

INFLUENCE MEASURES FOR 3 MULTIDISCIPLINARY JOURNALS

JNL NAME	INFL WT	REFS/PUB	INFL/PUB	PUBS.	TOT INFL
NATURE	0.868	11.55	10.02	2397	24021
P NAS US	1.078	18.62	20.07	789	15835
SCIENCE	1.209	13.93	16.84	1016	17108

The influence weights yield a different hierarchy:

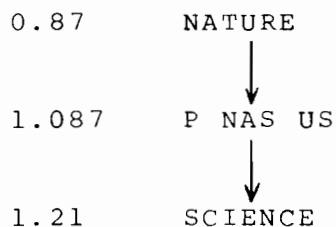

The reason for the reversal in order between P NAS US and Science is evident from an examination of the citation matrix. Although the balance of citations between P NAS US and Science is in favor of P NAS US 573 to 543, the difference is small. On the other hand, comparison of the balance between P NAS US and Nature (1612 to 1397) with the balance between Science and Nature (1218 to 785) indicates a much larger difference in the latter case. This overrides the effect of the P NAS US-Science balance, placing Science at the base of the hierarchy.

It is apparent that the weighting procedure takes relative magnitudes into consideration rather than just the sign of the inequality of the citing pairs.

Further variations in ranking arise from the other measures shown in Table 7-6. The hierarchy based upon influence per publication is:

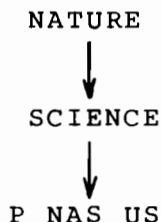

while the hierarchy based on total journal influence is

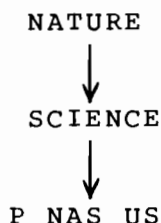

Since each hierarchy reflects different information about interactions of the units involved, there is no conflict or ambiguity in the methodology. In general, the influence weight hierarchy will be the one closely related to a "pecking order" or prestige ranking. However, a funding or evaluation agency may be more interested in a ranking based upon influence per publication.

E. Application to Physics Journals

Appendix I lists the influence measures for all of the fields, subfields and journals covered by the Science Citation Index in 1973. This section will discuss these measures for physics journals.

The influence measures for physics journals are listed in Table 7-7. Journals in astronomy and astrophysics and in geophysics were classified in the field of earth and space science rather than in physics and, therefore, are not included in this section. Multidisciplinary journals such as Science, Nature and the Proceedings of the Royal Society (London) also do not appear.

Journal relationships within the set of physics journals are shown graphically in a set of influence maps. Each influence map is a representation of journal influence within a subfield or related group of subfields. The following conventions apply to these maps:

TABLE 7-7*

INFLUENCE MEASURES FOR PHYSICS JOURNALS

PHYSICS	INFL WT	REFS/ PUB	INFL/ PUB	PUBS	TOT INFL
<u>GENERAL PHYSICS</u>					
ACT PHYS AU	0.24	12.4	3.0	54	164
ACT PHYS CH	0.47	10.5	4.9	23	113
ACT PHYS H	0.33	13.4	4.4	42	184
ADV PHYSICS	1.12	125.1	140.4	11	1545
AM J PHYS	0.94	3.0	2.9	323	924
ANN PHYSICS	1.66	17.4	29.0	147	4256
ANN PHYSIK	1.95	8.8	17.2	49	842
ANN R NUCL	0.45	116.8	52.7	12	632
CAN J PHYS	0.86	13.3	11.5	339	3898
CONT PHYS	0.29	20.1	5.8	20	117
CZEC J PHYS	0.22	9.3	2.0	193	392
FORTSCHR PH	0.37	32.1	11.7	16	187
HELV PHYS A	1.15	4.4	5.1	180	918
I J PHYSICS	0.34	7.6	2.6	74	189
IVUZ FIZ	0.01	5.0	0.0	435	13
J PHYS	0.59	13.1	7.7	1672	12908
JETP LETTER	1.25	9.8	12.2	349	4268
LETT NUOV C	0.32	8.1	2.6	609	1583
NUOV CIM	1.04	13.8	14.3	449	6425
P PM S JAP	0.74	10.4	7.6	820	6257
PHILOS MAG	1.97	12.7	24.9	228	5673
PHYS LETT	1.60	7.5	12.1	1622	19578
PHYS NORVEG	0.73	12.8	9.4	12	112
PHYS REV	1.42	18.6	26.4	3648	96307
PHYS REV L	3.42	11.1	38.1	897	34185
PHYS SCR	0.17	15.8	2.8	149	411
PHYS TODAY	0.41	17.2	7.0	33	232
PHYSICA	0.85	13.0	11.1	309	3433
PROG T PHYS	0.55	17.0	9.4	396	3711
REP PR PHYS	0.27	117.6	31.6	29	917
REV M PHYS	2.10	116.9	245.8	18	4424
REV RO PHYS	0.08	8.2	0.7	113	75
SOV J NUC R	0.52	16.2	8.4	315	2637
SOV PH JE R	2.35	10.6	24.9	598	14902
Z PHYS	1.11	14.5	16.0	346	5529

*For full titles of journal titles abbreviated, please see Appendix II.

TABLE 7-7* (Continued)

INFLUENCE MEASURES FOR PHYSICS JOURNALS

PHYSICS	INFL WT	REFS/ PUBS	INFL/ PUB	PUBS	TOT INFL
<u>NUCLEAR & PARTICLE</u>					
<u>PHYSICS</u>					
NUCL PHYS	0.93	21.8	20.2	1209	24446
USP FIZ NAU	0.20	63.9	12.6	64	806
<u>SOLID STATE PHYSICS</u>					
J PHYS CH S	1.24	16.2	20.1	252	5078
PHYS ST SOL	0.31	11.9	3.7	1496	5505
SOL ST COMM	0.51	9.3	4.7	777	3675
SOV PH SE R	0.14	13.9	2.0	479	944
SOV PH SS R	0.58	8.2	4.8	905	4308
<u>CHEMICAL PHYSICS</u>					
CHEM P LETT	0.39	11.1	4.3	969	4241
J CHEM PHYS	1.36	18.2	24.8	1448	35931
J MAGN RES	0.11	14.5	1.5	190	291
MOLEC PHYS	0.35	17.8	6.2	389	1780
SURF SCI	0.37	17.1	6.4	324	2077
<u>APPLIED PHYSICS</u>					
APPL PHYS L	1.89	7.2	13.6	498	6748
CRYOGENICS	0.40	7.8	3.1	151	465
ENERGY CONV	0.45	6.8	3.1	16	49
FERROELECTR	0.20	29.1	5.7	23	131
HIGH TEMP R	0.07	7.6	0.5	263	137
HIGH TEMP S	0.25	15.8	3.9	42	163
I J PA PHYS	0.06	8.5	0.5	348	181
IEEE J Q EL	0.70	15.6	10.9	159	1730
INFRAR PHYS	0.50	6.7	3.3	35	117
J APPL PHYS	1.23	11.3	13.9	1051	14619
J L TEMP PH	0.22	18.2	4.0	174	696
J MECANIQUE	0.56	5.9	3.3	22	72
J MECH PHYS	2.95	7.6	22.5	22	496
J VAC SCI T	0.42	13.6	5.7	156	883
JAP J A PHY	0.34	7.4	2.5	433	1074

*For full titles of journal titles abbreviated, please see Appendix II.

TABLE 7-7* (Continued)

INFLUENCE MEASURES FOR PHYSICS JOURNALS

PHYSICS	INFL WT	REFS/ PUB	INFL/ PUB	PUBS	TOT INFL
<u>APPLIED PHYSICS</u>					
(Continued)					
METROLOGIA	0.80	8.9	7.2	24	172
NUCL INSTR	0.65	8.8	5.7	627	3593
PHIL RES R	0.86	17.3	14.8	37	548
PHIL TECH R	0.49	8.0	3.9	36	140
PRIB TEKHN	0.23	2.8	0.6	537	349
REP NRL PRO	0.10	1.6	0.2	241	39
REV IN HAUT	0.12	13.0	1.6	28	46
REV PHYS AP	0.19	9.8	1.8	60	110
REV SCI INS	1.72	5.5	9.5	434	4127
SOV PH TP R	0.77	6.4	4.9	367	1809
THIN SOL FI	0.15	11.8	1.8	248	436
VACUUM	0.22	8.7	2.0	77	152
VAKUUM-TECH	0.02	9.9	0.2	28	7
VIDE	0.19	4.1	0.8	43	34
<u>FLUIDS & PLASMAS</u>					
ANN R FLUID	0.26	34.1	8.8	16	140
J FLUID MEC	1.31	10.0	13.1	236	3092
J PLASMA PH	0.39	10.5	4.1	71	290
NUCL FUSION	0.56	12.2	6.8	79	536
PHYS FLUIDS	1.39	9.9	13.9	362	5014
PLASMA PHYS	0.56	8.1	4.5	124	556
<u>ACOUSTICS</u>					
ACUSTICA	0.33	6.8	2.2	110	245
IEEE AUDIO	0.22	6.6	1.4	76	109
IEEE SON UL	0.55	12.0	6.6	51	338
J ACOUST SO	1.50	10.0	15.0	350	5250
J AUD ENG S	0.17	5.6	0.9	71	66
J SOUND VIB	0.27	7.4	2.0	191	382
SOV PH AC R	0.43	7.7	3.3	108	361
ULTRASONICS	0.29	6.4	1.8	32	58

*For full titles of journal titles abbreviated, please see Appendix II.

TABLE 7-7* (Continued)

INFLUENCE MEASURES FOR PHYSICS JOURNALS

PHYSICS	INFL WT	REFS/ PUB	INFL/ PUB	PUBS	TOT INFL
<u>OPTICS</u>					
APPL OPTICS	0.82	9.5	7.8	430	3337
J OPT SOC	1.95	12.1	23.5	232	5464
J PHOT SCI	0.13	13.0	1.7	43	74
OPTICA ACTA	0.42	10.7	4.5	63	282
OPTIK	0.60	7.2	4.3	107	463
PHOT SCI EN	0.13	13.3	1.7	91	159
PHOTOGR ENG	0.49	2.1	1.0	85	88
ZH NP FOTOG	0.06	6.5	0.4	78	28
<u>MISCELLANEOUS PHYSICS</u>					
ANN I HEN A	0.99	7.6	7.6	40	303
COMM MATH P	1.41	7.5	10.5	122	1286
J COMPUT PH	0.19	8.1	1.5	128	192
J MATH PHYS	1.54	9.2	14.1	290	4092
PHYS COND M	0.60	24.2	14.5	31	450

*For full titles of journal titles abbreviated, please see Appendix II.

1. A solid rectangle is used to represent journals within the subfield or subfields being presented on a given map. SCI journal abbreviations are used for all journals. These abbreviations are defined in Appendix II. The area of a rectangle is proportional to the size of a journal, as measured by the number of articles, notes and reviews in the Corporate Index of the SCI in 1973.
2. The vertical scale shows influence per publication for each journal on a log scale. Weights for a set of units tend to be distributed in a log uniform rather than in a uniform manner and so use of a log scale results in less crowding for the lower weight units. Only journals reporting original research appear on the maps. Review journals, because of the large size of their individual publications, tend to have exceptionally high influence per publication. Their role in the literature is different from that of journals that report primarily original research; it is not, therefore, appropriate to compare the influence per publication of review and research journals.
3. The horizontal direction is used to separate either different subfields appearing on the same map, or journals with different specific foci. Journals in the same column tend to be more similar to each other than to journals in neighboring columns.
4. Arrows are directed from a journal to the other journals, exclusive of itself, to which it refers most frequently. Usually, two arrows are drawn from each journal showing the two other journals that are most frequently referenced; occasionally three are given if the number of references to the second and third are close, or there may be only one if a single arrow best characterizes the referencing priority of the journal. An arrow with a full head is used for a first arrow (largest number of references) while a half head is used for

a second or third arrow. A dotted arrow is used for a secondary arrow which is considerably weaker than the primary arrow. If an arrow is directed to a journal which is not classified as being in the field under study, the "target" journal may be treated in one of several ways:

- a) If the journal is of exceptional importance to the journals within the field of interest it will appear in a dashed rectangle located on the vertical scale by its influence per publication. An example of this is the appearance of Physical Review Letters on the map of fluids and plasmas journals.
- b) Arrows directed out of the subfield to journals which are not of central importance to the field are generally short arrows leading to the unenclosed journal name. For this case there is no significance to the vertical placement of the cited journal.

The fields of acoustics (Figure 7-1) and optics (Figure 7-2) are each dominated by their respective American Institute of Physics publications, the Journal of the Acoustical Society of America and the Journal of the Optical Society of America. The Optical Society journal has an influence per publication which is three times that of the nearest optical journal. In Figure 7-2 the photographic science journals appear to the right of the central column of optics journals while the journal Infrared Physics is at the left. In the acoustics map, the journals dealing with ultrasound are separated from the main acoustics column. It is a common phenomenon that the most influential journal in a subfield refers frequently to large, more general journals. This is seen in the references from the Acoustical Society journal to the Journal of Applied Physics and Science, and from the Optical Society journal to the Physical Review.

The map for journals in fluids and plasmas is shown in Figure 7-3. Here there are two journals, Physics of Fluids and the Journal of Fluid Mechanics which have almost equal values for the influence per publication. The journals in plasma

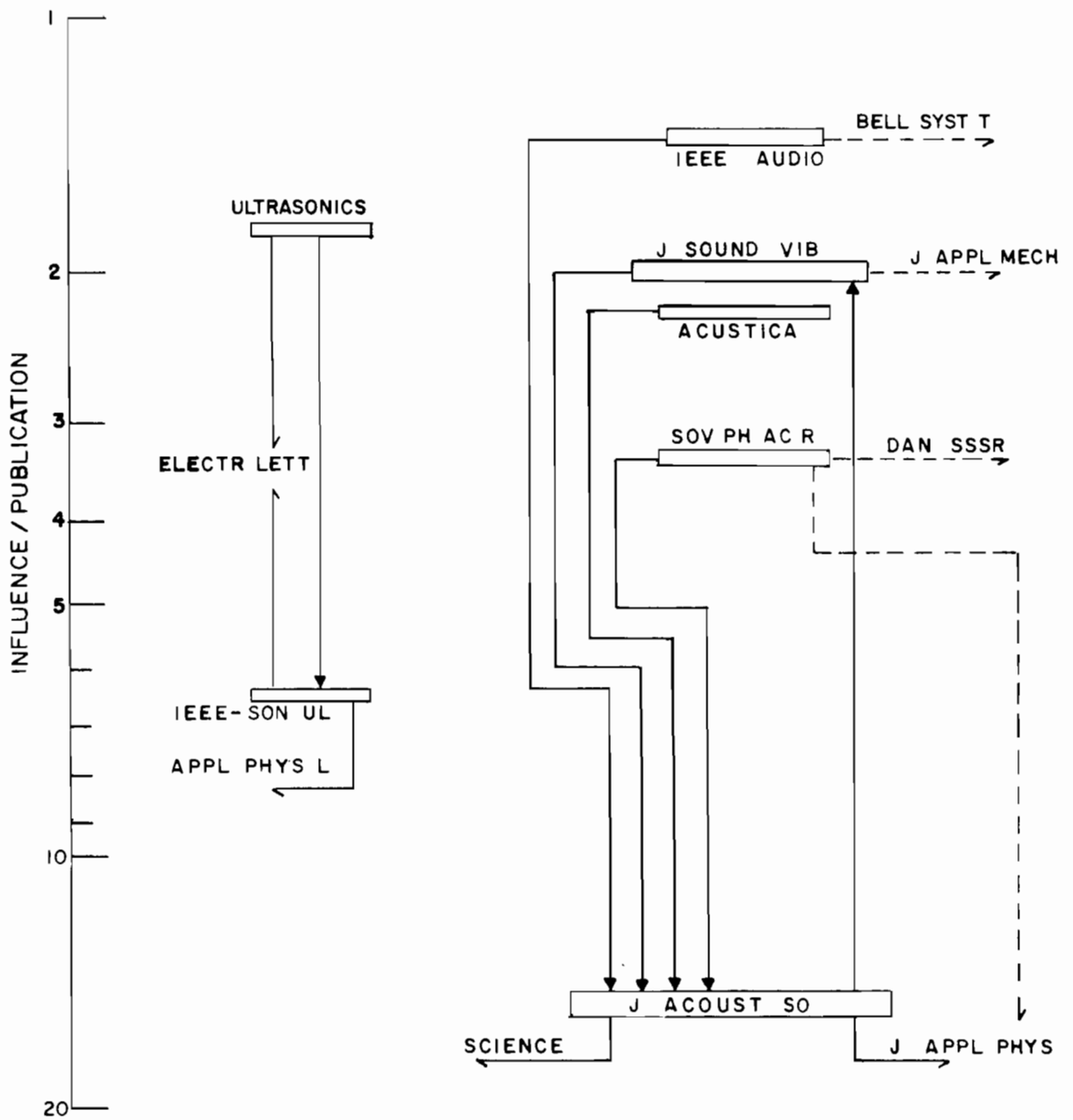

FIGURE 7-1
 INFLUENCE MAP FOR ACOUSTICS JOURNALS

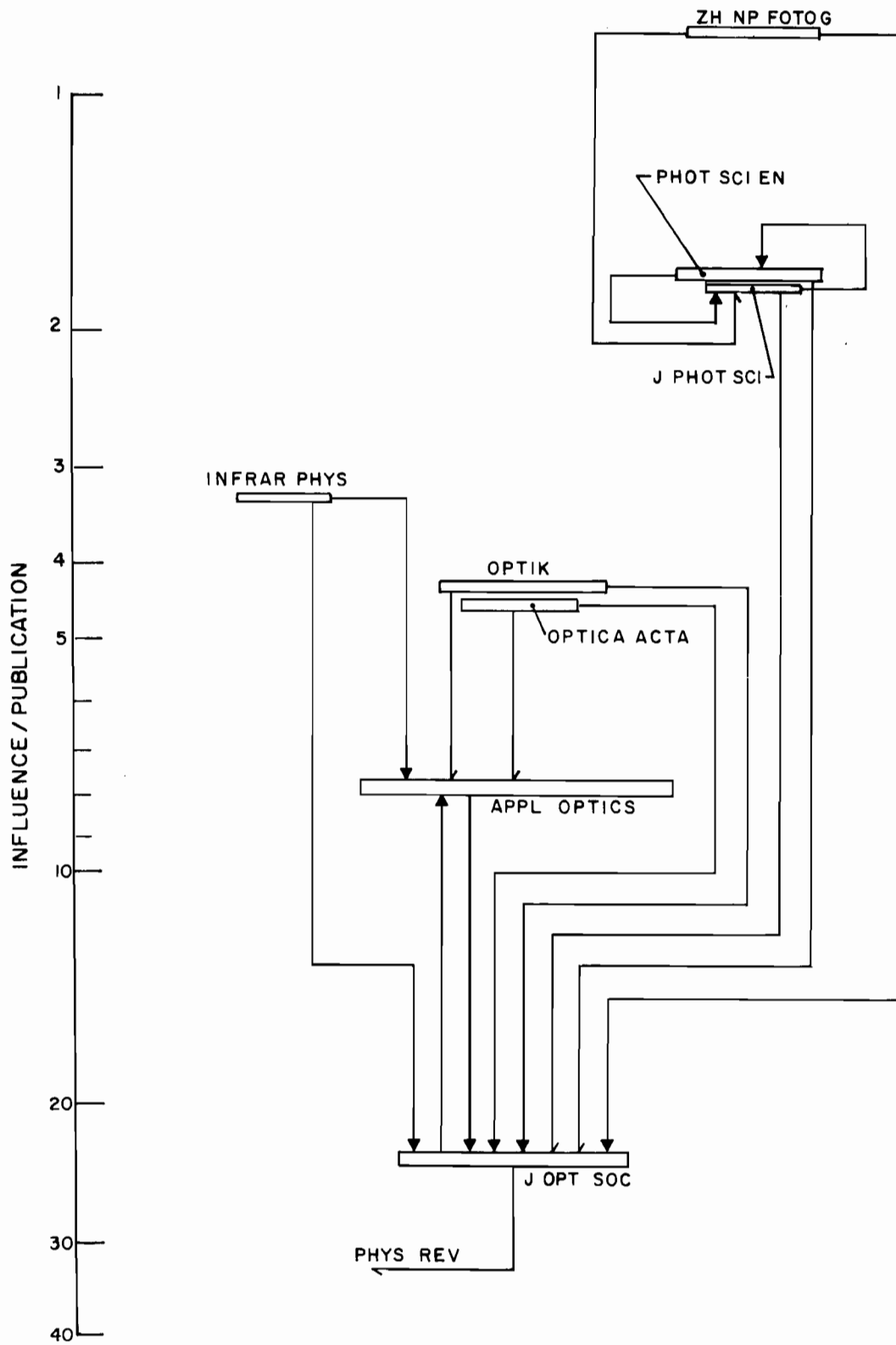

FIGURE 7-2

INFLUENCE MAP FOR OPTICS JOURNALS

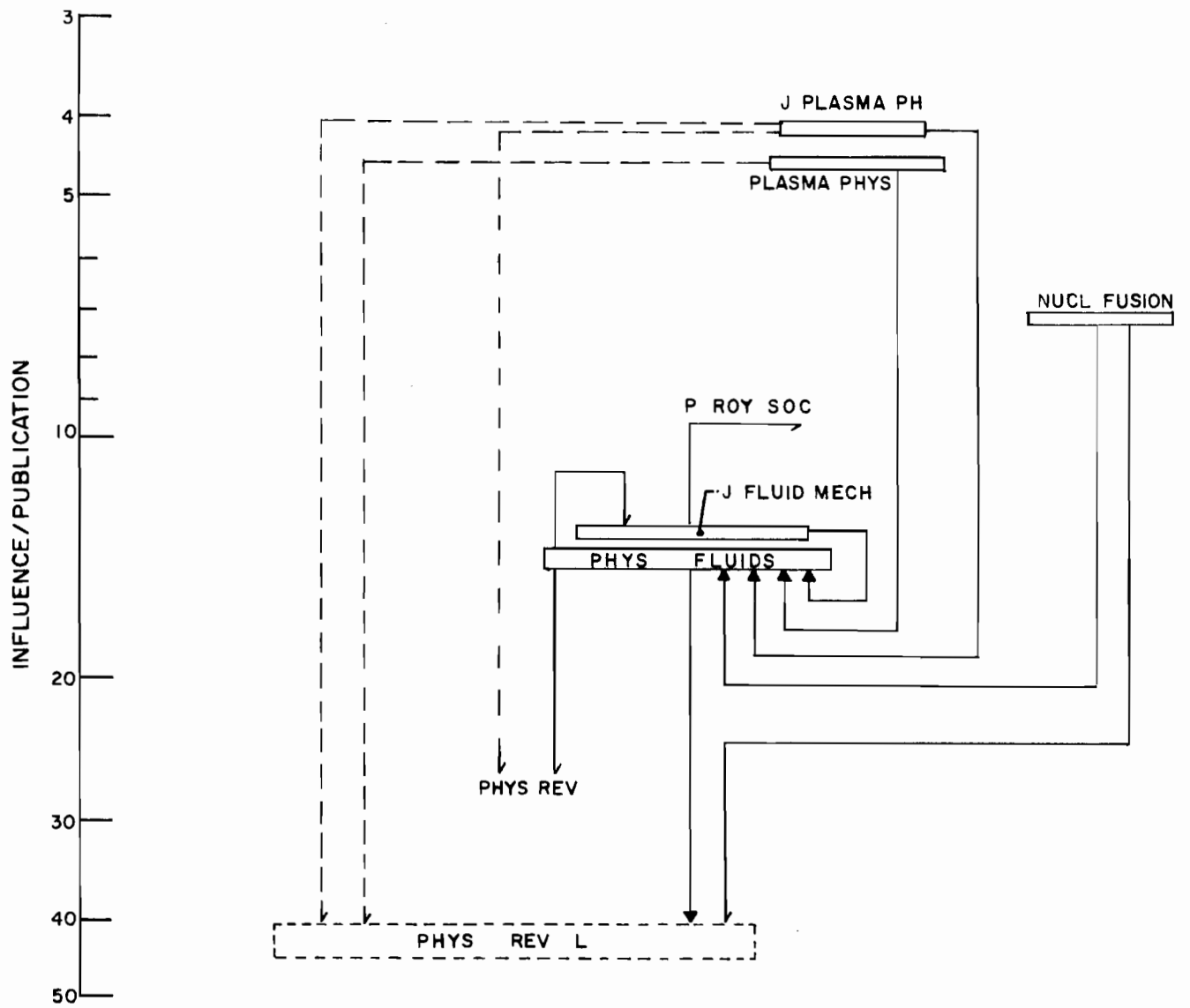

FIGURE 7-3

INFLUENCE MAP FOR FLUIDS & PLASMA JOURNALS

physics and the journal Nuclear Fusion are separated towards the right. It is apparent that much work of interest to this subfield is published in the general physics literature. Physics of Fluids refers most often to Physical Review Letters and next to the Physical Review, while most of the others in the group give their second arrow to one of the general journals.

The subfields of physics vary in the extent to which their literature is self-contained. While acoustics and optics each have a literature which is highly self-contained, solid state and nuclear physics research are dispersed throughout the general physics literature in addition to appearing in journals specific for these subfields. The citation analysis of these subfields of physics is impeded by the journal section problem. Since 1970 the Physical Review has been divided into four sections. Section C covers nuclear structure, D covers particles and fields, B covers solid state while A includes the remainder of physics research. During 1964 and 1965 there were only two sections, with B covering nuclear and elementary particle physics and A solid state and other topics. In all other years there was no sectional division. If we use citation data for all previous years then it is clear that citations to the different subfields cannot be segregated. The sections of the Physical Review were therefore recombined giving a single massive general journal. Similar problems exist for the journals Nuovo Cimento, Physics Letters, Journal of Physics and for Nuclear Physics which is now split between nuclear structure in one section and particles and fields in the other. The result is that the largest, most central physics journals are forced into the general physics category. Only two journals were classified as nuclear and particle physics journals.

Figure 7-4 contains the general physics journals together with solid state, nuclear and mathematical physics. The general journals are in the central column with the letter journals displaced slightly towards the left. The Physical Review is referred to most frequently by a large majority of journals on this map. Arrows are most closely related to total influence so that this fact is explained in large part by the size of the journal. Since Annals of Physics has a higher influence per publication, it lies below Physical Review in the hierarchy. The same is true for Physical Review Letters which has the highest influence per publication of all the physics journals.

Applied physics and chemical physics journals appear in Figure 7-5. While the Journal of Applied Physics and Applied Physics Letters are leading journals in the applied area, most applied journals refer to them less frequently than they do to the Physical Review. The Journal of Chemical Physics is cited highly by a wide range of journals including general physics journals and those in chemical, solid state and applied physics as well as general and physical chemistry journals.

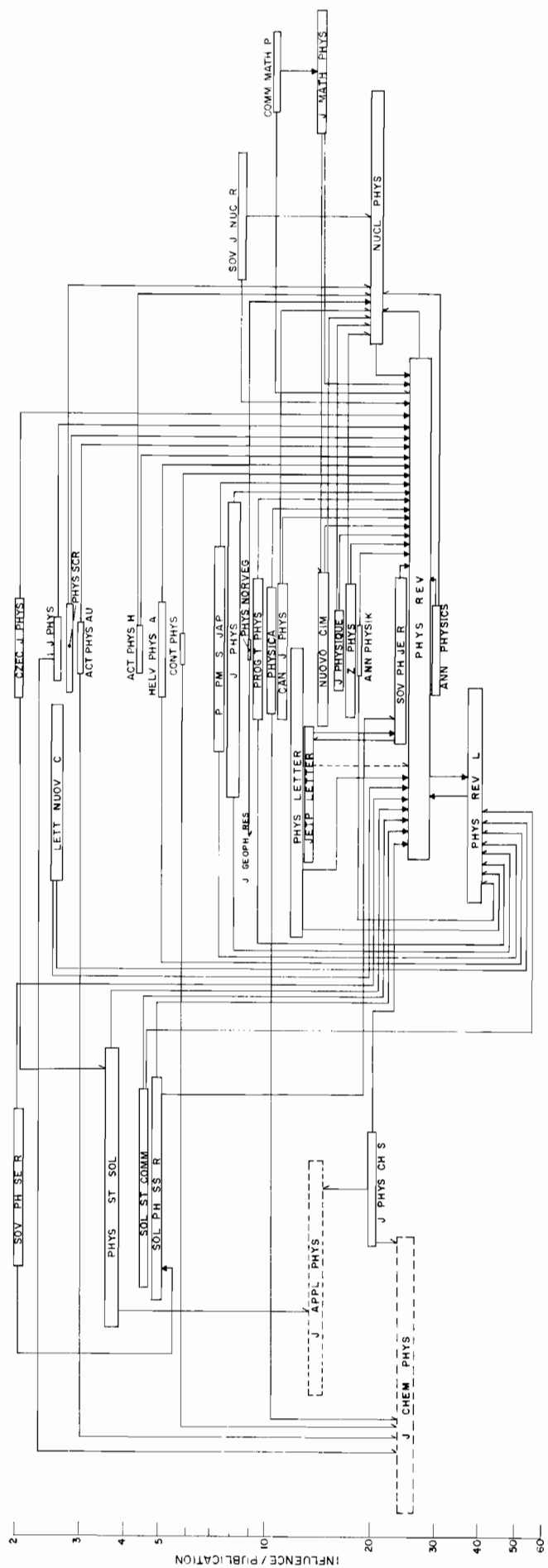

FIGURE 7-4
 INFLUENCE MAP FOR GENERAL, SOLID STATE
 AND NUCLEAR PHYSICS JOURNALS

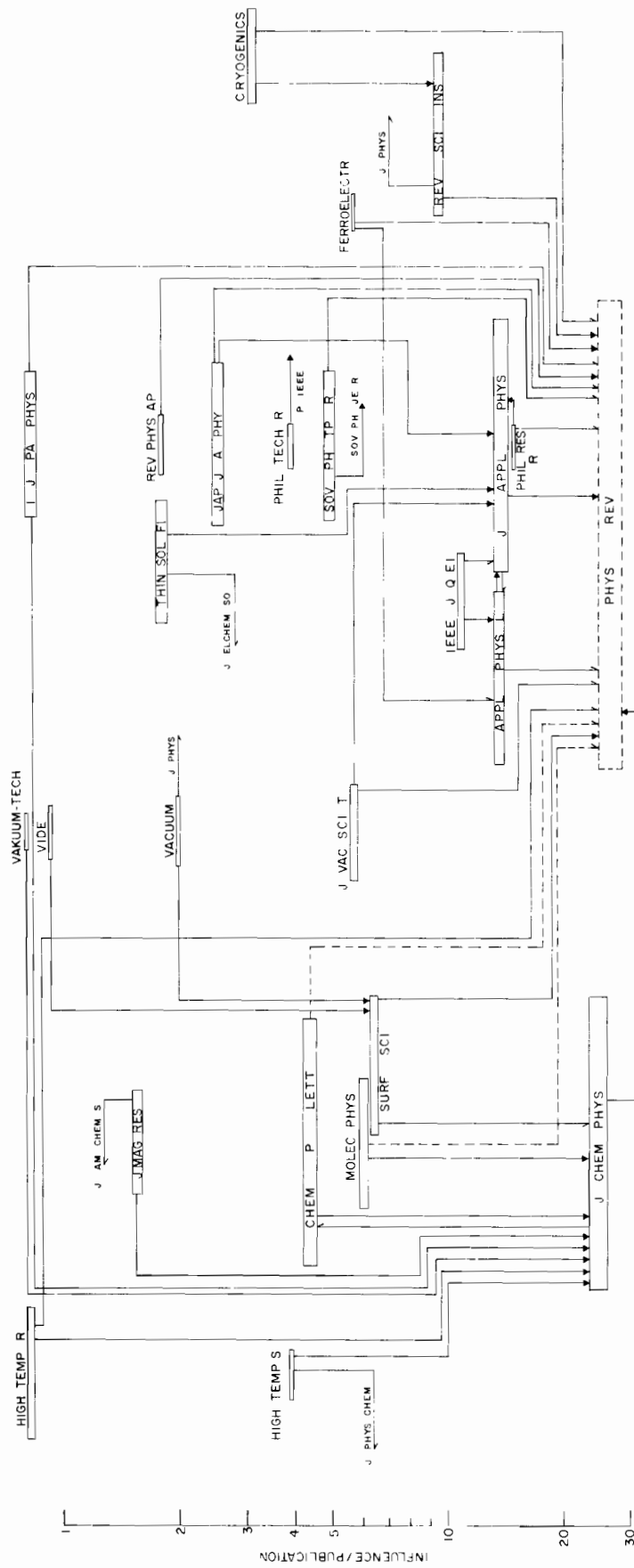

FIGURE 7-5

INFLUENCE MAP FOR CHEMICAL AND APPLIED PHYSICS JOURNALS

These influence maps provide a very graphic means of perceiving the influence relationships between the journals of physics. The next chapter contains the influence maps for all other fields covered by the SCI in 1973.

VIII. INFLUENCE MAPS

This chapter presents influence maps by field and subfield for all of the major journals. The first half of the chapter presents the non-biomedical maps, using the mapping conventions described in Section E of the previous chapter.

The second half of this chapter presents a subfield map for biomedicine, and the influence maps for the individual biomedical fields. There are a few minor differences in the drawing conventions for those maps, which will be noted before the maps are presented.

A. Non-Biomedical Maps

The maps for physics journals were presented in Chapter VII.

1. Biology

Most biological journals are associated with a subfield or sub-subfields. Unlike the fields of physics and chemistry where the largest and most influential journals are general journals, there are relatively few general biology journals.

The biological subfields are covered by six individual maps. They are:

- Figure 8-1: Influence Map for Zoology Journals
- Figure 8-2: Influence Map for Entomology Journals
- Figure 8-3: Influence Map for Botany Journals
- Figure 8-4: Influence Map for Food and Agriculture
and Dairy and Animal Science Journals
- Figure 8-5: Influence Map for Ecology Journals
- Figure 8-6: Influence Map for Marine Biology and
Oceanography Journals.

The most striking feature of the influence map for zoology journals, Figure 8-1, is the absence of a central journal. The general zoology and comparative bioscience journals do not have any common referencing pattern. There are specialized journals corresponding to various levels in a hierarchical classification scheme. Thus there are journals at the level of the biological Class dealing, for example, with birds, reptiles or mammals and at the level of Order, e.g., primate journals. The subset of ornithology journals appears at the left of the zoology maps, and forms a self-citing cluster.

Entomology, another subfield of zoology at the level of Class, is represented by so many journals that it stands as a full subfield within the biological literature. In the map for

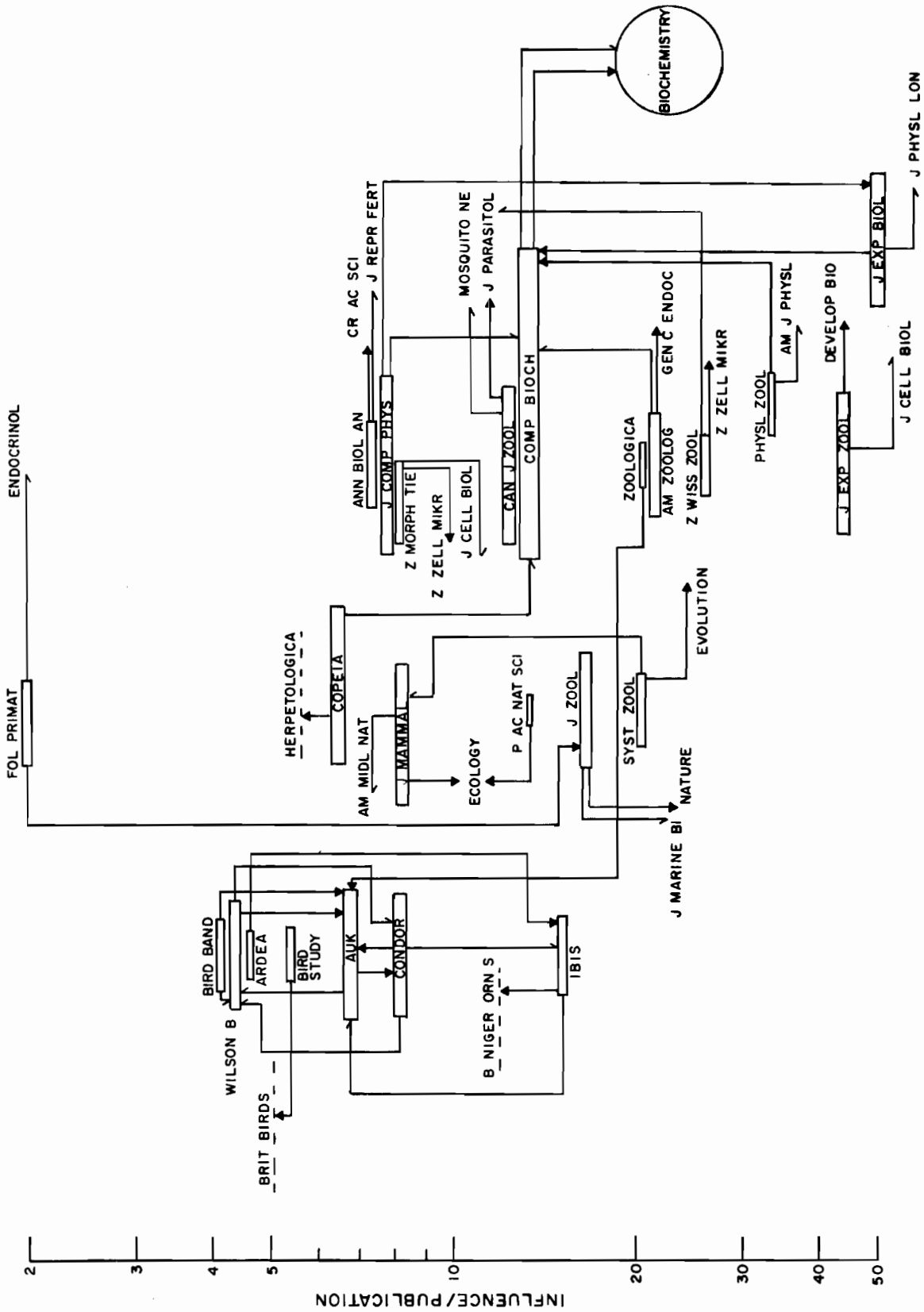

FIGURE 8-1
INFLUENCE MAP FOR ZOOLOGY JOURNALS

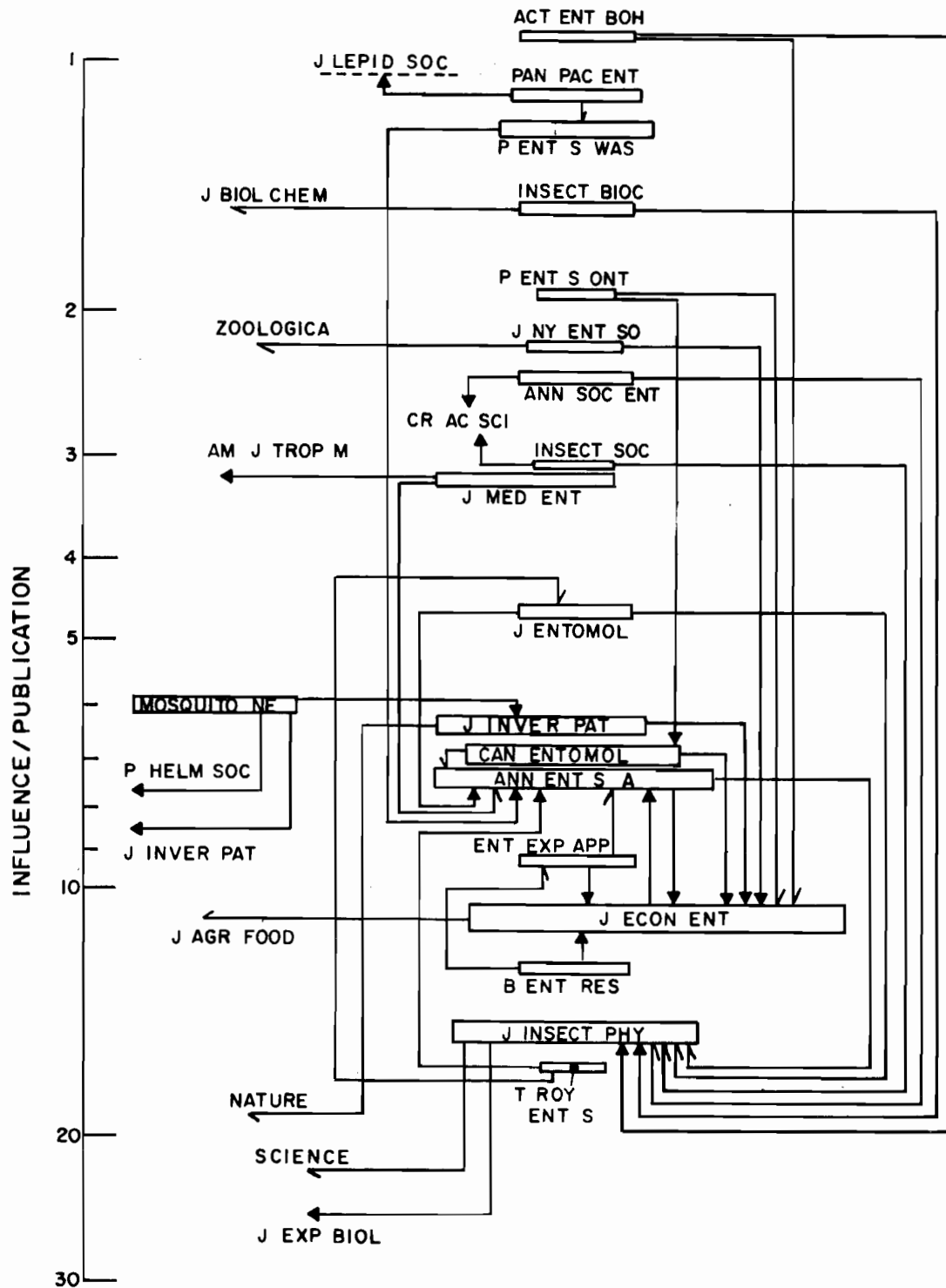

FIGURE 8-2

INFLUENCE MAP FOR ENTOMOLOGY JOURNALS

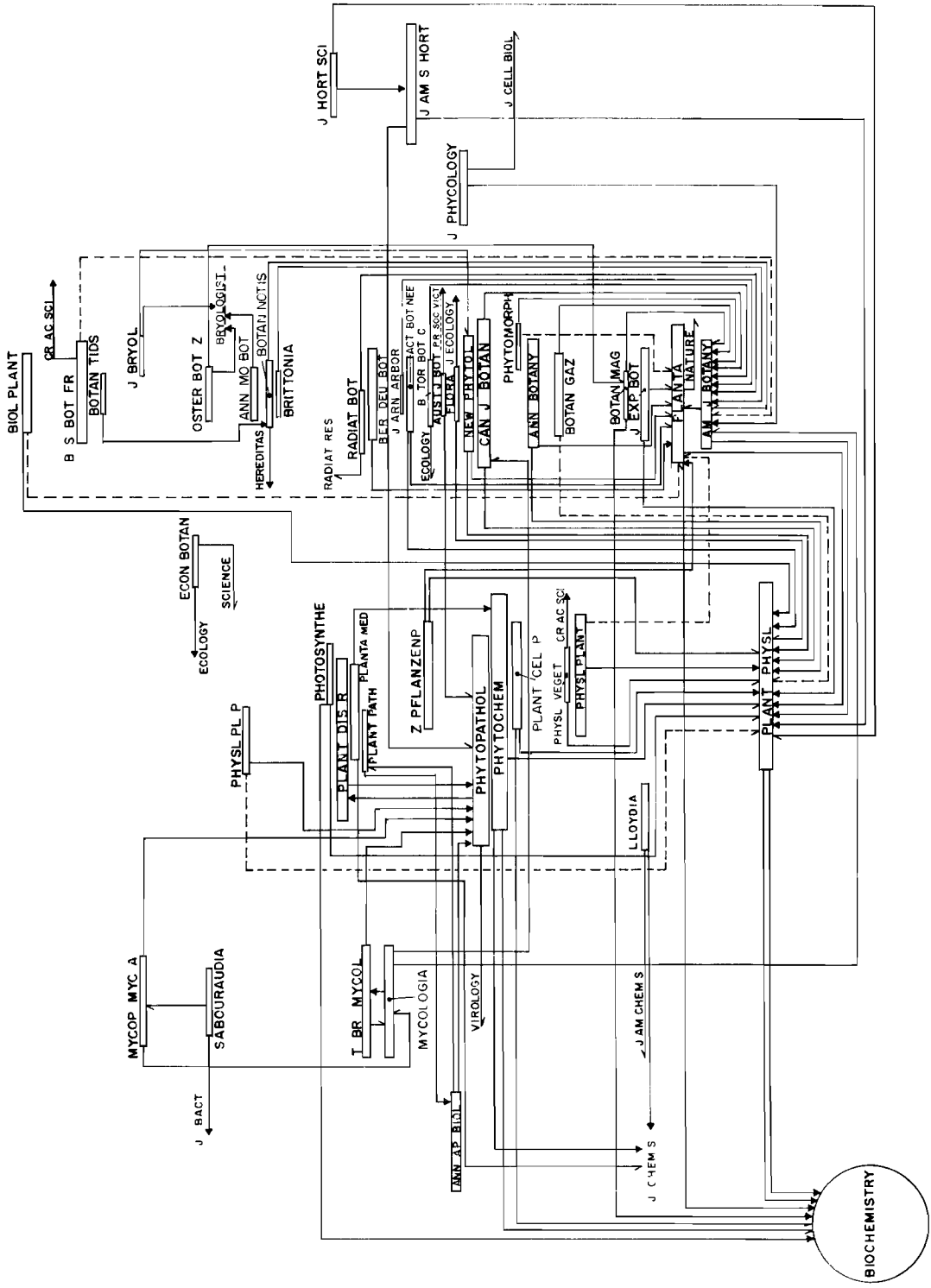
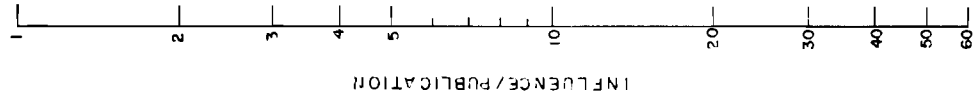

FIGURE 8-3

INFLUENCE MAP FOR BOTANY JOURNALS

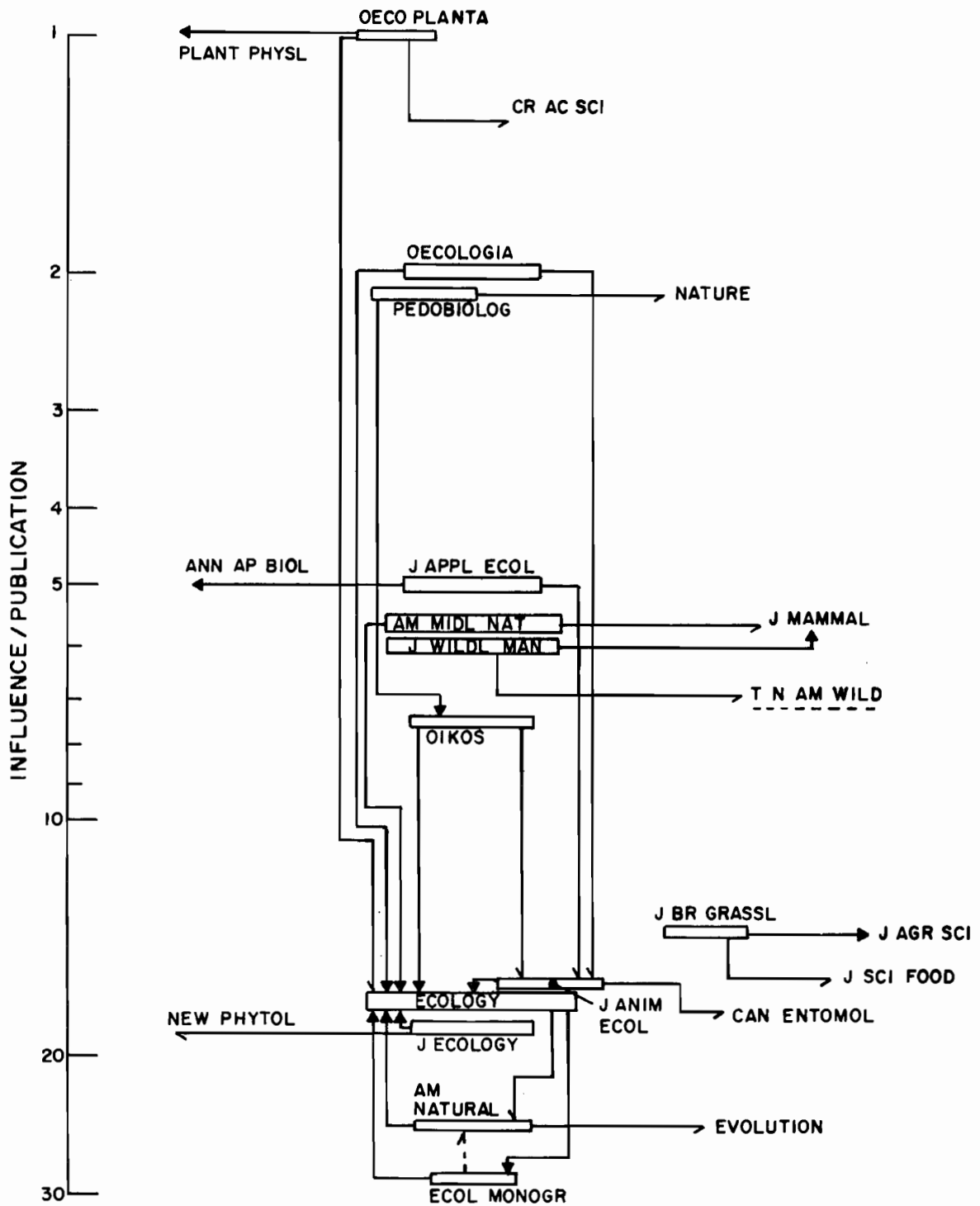

FIGURE 8-5

INFLUENCE MAP FOR ECOLOGY JOURNALS

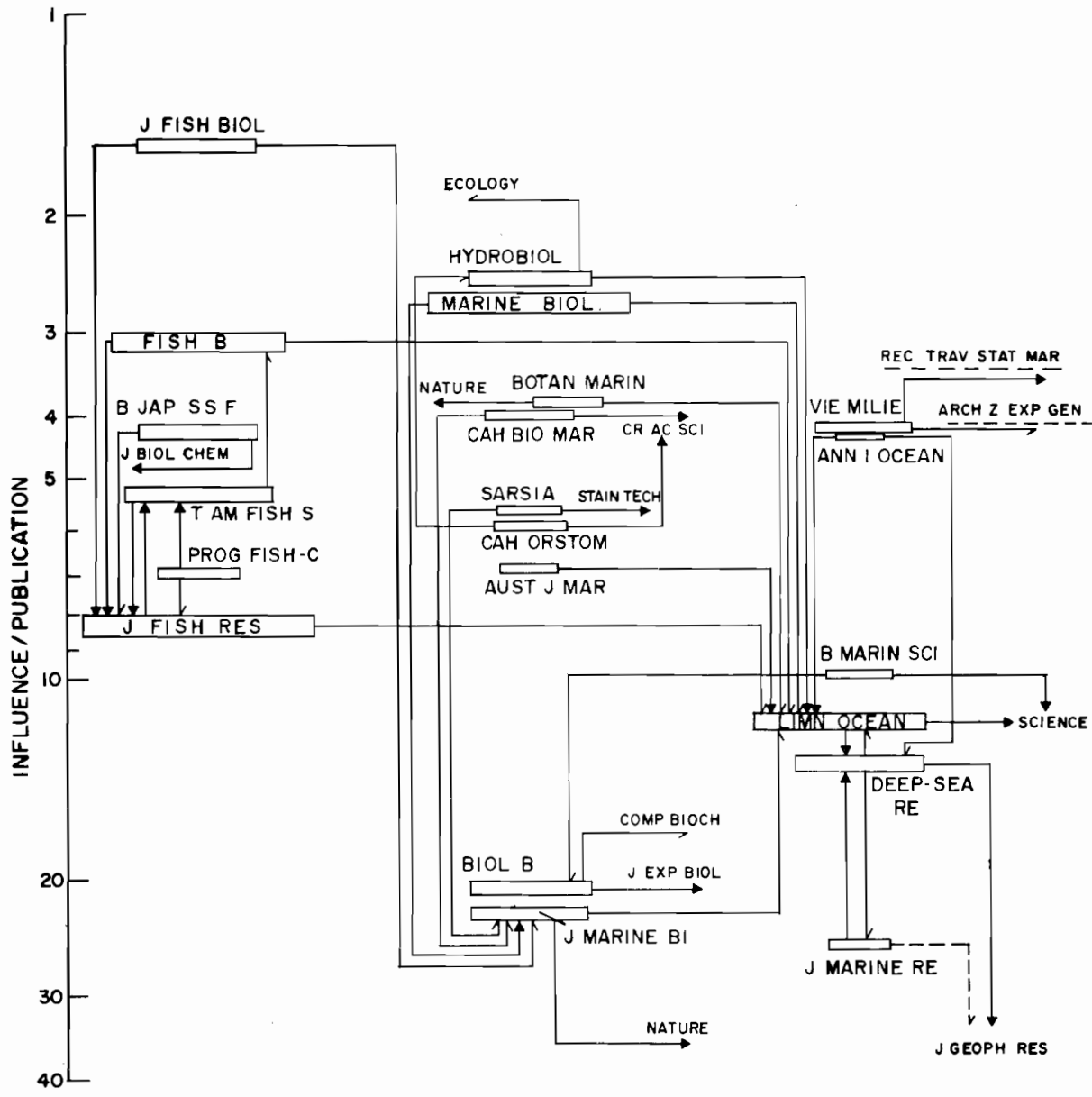

FIGURE 8-6

INFLUENCE MAP FOR MARINE BIOLOGY AND OCEANOGRAPHY JOURNALS

entomology journals, Figure 8-2, several central journals appear. The large Journal of Economic Entomology is important not only within entomology but also within agricultural science.

Botany and plant science journals appear in Figure 8-3. The American Journal of Botany and Plant Physiology are both central journals with the latter being highly cited by both basic plant science journals and by botany journals. There is also a high level of referencing from basic plant science journals to the field of biochemistry.

The fields of agriculture and food science and of dairy and animal science may be regarded as part of applied biology. The map for journals in these areas is given in Figure 8-4. Subfields such as soil science, dairy science, and poultry science are highly self-citing and have obvious central journals. Biochemistry journals are frequently cited by many of the journals on this map.

Ecology journals appear in Figure 8-5. Although the journal Ecology is central to the field, referencing from ecology journals is widely dispersed.

Marine biology is a subfield of biology while oceanography has been classified under earth science. However, much oceanographic research is concerned with marine life. Therefore, the large overlap occurring between the two subfields, marine biology and oceanography, cuts across the major-field boundaries. Journal influence weights calculated using citation data only within the major field were not considered to give valid measures for journals within either of these subfields. In the map for marine biology and oceanography journals, Figure 8-6, unweighted citation per publication values were used as the influence measure. The importance of the journal Limnology and Oceanography to the marine biology journals is evident.

2. Chemistry

This section presents the six influence maps for the field of chemistry, which is divided into

- Figure 8-7: Influence Map for General Chemistry Journals
- Figure 8-8: Influence Map for Organic Chemistry Journals
- Figure 8-9: Influence Map for Inorganic and Nuclear Chemistry Journals
- Figure 8-10: Influence Map for Analytical Chemistry Journals
- Figure 8-11: Influence Map for Physical Chemistry Journals
- Figure 8-12: Influence Map for Applied and Polymer Chemistry Journals

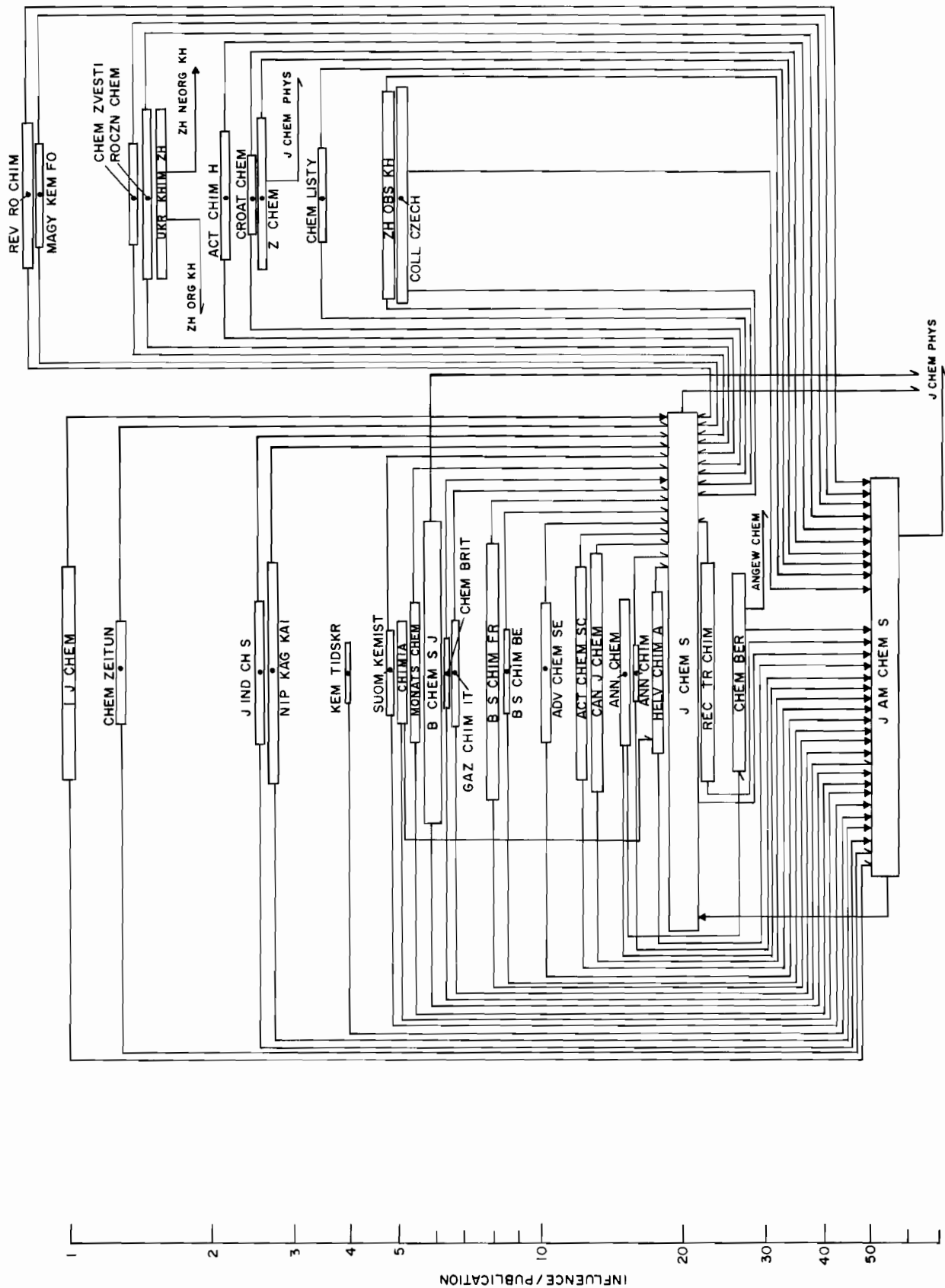

FIGURE 8-7

INFLUENCE MAP FOR GENERAL CHEMISTRY JOURNALS

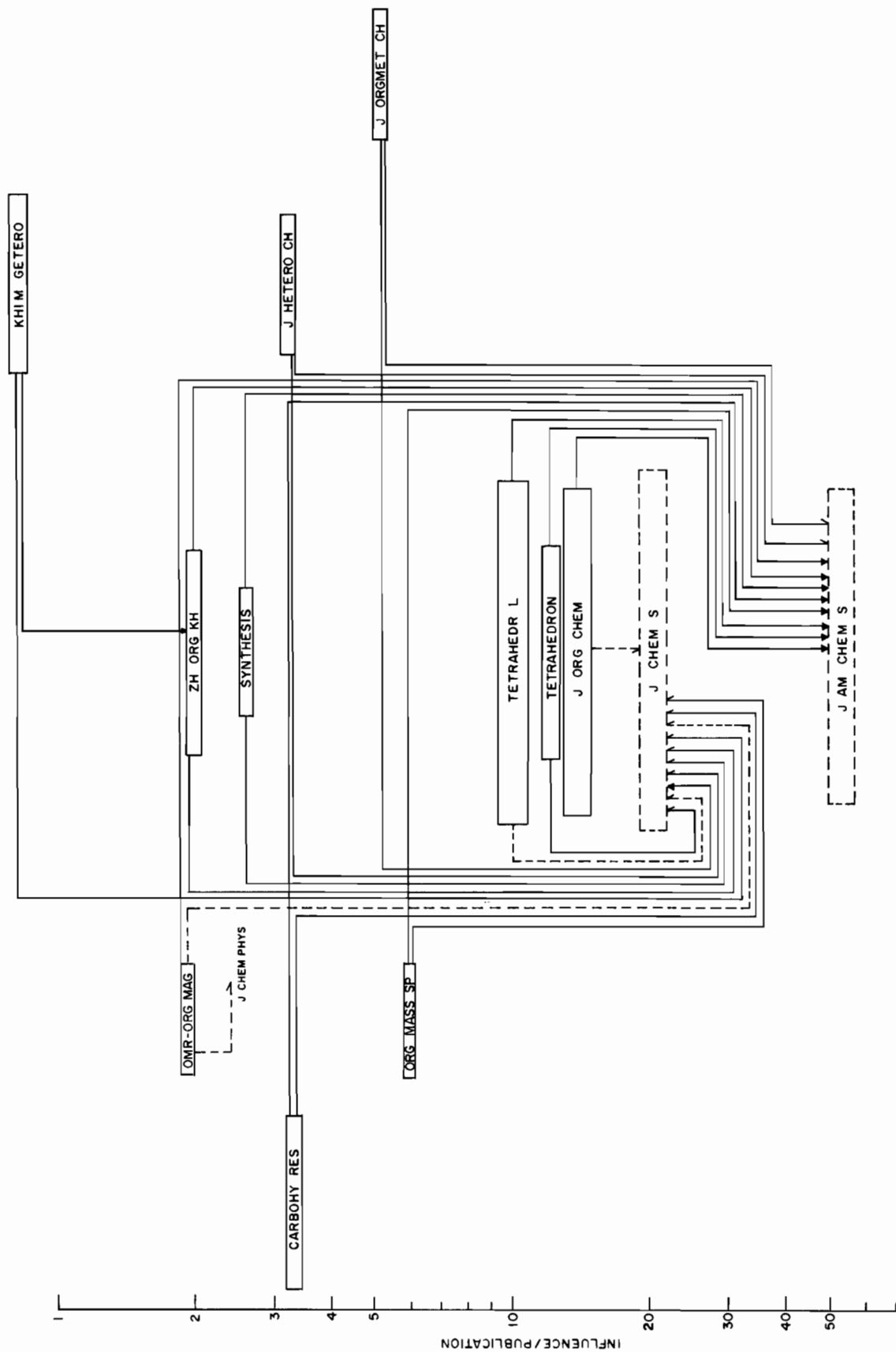

FIGURE 8-8

INFLUENCE MAP FOR ORGANIC CHEMISTRY JOURNALS

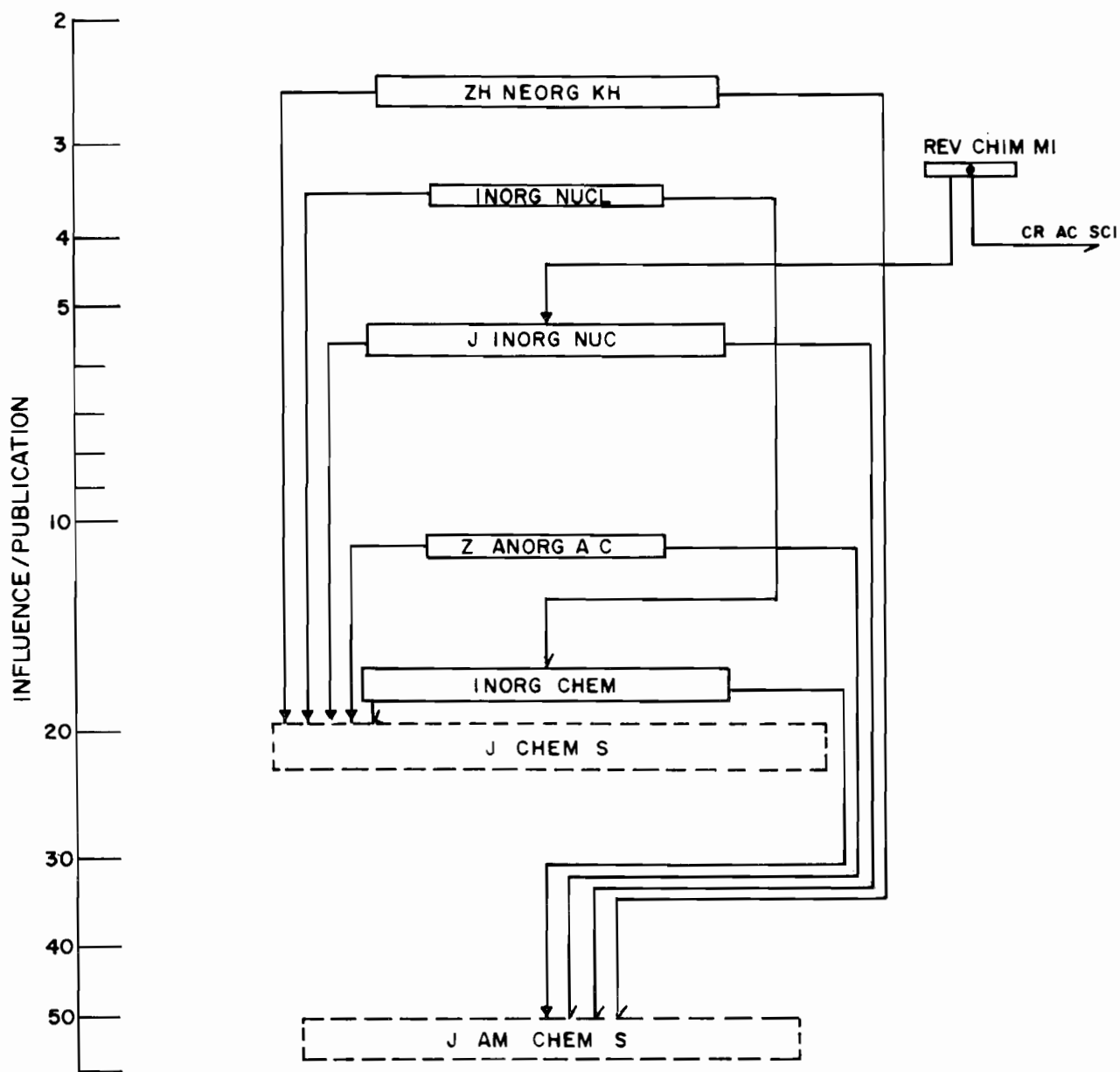

FIGURE 8-9

INFLUENCE MAP FOR INORGANIC AND NUCLEAR CHEMISTRY JOURNALS

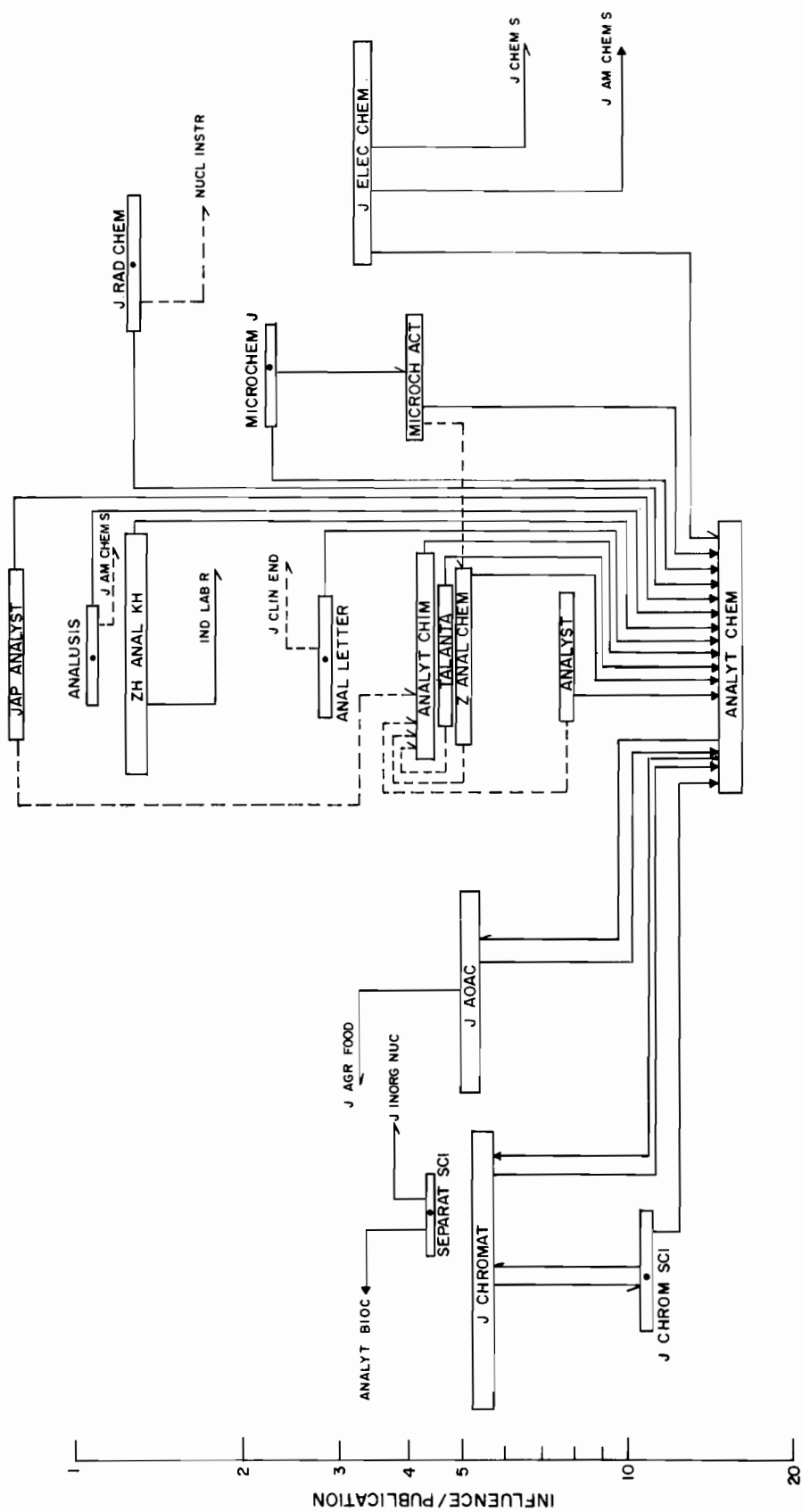

FIGURE 8-10

INFLUENCE MAP FOR ANALYTICAL CHEMISTRY JOURNALS

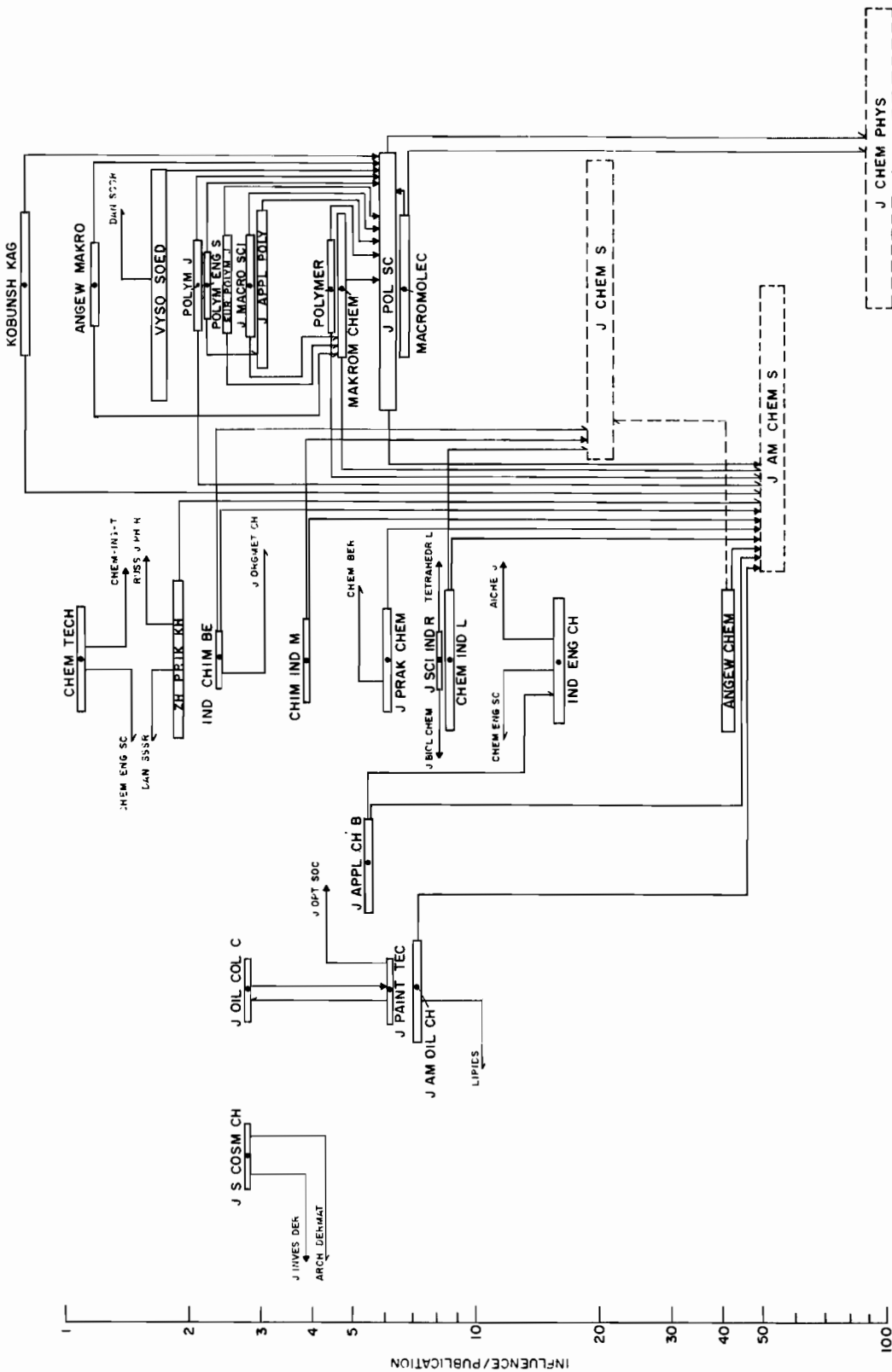

FIGURE 8-12

INFLUENCE MAP FOR APPLIED AND POLYMER CHEMISTRY JOURNALS

Figure 8-7 is the map for general chemistry journals. All sections of the Journal of the Chemical Society have been combined into a single unit which must then be considered a general journal. The standard pattern for general chemistry journals is to refer most frequently to the Journal of the American Chemical Society and second to the Journal of the Chemical Society. The journals have been placed into two columns, with the Eastern European countries appearing at the right.

The organic chemistry journals, shown in Figure 8-8, and the inorganic and nuclear chemistry journals, shown in Figure 8-9, also refer most frequently to the two large general journals. This referencing pattern may be contrasted with the referencing pattern shown in the map for analytical chemistry journals, Figure 8-10, where it is apparent that a higher percentage of the references remain within the subfield, with Analytical Chemistry being the central journal.

Physical chemistry journals including crystallography, spectroscopy and electrochemistry journals are mapped in Figure 8-11. The most striking feature of this map is the importance of the Journal of Chemical Physics, which is itself a borderline journal between chemistry and physics.

In Figure 8-12, applied and polymer physics journals are shown. The Journal of Polymer Science (a combination of the individual sections) is the central polymer journal. The applied chemistry grouping does not form a cohesive citation unit, but refers to a variety of basic chemistry and chemical engineering journals.

3. Earth and Space Science

This section presents the earth and space science influence maps, which are:

Figure 8-13: Influence Map for Astronomy
and Astrophysics Journals

Figure 8-14: Influence Map for Geoscience
Journals.

Astronomy and astrophysics journals, which were classified under earth and space science rather than under physics, are mapped in Figure 8-13. There is a high percentage of citation within the subfield, with the Astrophysical Journal being the dominant journal. The journal Nature obviously plays an important role.

Figure 8-14 presents a panoramic view of the geoscience journals. The larger groupings include those of meteorology, geophysics, geology and mineralogy. The Journal of Geophysical Research is a central journal for all of these subfields.

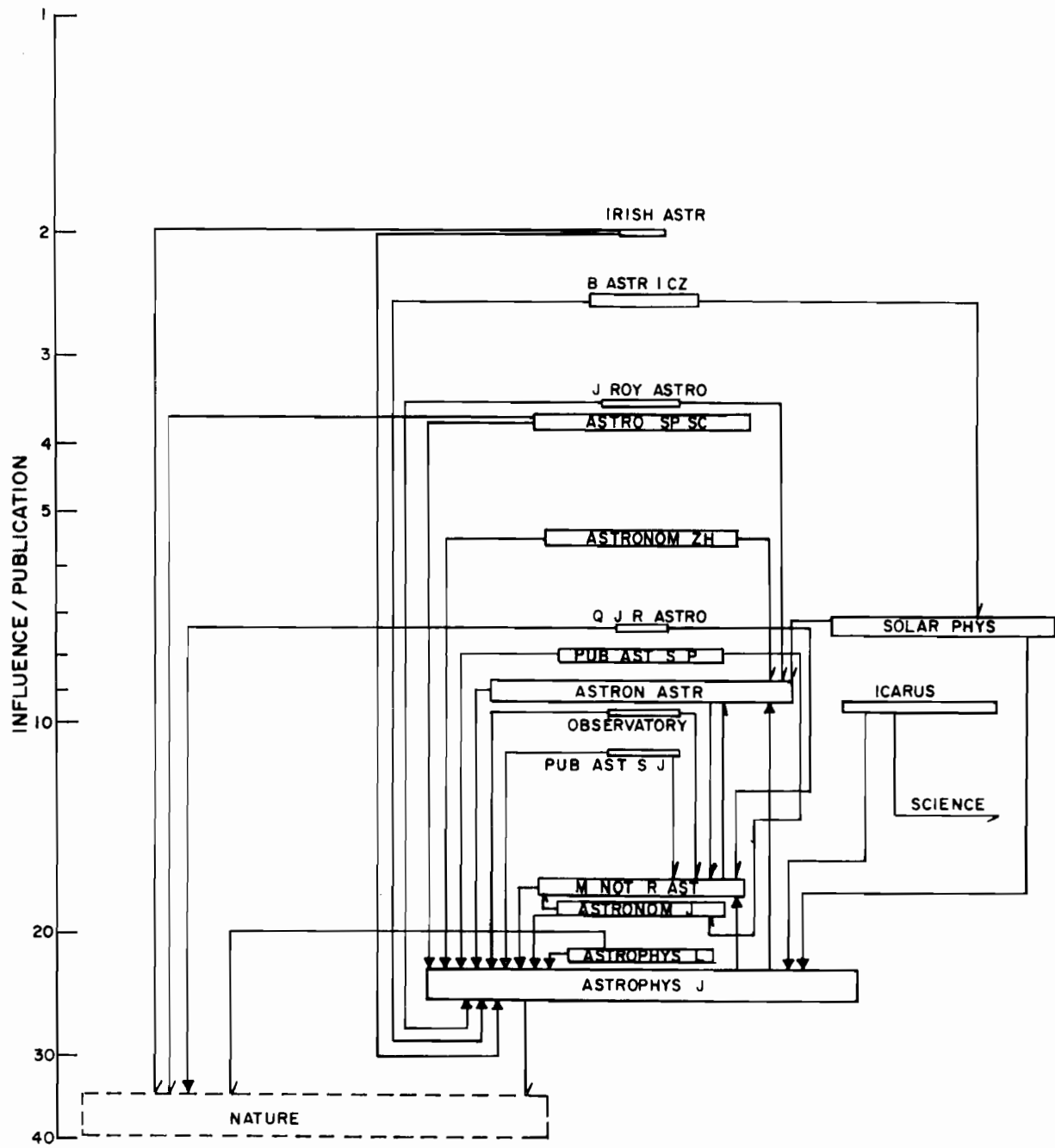

FIGURE 8-13

INFLUENCE MAP FOR ASTRONOMY AND ASTROPHYSICS JOURNALS

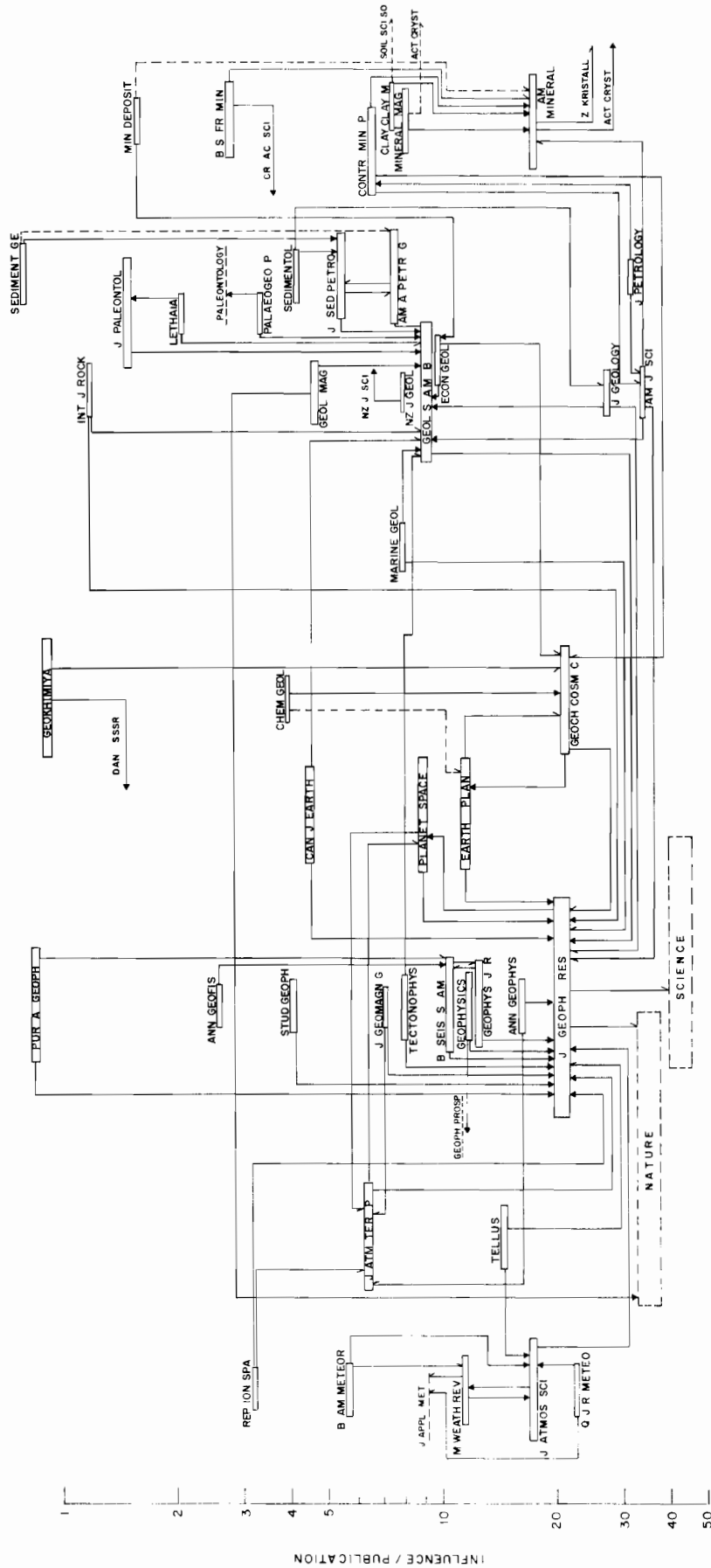

FIGURE 8-14

INFLUENCE MAP FOR GEOSCIENCE JOURNALS

4. Mathematics

In this section two influence maps are presented which cover the field of mathematics. These are

Figure 8-15: Influence Map for General,
Applied and Miscellaneous
Mathematics Journals

Figure 8-16: Influence Map for Probability
and Statistics Journals.

Figure 8-15 includes general, applied and miscellaneous mathematics journals. The general journals, broken down by nationality, appear in four columns. The U.S. journals are at the center of the figure, with British and Canadian journals to the left, European journals to the right, except for the German journals (East and West) which are separated and placed further to the right. The pattern of a field having a large central journal, which is typical of the physical, chemical and biomedical fields, is not followed in mathematics. The small, elite, Annals of Mathematics not only has the highest influence per publication, but also the highest total influence.

At the left of the figure are the applied journals, which do not have any common referencing pattern.

Probability and statistics journals, which cite heavily within their own subfield, are mapped in Figure 8-16. The most highly cited journals are Biometrika and the Annals of Mathematical Statistics.

5. Psychology

Journals in all subfields of psychology are mapped in Figure 8-17. In the large column to the left of center are the general psychology journals. To the left are the social and personality journals with the clinical journals at the far left. To the right are experimental psychology and behavioral research journals with child and developmental psychology journals further to the right. As in the field of mathematics, the most highly cited journals are not necessarily the largest.

6. Engineering and Technology

In this section the eight maps which include the subfields of engineering and technology are presented. These are

Figure 8-18: Influence Map for Electrical
Engineering and Computer
Science Journals

Figure 8-19: Influence Map for Mechanical
Engineering and Aerospace
Technology Journals.

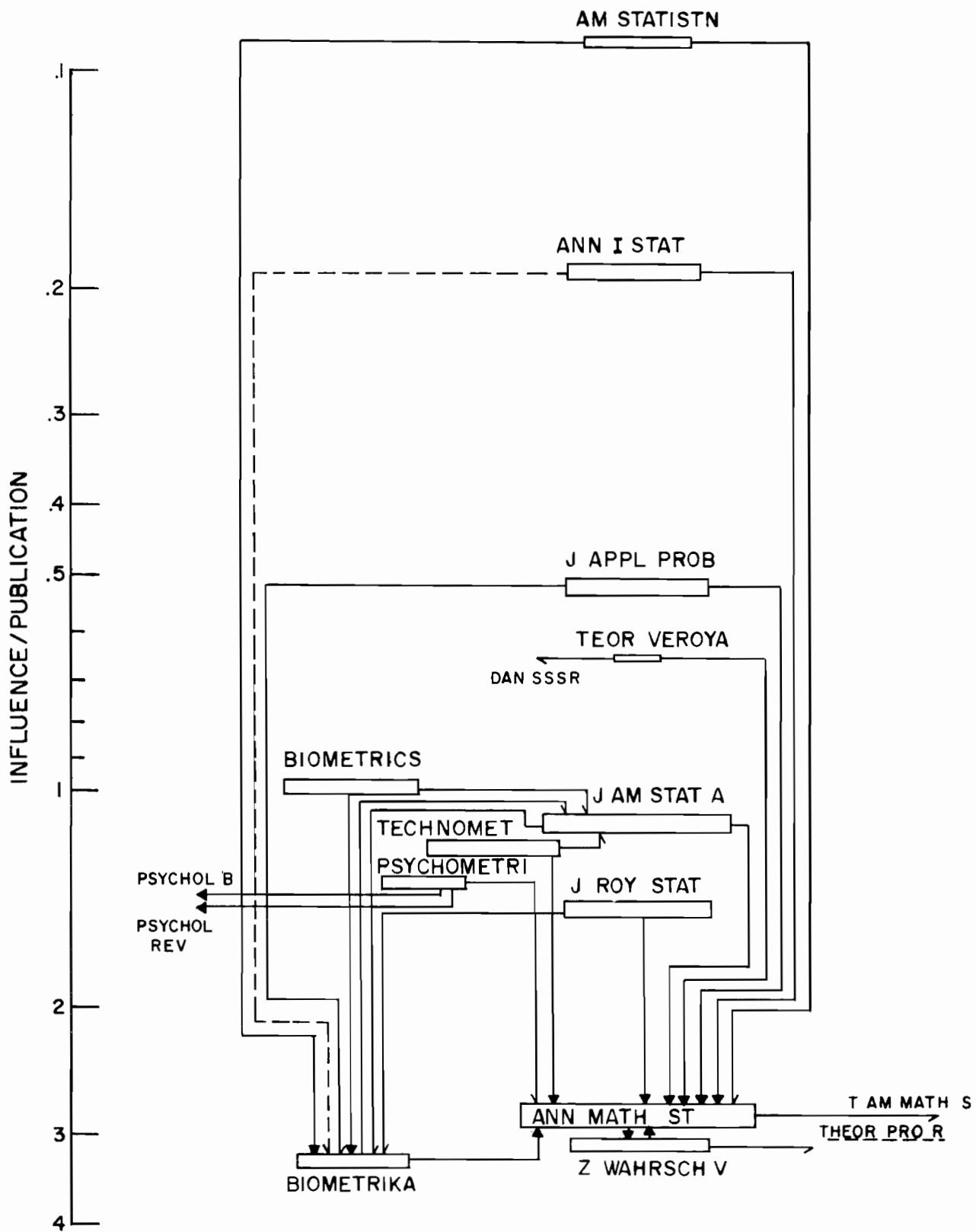

FIGURE 8-16

INFLUENCE MAP FOR PROBABILITY AND STATISTICS JOURNALS

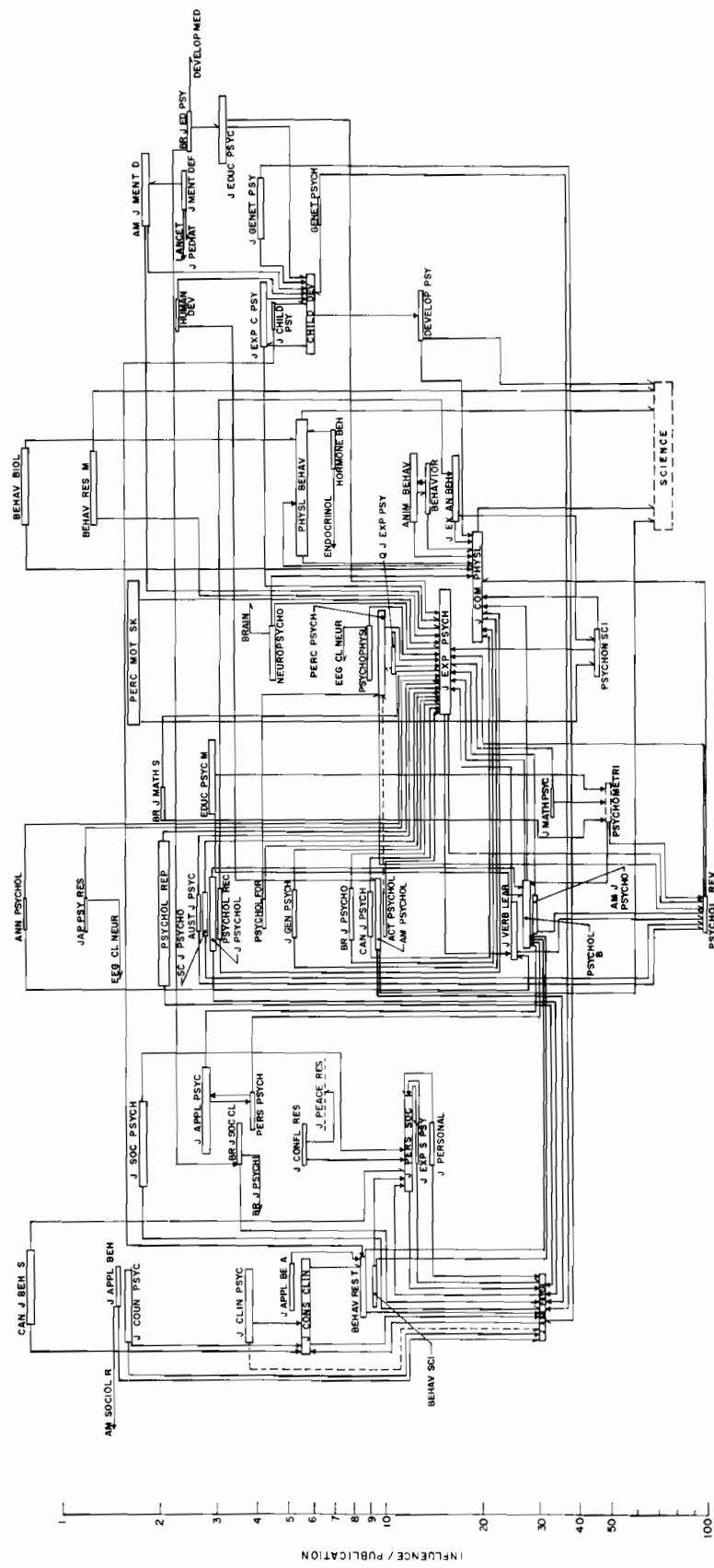

FIGURE 8-17

INFLUENCE MAP FOR PSYCHOLOGY JOURNALS

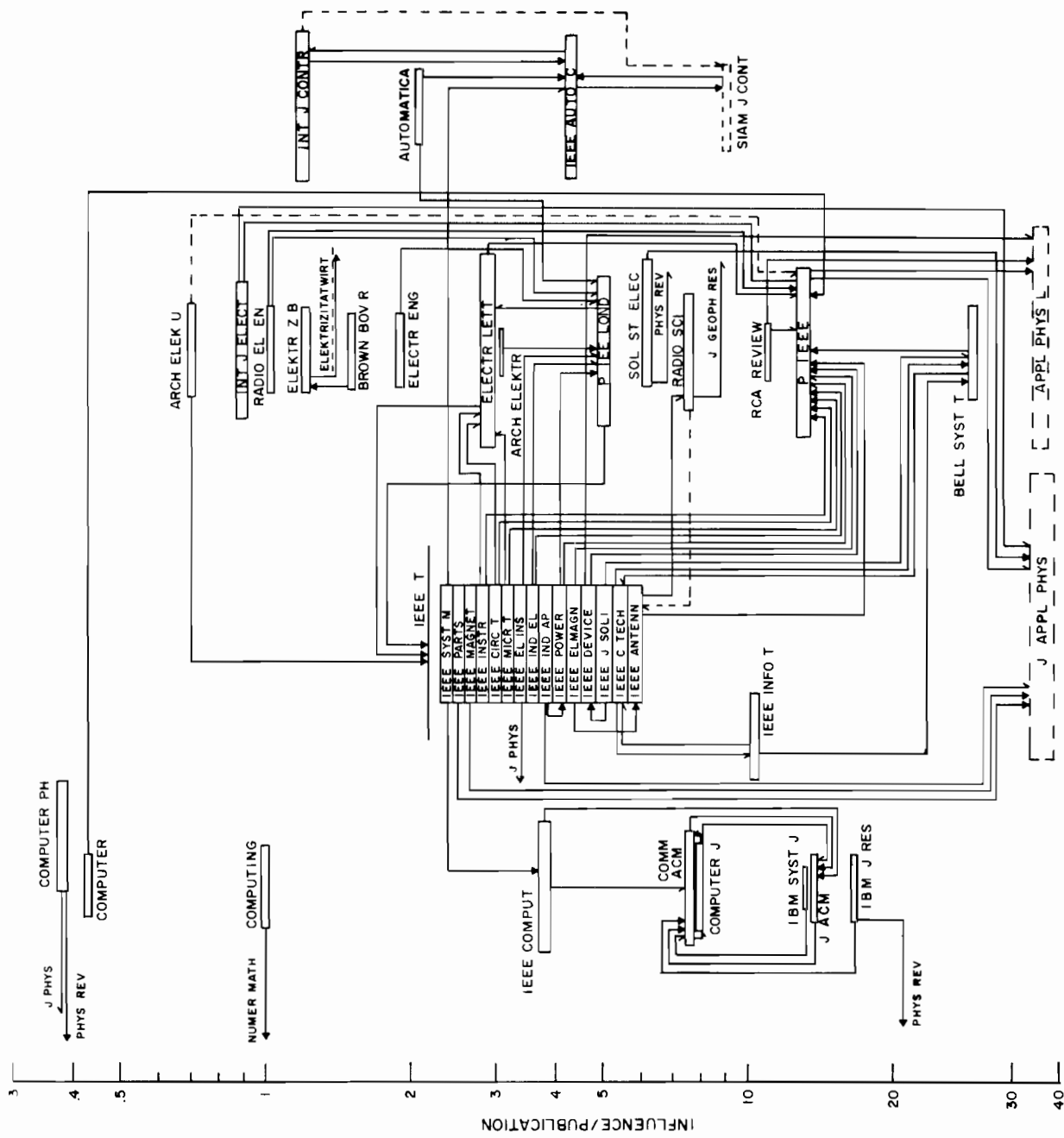

FIGURE 8-18

INFLUENCE MAP FOR ELECTRICAL ENGINEERING AND COMPUTER SCIENCE JOURNALS

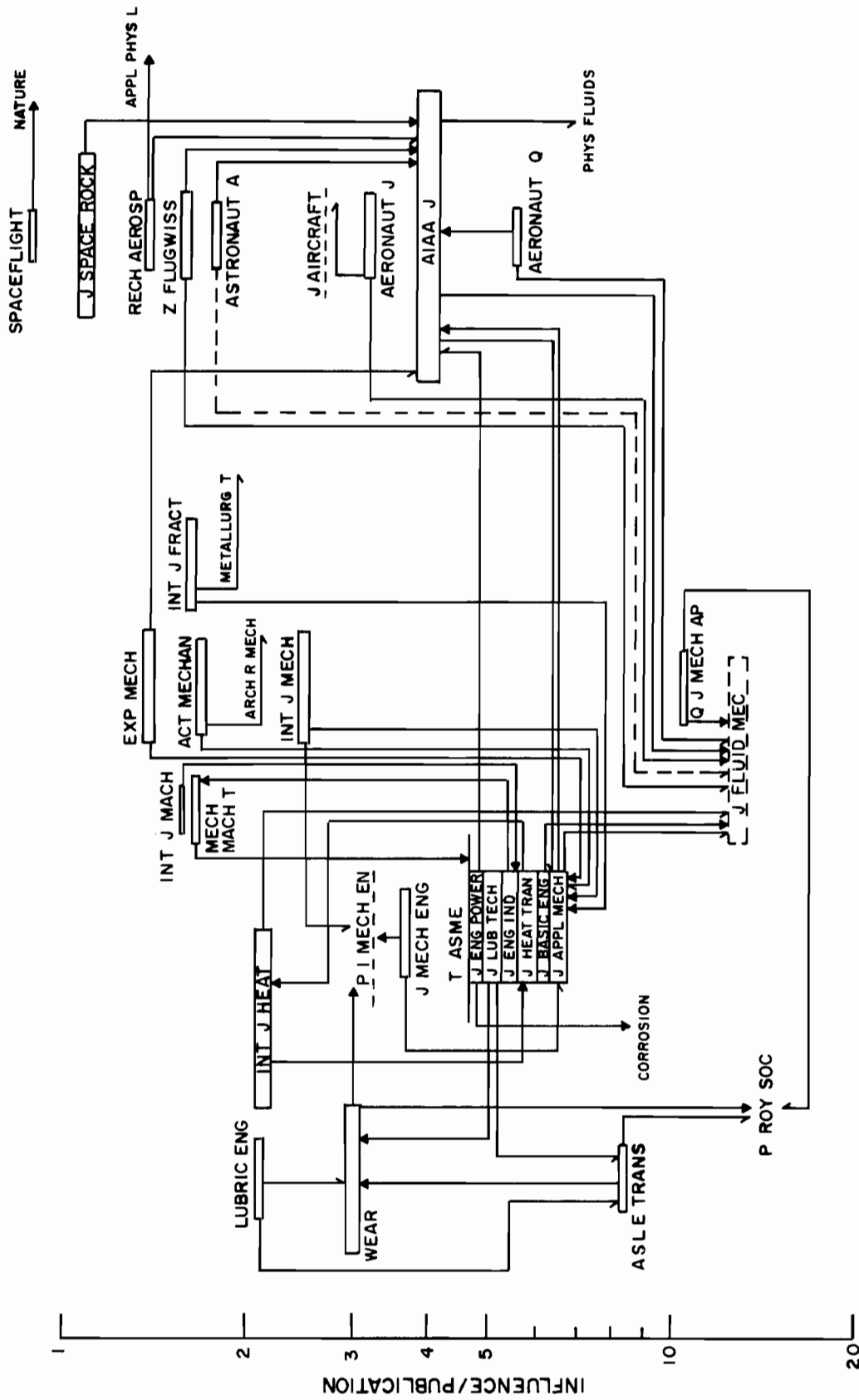

FIGURE 8-19
 INFLUENCE MAP FOR MECHANICAL ENGINEERING AND AEROSPACE TECHNOLOGY JOURNALS

- Figure 8-20: Influence Map for Civil Engineering Journals
- Figure 8-21: Influence Map for Nuclear Technology Journals
- Figure 8-22: Influence Map for Chemical Engineering Journals
- Figure 8-23: Influence Map for Metals and Metallurgy Journals
- Figure 8-24: Influence Map for Materials Science Journals
- Figure 8-25: Influence Map for Operations Research, Library and Information Science Journals.

Citation data for journals in the subfields of engineering and technology are poorer than citation data for journals in the subfields of pure science. There were many journals for which the number of references linking them with other journals covered by the SCI was too small to allow them to participate in the weighting scheme. These journals do not appear on the influence maps. There is also the problem of distinguishing sections of a journal issued in many parts.

The electrical engineering and computer science journals appear in Figure 8-18. There are more than 30 sections of the Transactions of the IEEE, of which only a few were considered separately; the rest were combined into "IEEE T". Applied physics journals are cited frequently by electrical engineering journals.

Figure 8-19 includes mechanical engineering and aerospace technology journals. The Transactions of the ASME were the most highly cited mechanical engineering journals, but again it was not possible to separate the specific sections from an undifferentiated form which we call "T ASME". The large AIAA Journal dominates the aerospace field. Journals in both these subfields refer frequently to the Journal of Fluid Mechanics which has been classified under physics.

The small map of civil engineering journals, Figure 8-20, suffers from the fact that the SCI did not start covering the journals of the American Society of Civil Engineers, until 1974; that is, the main U.S. civil engineering journals were not covered in 1973. The nuclear technology journals, shown in Figure 8-21, refer frequently to the Physical Review. In the chemical engineering map, Figure 8-22, the journals concerned with fuels are separated in the column at the right.

The map of metals and metallurgy, Figure 8-23, contains a main metallurgy column, with separate columns for corrosion, iron and steel, and for welding journals. The two journals central to the field are Metallurgical Transactions and Acta Metallurgica.

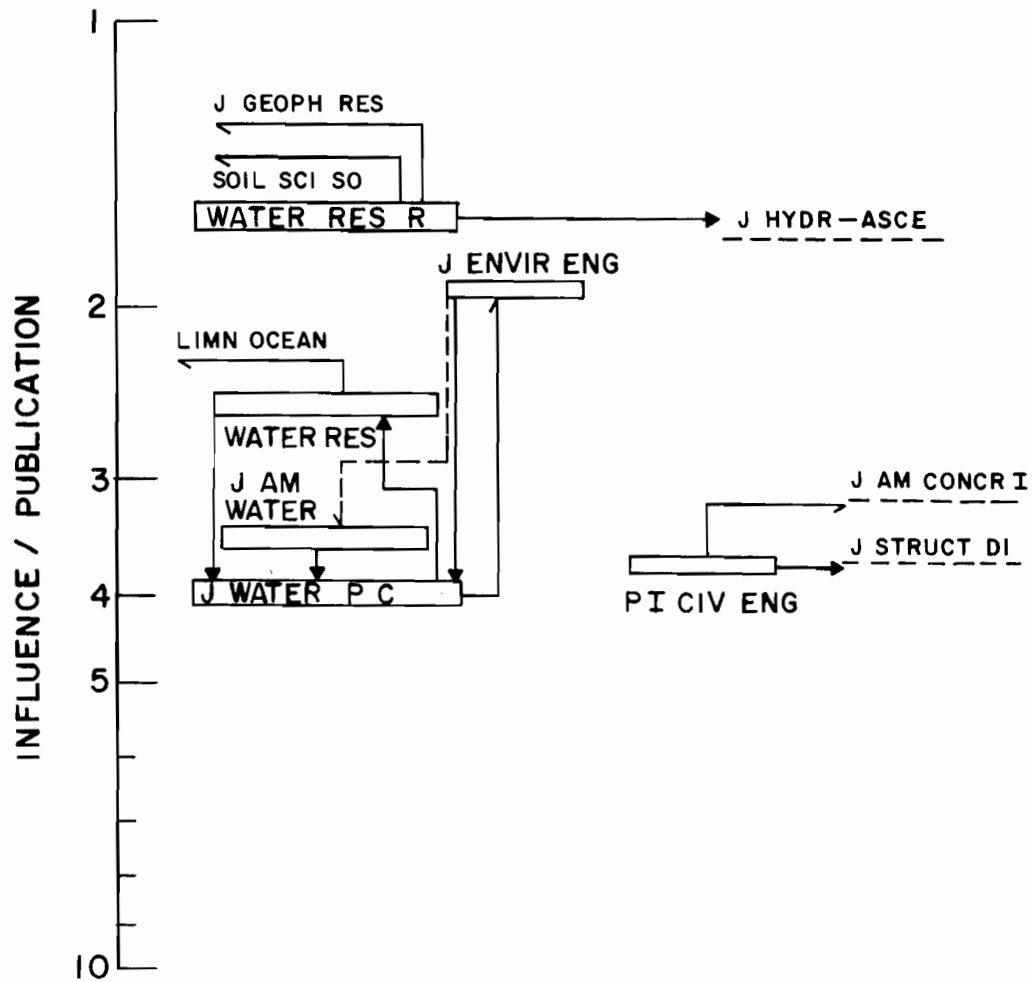

FIGURE 8-20

INFLUENCE MAP FOR CIVIL ENGINEERING JOURNALS

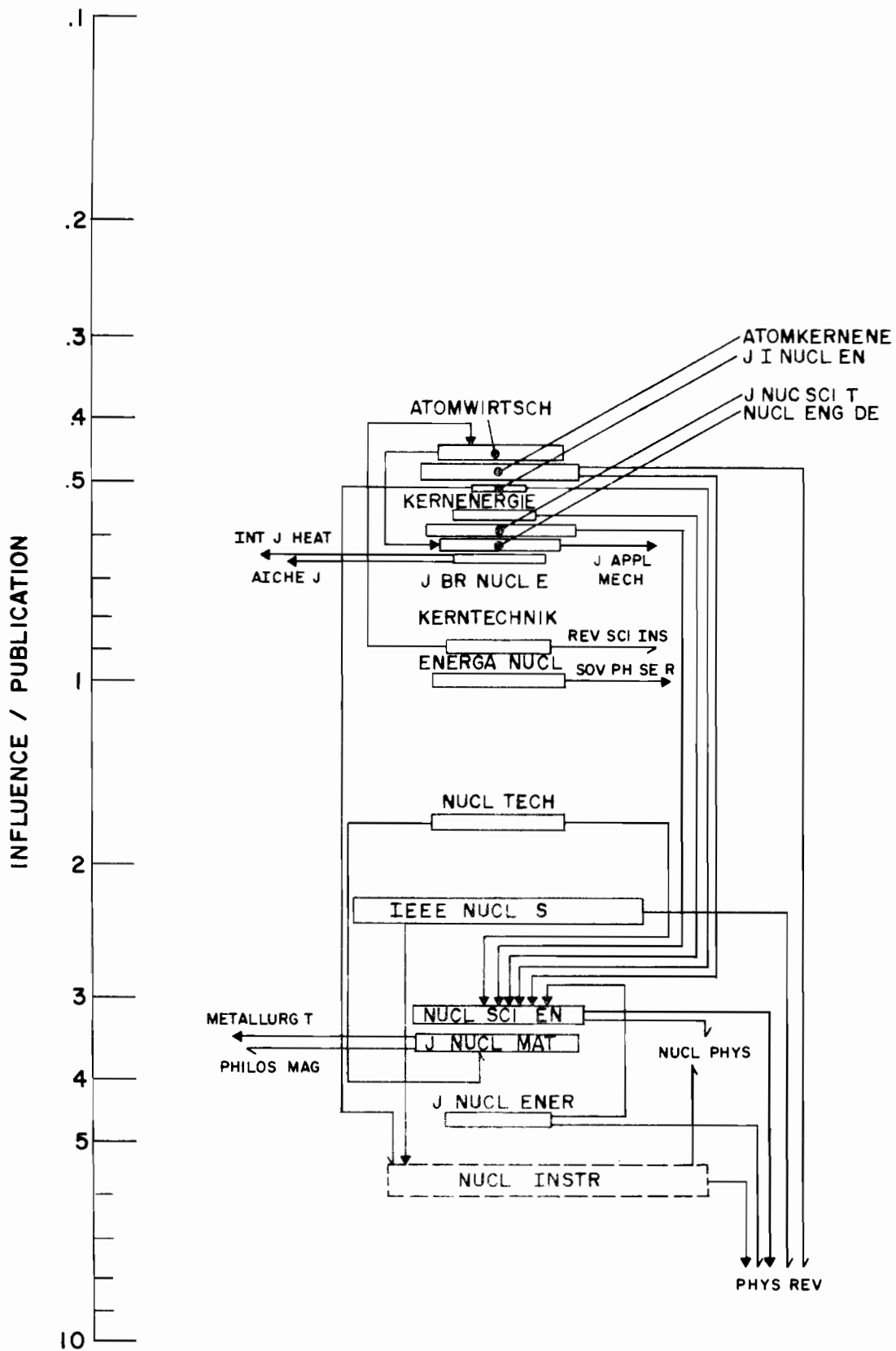

FIGURE 8-21

INFLUENCE MAP FOR NUCLEAR TECHNOLOGY JOURNALS

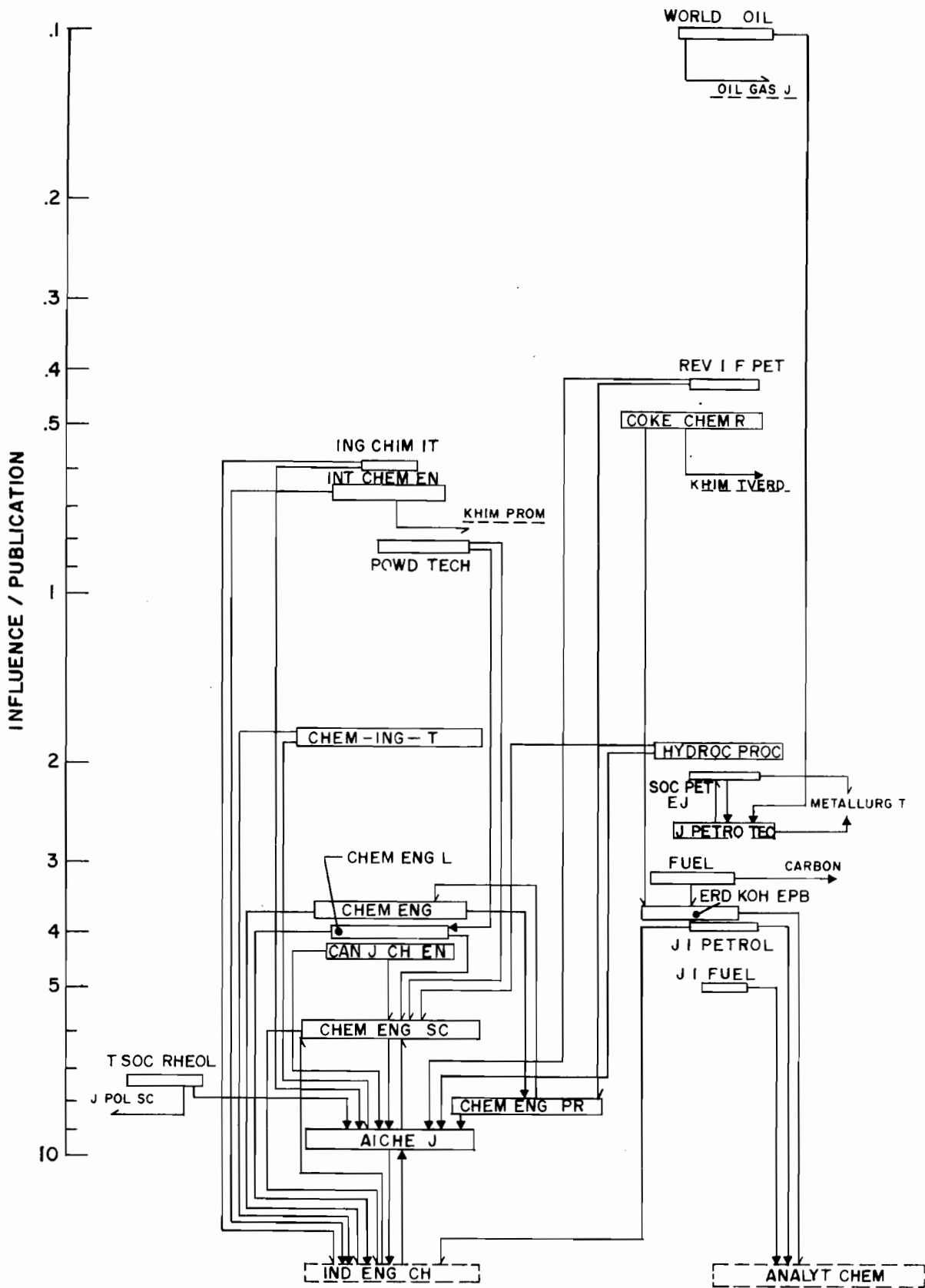

FIGURE 8-22

INFLUENCE MAP FOR CHEMICAL ENGINEERING JOURNALS

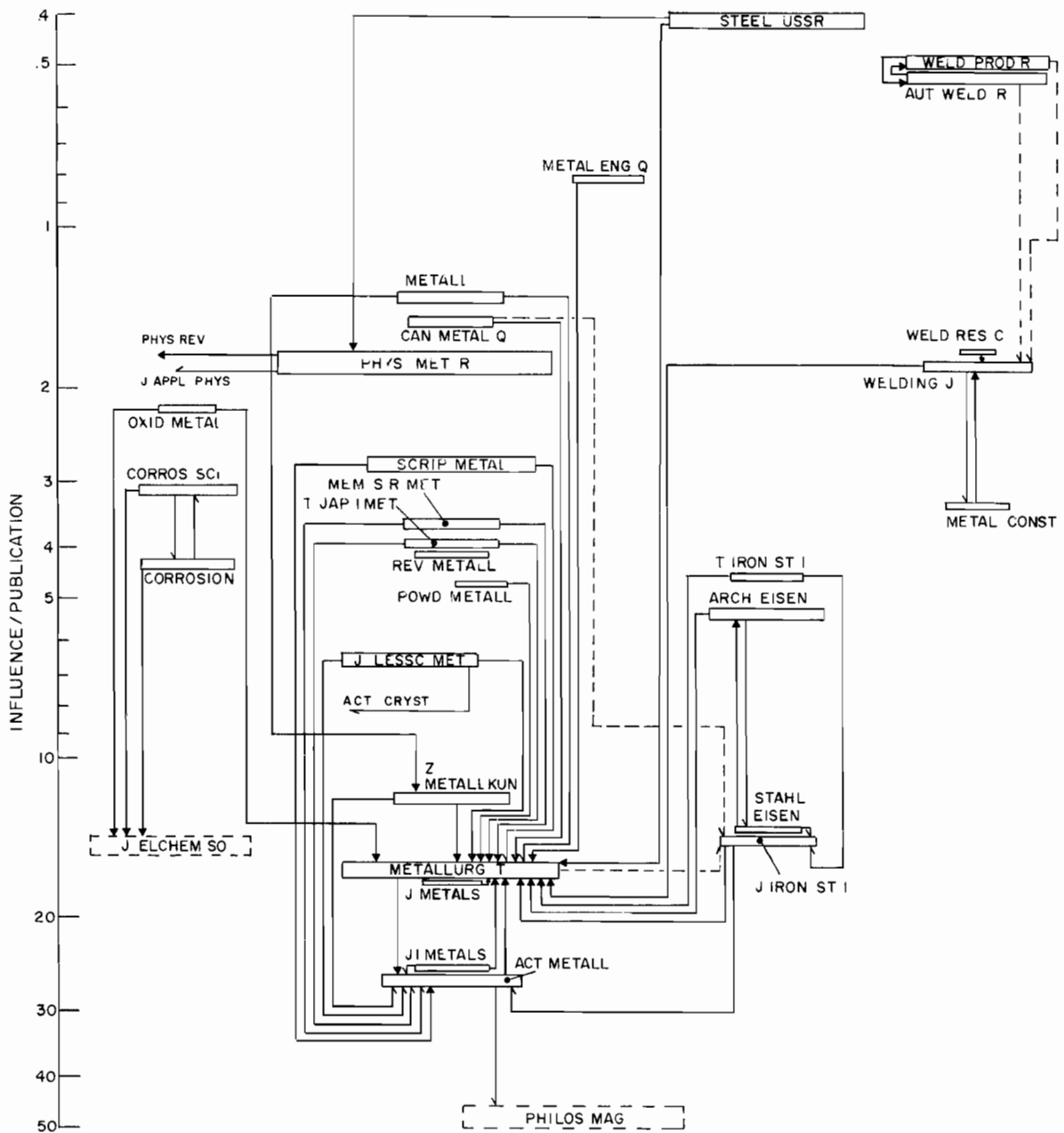

FIGURE 8-23

INFLUENCE MAP FOR METALS AND METALLURGY JOURNALS

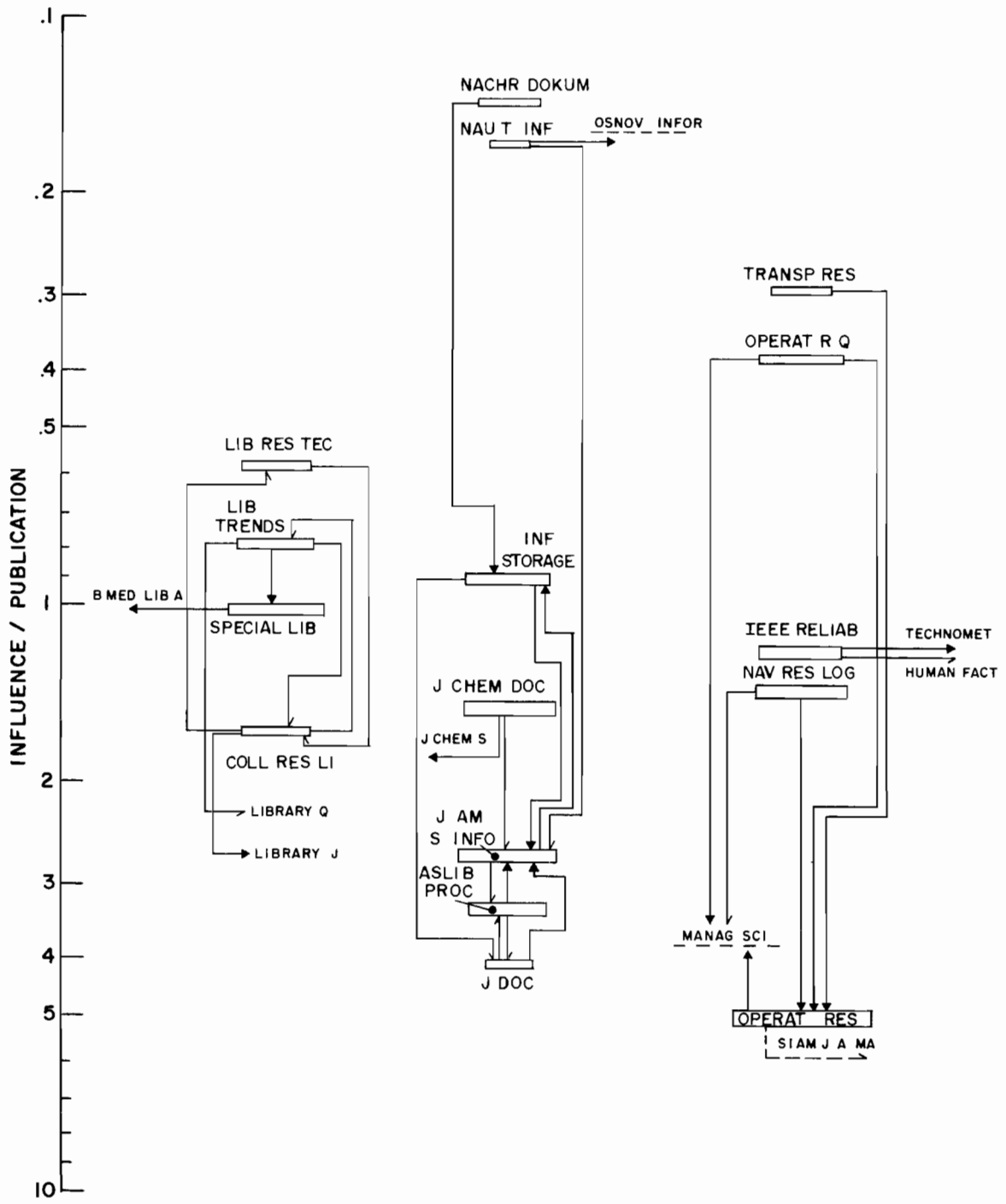

FIGURE 8-25
 INFLUENCE MAP FOR OPERATIONS RESEARCH,
 LIBRARY AND INFORMATION SCIENCE JOURNALS

The map for the subfield of materials science, Figure 8-24, consists of a series of disjoint segments corresponding to different materials dealt with by several journals covered by the SCI. There are separate columns for paper and wood, textile, and ceramics and glass journals. At the far left are three general materials science journals.

Figure 8-25 contains library, information science and operations research journals. One of the two leading operations research journals, Management Science was not covered by the SCI until 1974. There is little cross citation between the library journals and the information science journals. Citation data for the library journals are particularly poor.

B. Influence Maps for Biomedicine

1. Field Weighting and the Biomedical Structure Map

In this section the influence methodology is applied to biomedicine by aggregating the biomedical journals into their subfields in order to analyze the flow of influence among these subfields. To facilitate terminology, these subfields will be termed "fields" for biomedicine. The influence measures are listed in Appendix I, Table A-2. These measures are influence measures within the 975-journal biomedical set and do not reflect interactions with "outside world".

Except for the general and internal medicine category, the different levels within a field were taken together. Levels 1, 2, and 3 of general medicine were considered separately due to the large size of each level.

Three large multidisciplinary journals, Science, Nature and the Proceedings of the National Academy of Sciences (U.S.) were considered individually. Their subject matter includes all fields of biomedicine in addition to the physical sciences and mathematics. It is therefore not appropriate to include these journals within any specific biomedical field, nor to include them in the category of general biomedical research. However, their exceptional role in the biomedical literature necessitates their inclusion in the analysis. These three journals alone accounted for 15% of the references from the genetics-heredity category and 12% from immunology, a circumstance which should serve as a note of caution in the interpretation of the field influence weights. The weight derived for the genetics category applies not to the field of knowledge, genetics, but rather to the body of journals classed as genetics journals. It is probable that some of the most significant work in genetics is published not in the specific genetics literature but rather in the high prestige, widely circulated multidisciplinary journals.

There are two fields which emerge with by far the highest influence weights: biochemistry and physiology. These fields may be thought of as the fundamental source fields for biomedicine. This concept of fundamental source fields and other less influential, related fields suggests a diagrammatic representation of the biomedical research structure as the generalized hierarchy shown in Figure 8-26 (for the larger fields). The vertical coordinate for a field in the hierarchy is its influence weight. Biochemistry and physiology thus appear at the base of the hierarchy. Influence weights appear to be distributed in a log-uniform rather than a uniform manner. Use of a logarithmic scale thus leads to a clearer figure.

The horizontal coordinate in the two dimensional diagram arises from the following observation: there is a wide variation in the relative dependence of a given field upon the two base fields. For virology, the ratio:

References to biochemistry
References to physiology

is close to 100 while for anesthesiology this ratio is 0.37; for biochemistry it is 28 while for physiology it is 0.25. This ratio, taken as the horizontal coordinate for each field and plotted on a logarithmic scale, gives a horizontal dispersion to the fields based on their relative biochemistry/physiology dependence. For most fields, the biochemistry/physiology coordinate is a stable indicator based on substantial data.

Each field has so far been located on the diagram by a point with specified vertical and horizontal coordinates. The point thus located is then surrounded by an ellipse with an area proportional to the size of the field. This shape provides another parameter for the description of an additional significant quantity for each field: the ratio of minor to major axis gives the percentage of self-citing. The field of dentistry, with 65% self-citing is closest to circular shape, while hematology, with only 25% self-citing is one of the more elongated.

2. Influence Maps for Individual Biomedical Fields

At the next level of detail, the journals themselves are used to construct individual field maps. The conventions followed for these maps are the same as those followed for the earlier individual field maps with one exception:

All arrows in the biomedical maps have full heads, so that there is no differentiation between first and second referenced journals through the size of the arrow head.

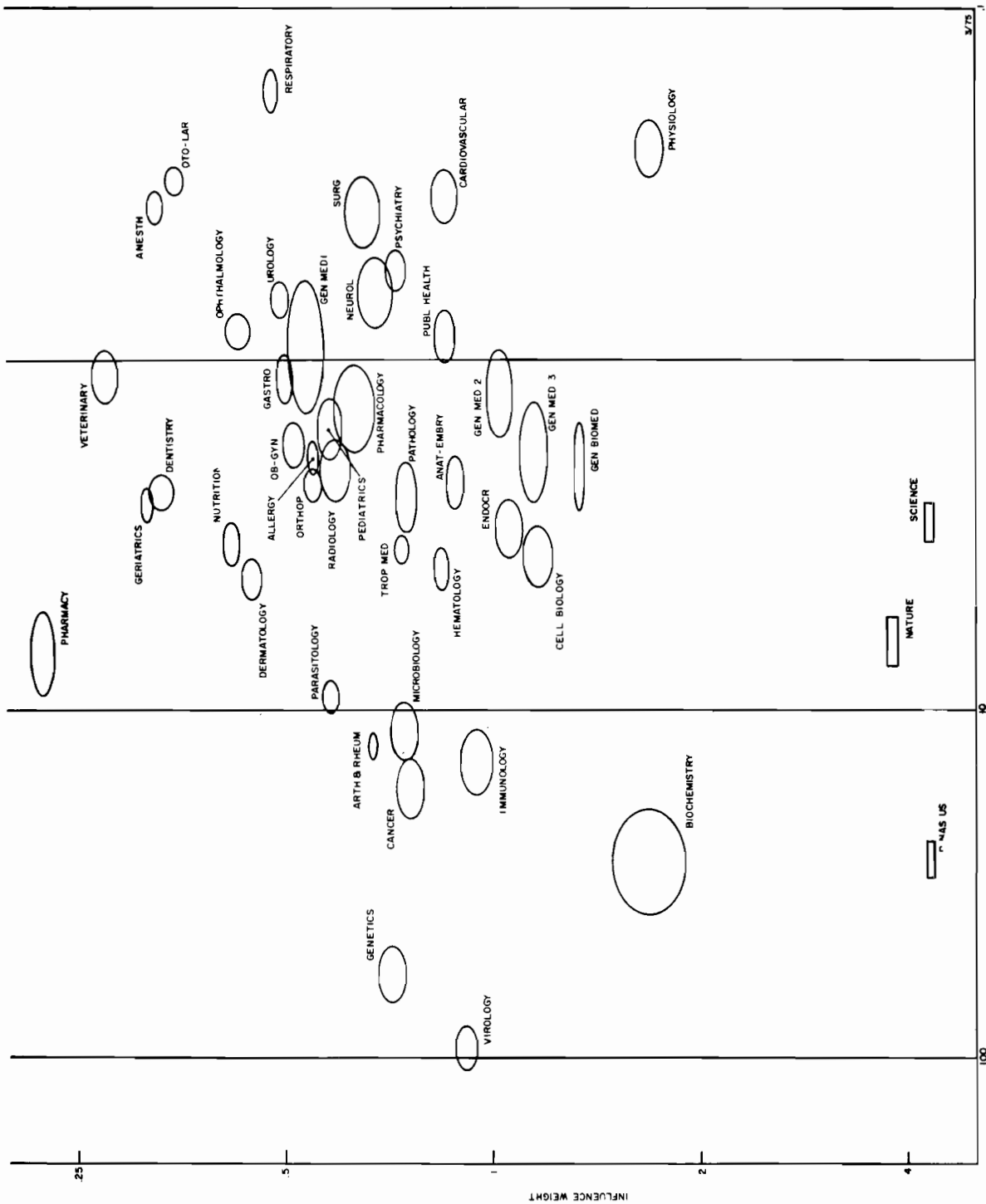

FIGURE 8-26

INFLUENCE STRUCTURE FOR THE BIOMEDICAL LITERATURE

The following maps are contained in this section.

INFLUENCE MAPS FOR BIOMEDICAL FIELDS

- Figure 8-27: Allergy and Immunology Journals
- Figure 8-28: Anesthesiology Journals
- Figure 8-29: Arthritis/Rheumatism Journals
- Figure 8-30: Cancer Journals
- Figure 8-31: Cardiovascular System Journals
- Figure 8-32: Dentistry Journals
- Figure 8-33: Dermatology/Venereal Diseases Journals
- Figure 8-34: Endocrinology Journals
- Figure 8-35: Genetics Journals
- Figure 8-36: Geriatrics/Gerontology Journals
- Figure 8-37: Hematology Journals
- Figure 8-38: Obstetrics/Gynecology and Fertility Journals
- Figure 8-39: Otorhinolaryngology and Ophthalmology Journals
- Figure 8-40: Pathology Journals
- Figure 8-41: Pediatrics Journals
- Figure 8-42: Radiology and Nuclear Medicine Journals
- Figure 8-43: Respiratory System Journals
- Figure 8-44: Veterinary Journals
- Figure 8-45: Biochemistry/Molecular Biology/Biophysics/
Physiology Journals
- Figure 8-46: Cell Biology/Anatomy/Embryology/
Microscopy Journals
- Figure 8-47: Environmental and Public Health/
Tropical Medicine and Parasitology
Journals
- Figure 8-48: Gastroenterology Journals
- Figure 8-49: General and Internal Medicine/Clinical
Science Journals
- Figure 8-50: Neurological System Journals
- Figure 8-51: Nutrition and Dietetics Journals
- Figure 8-52: Orthopedics/Surgery/Urology Journals
- Figure 8-53: Pharmacology and Pharmacy Journals
- Figure 8-54: Psychiatry Journals
- Figure 8-55: Virology and Microbiology Journals

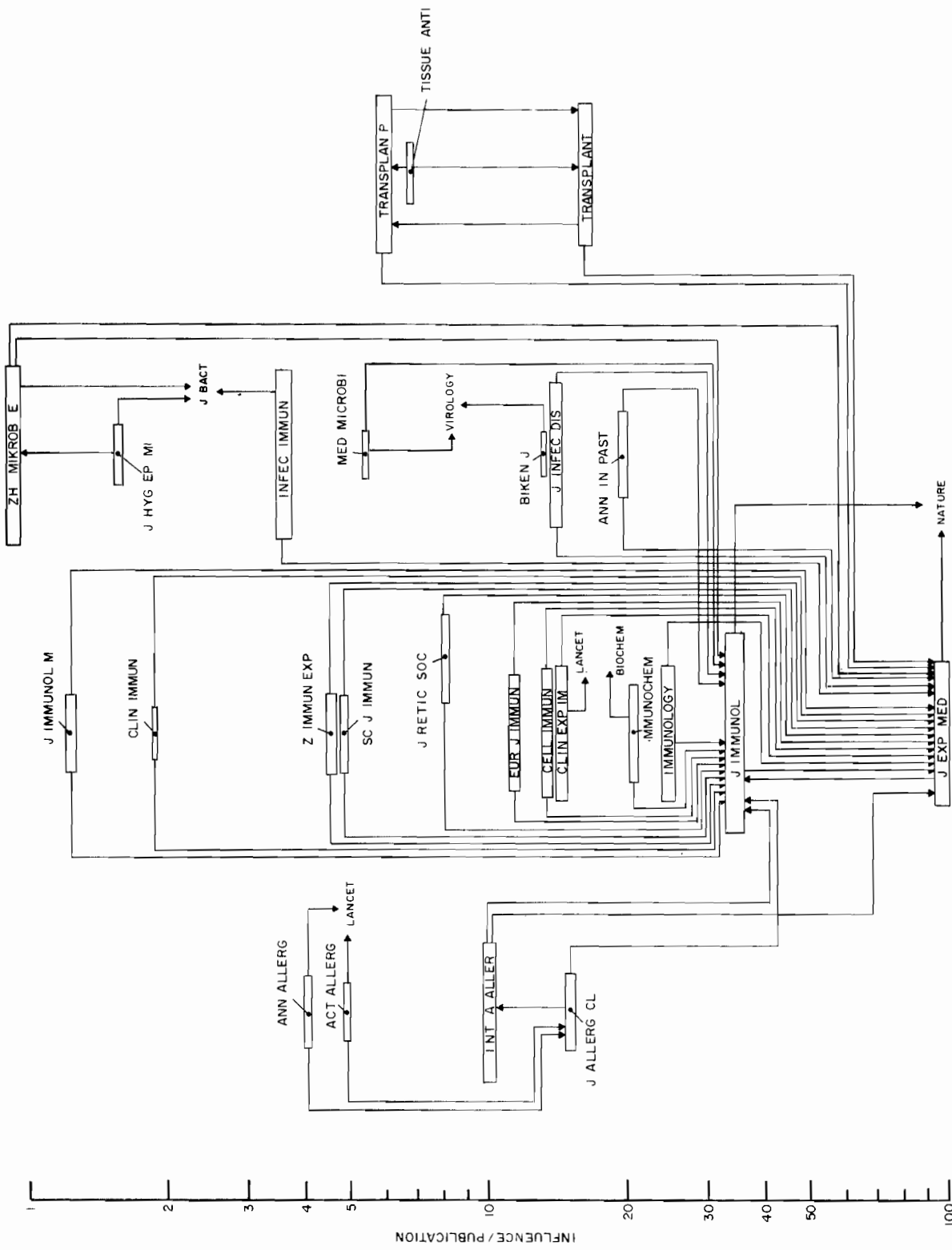

FIGURE 8-27

INFLUENCE MAP FOR ALLERGY AND IMMUNOLOGY JOURNALS

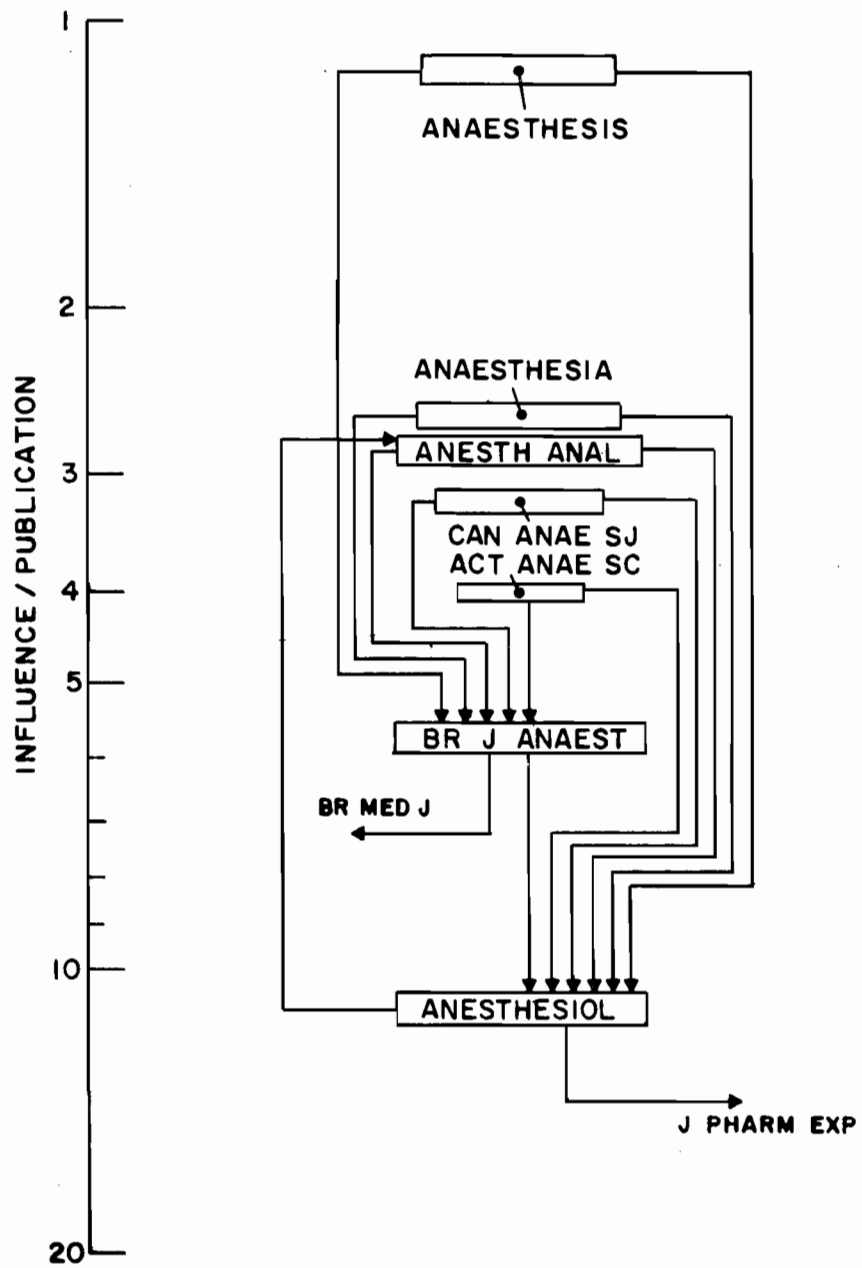

FIGURE 8-28

INFLUENCE MAP FOR ANESTHESIOLOGY JOURNALS

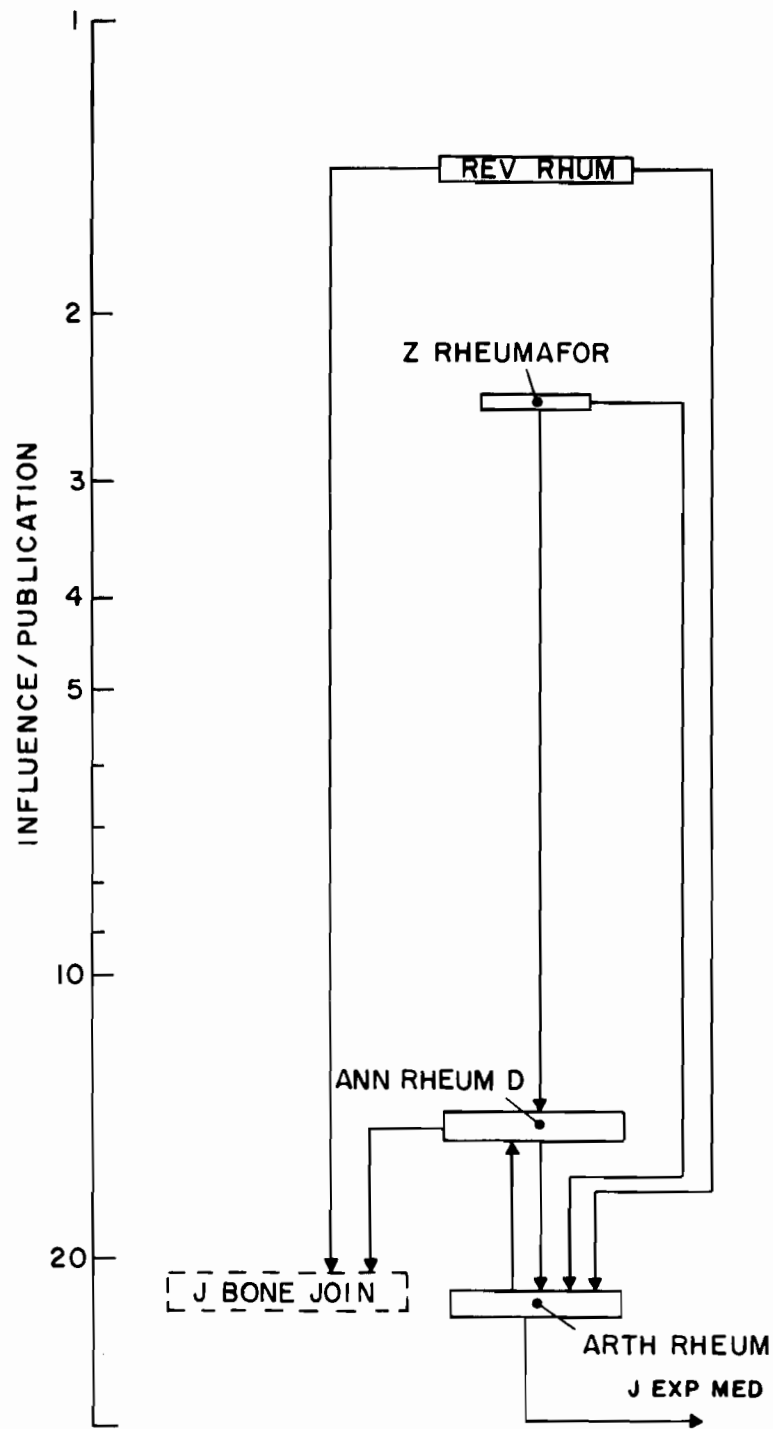

FIGURE 8-29

INFLUENCE MAP FOR ARTHRITIS/RHEUMATISM JOURNALS

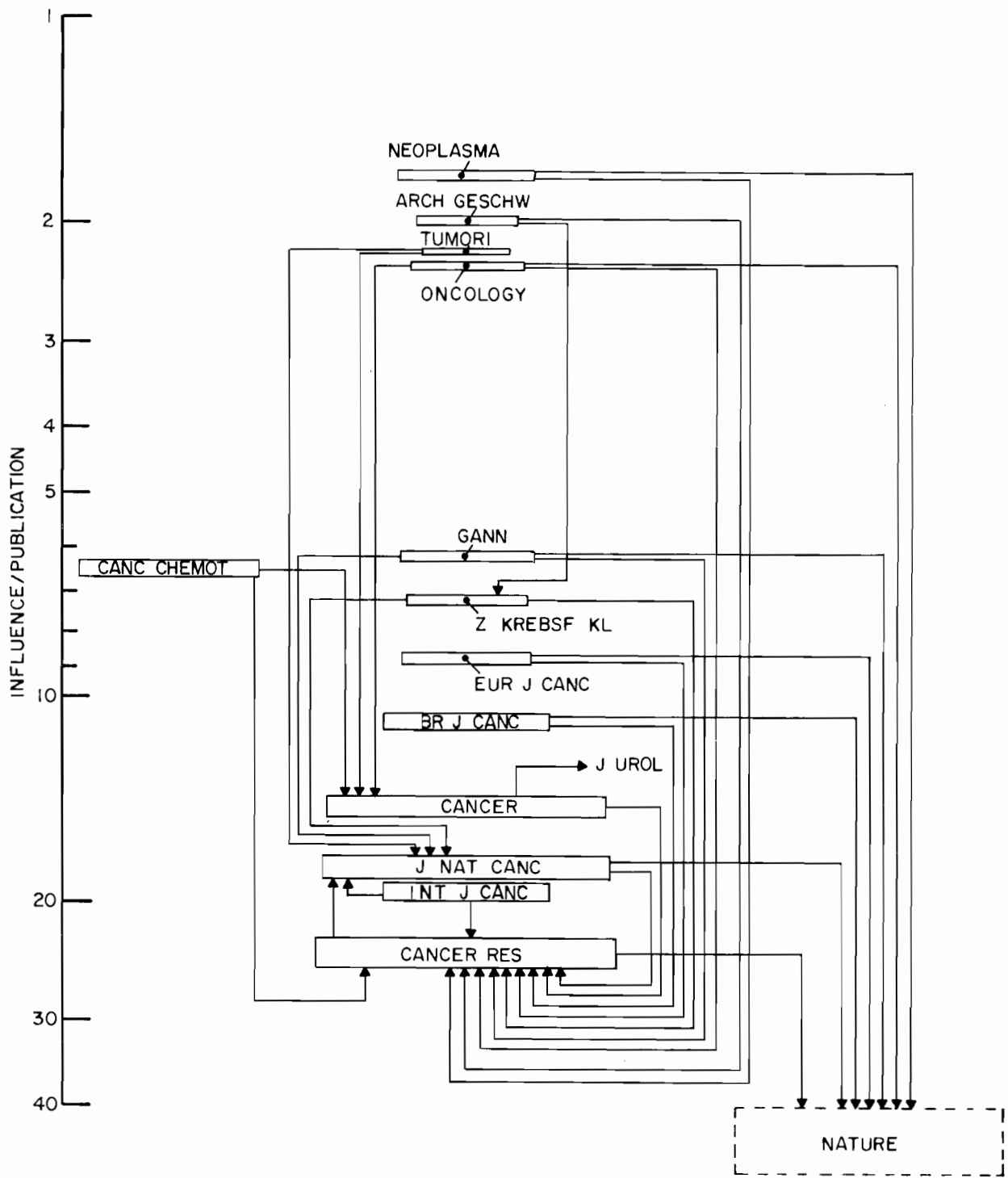

FIGURE 8-30

INFLUENCE MAP FOR CANCER JOURNALS

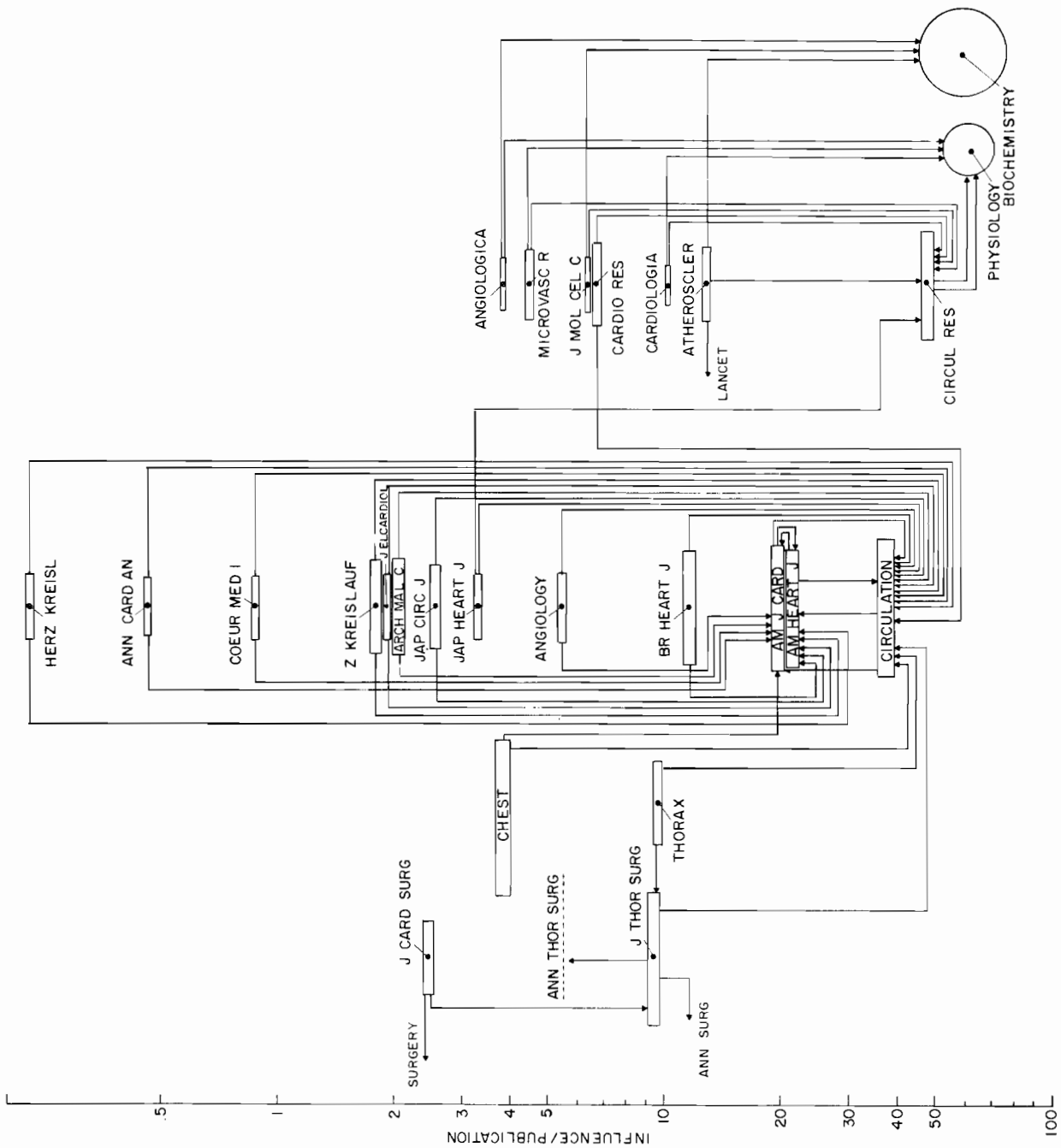

FIGURE 8-31

INFLUENCE MAP FOR CARDIOVASCULAR SYSTEM JOURNALS

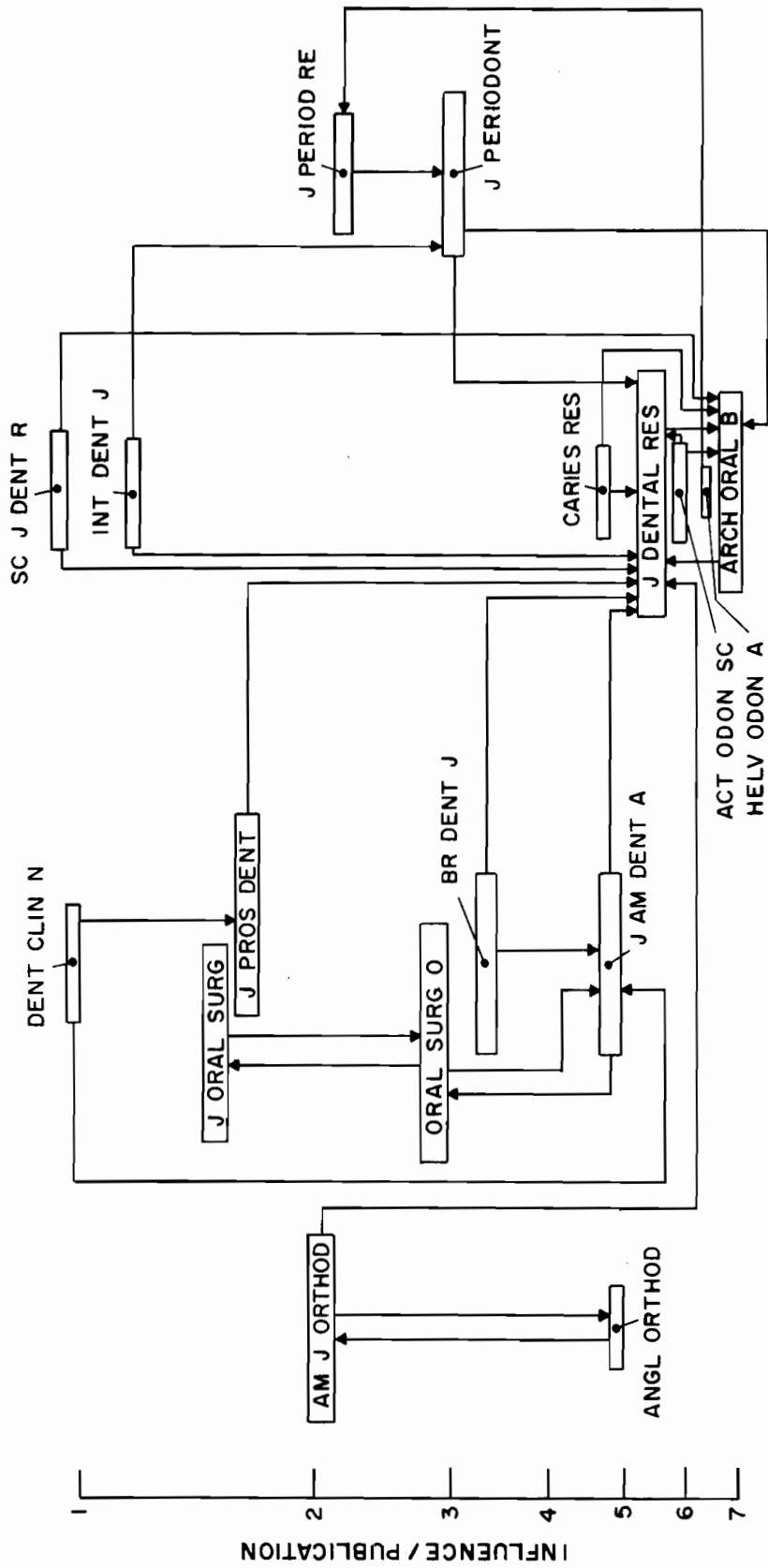

FIGURE 8-32
INFLUENCE MAP FOR DENTISTRY JOURNALS

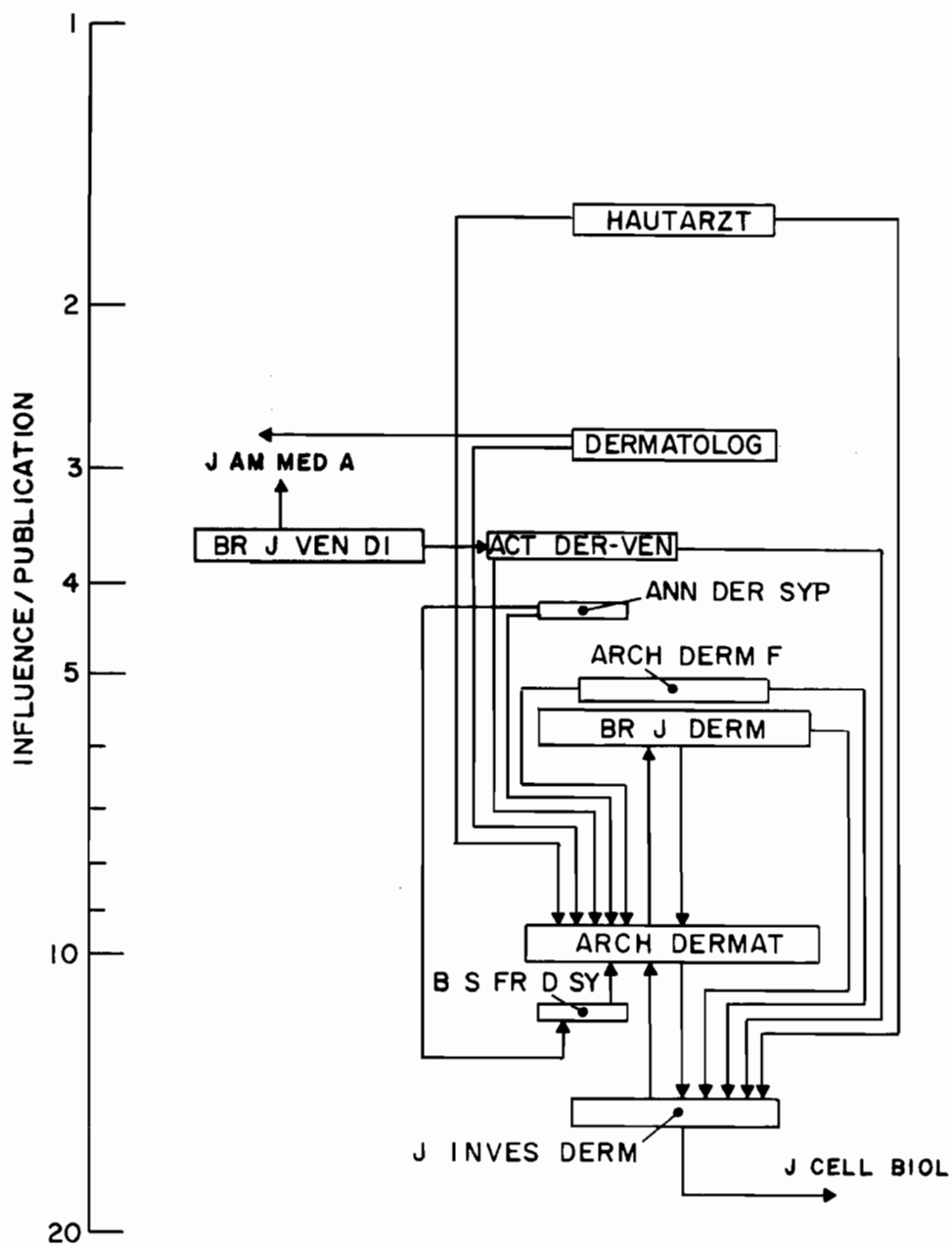

FIGURE 8-33

INFLUENCE MAP FOR DERMATOLOGY/VENEREAL DISEASES JOURNALS

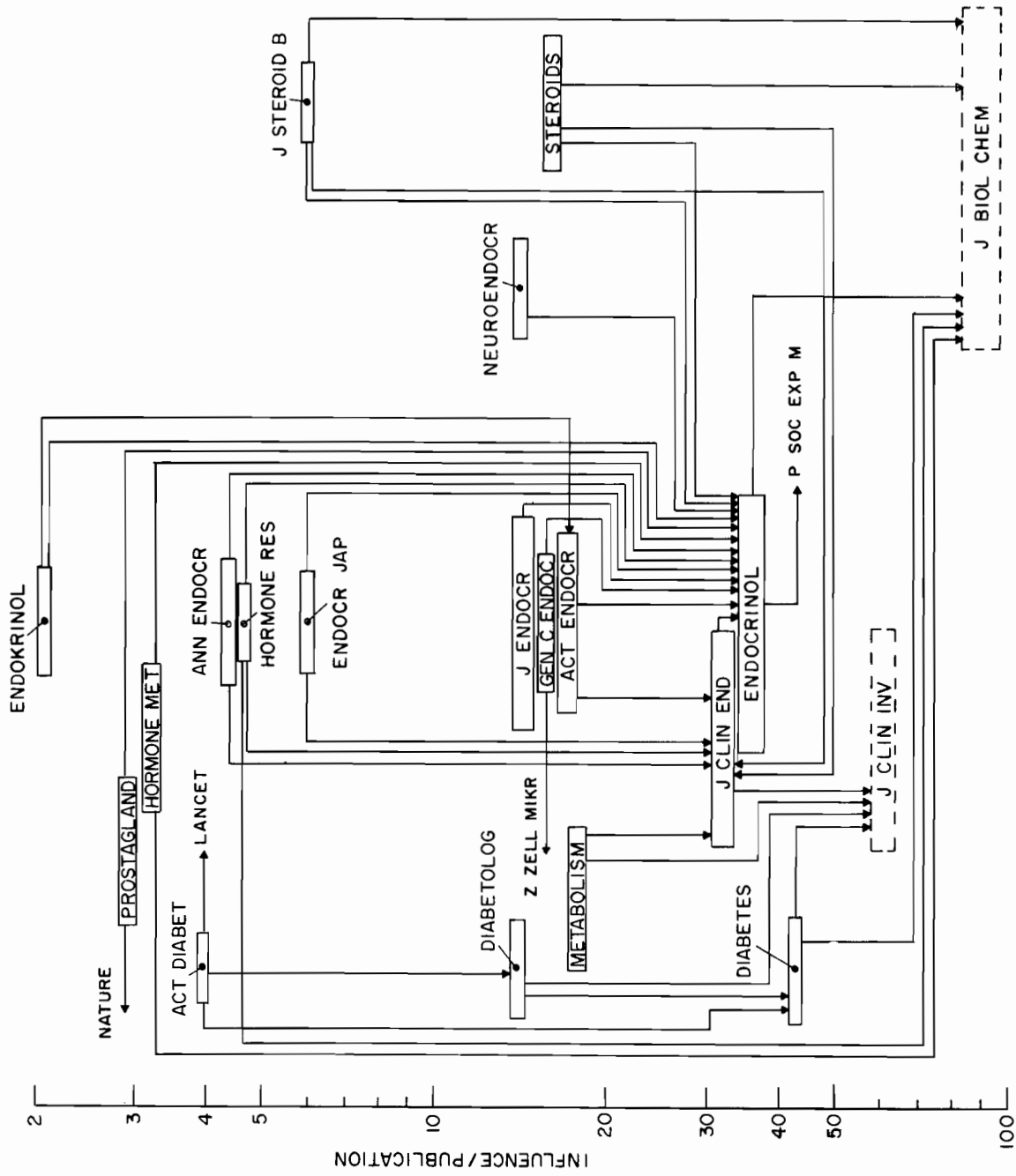

FIGURE 8-34

INFLUENCE MAP FOR ENDOCRINOLOGY JOURNALS

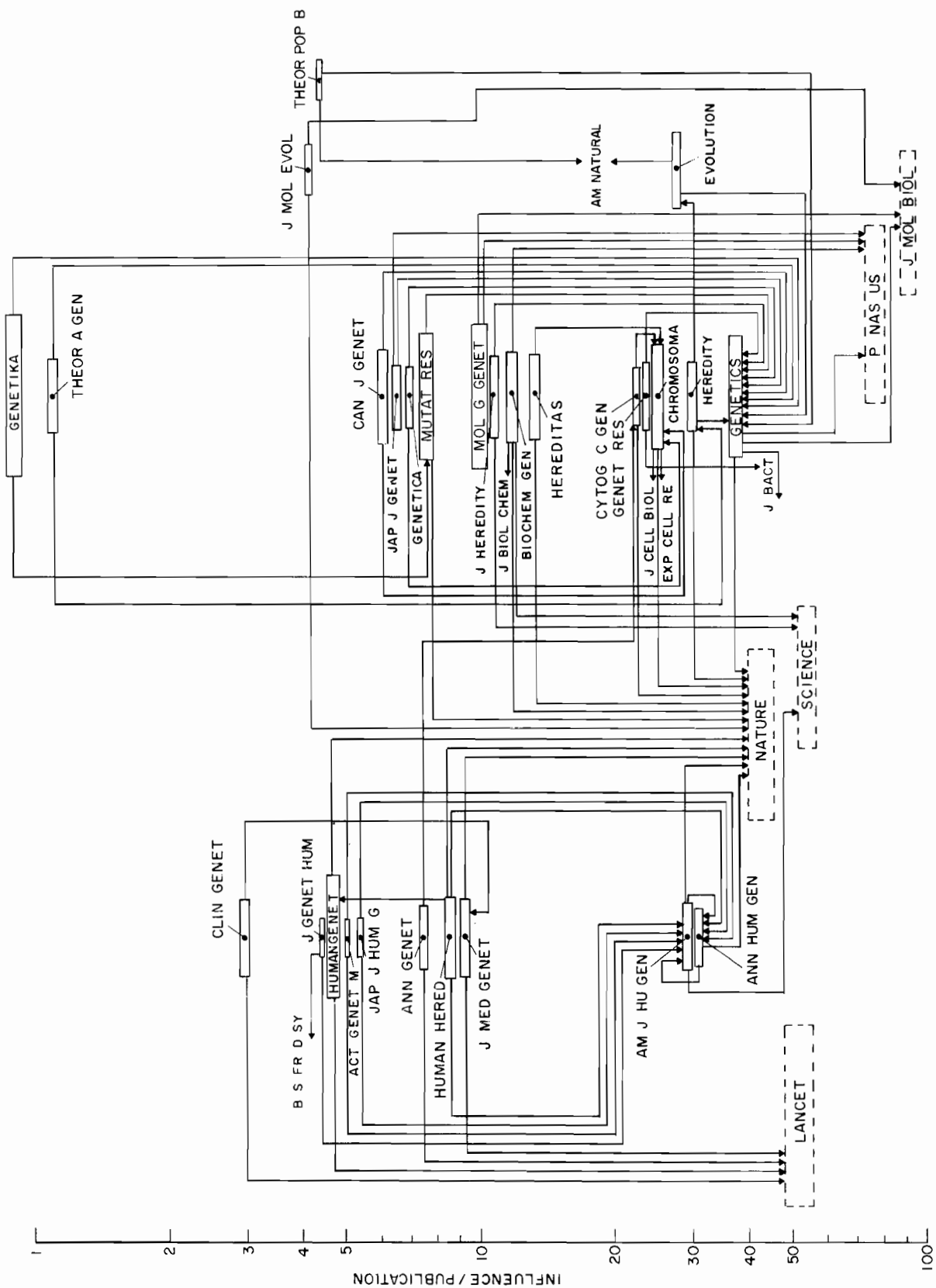

FIGURE 8-35

INFLUENCE MAP FOR GENETICS JOURNALS

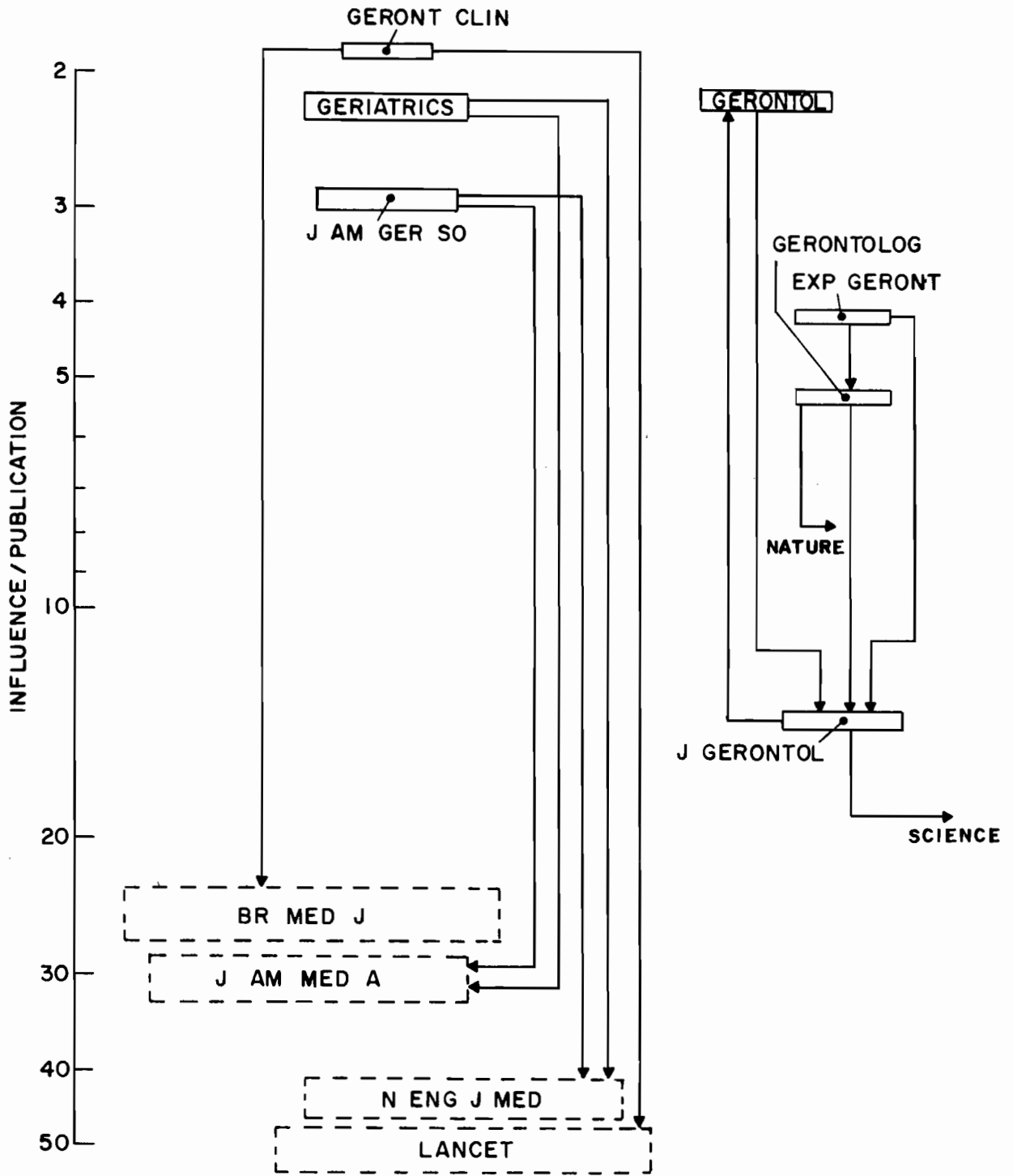

FIGURE 8-36

INFLUENCE MAP FOR GERIATRICS/GERONTOLOGY JOURNALS

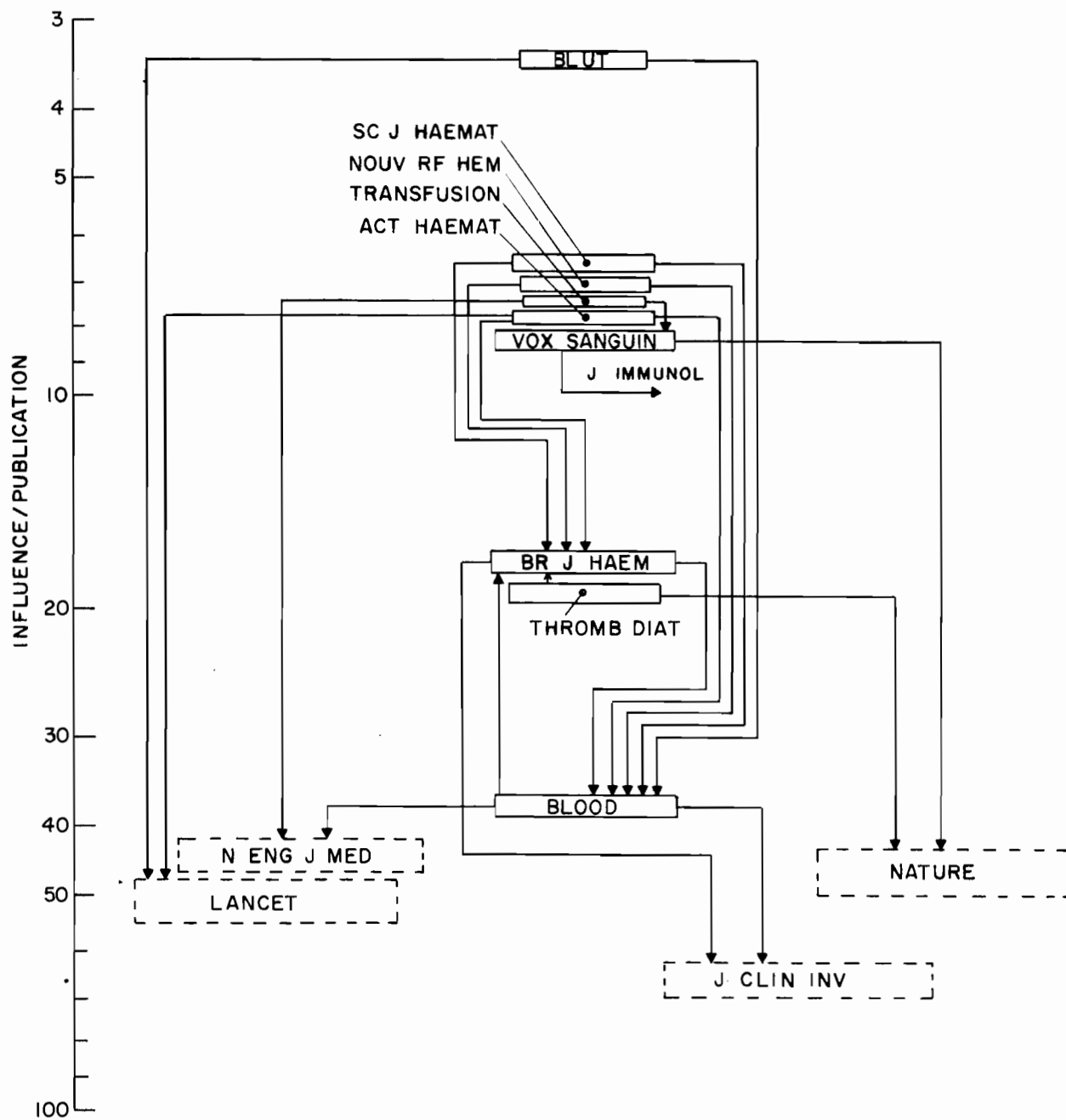

FIGURE 8-37

INFLUENCE MAP FOR HEMATOLOGY JOURNALS

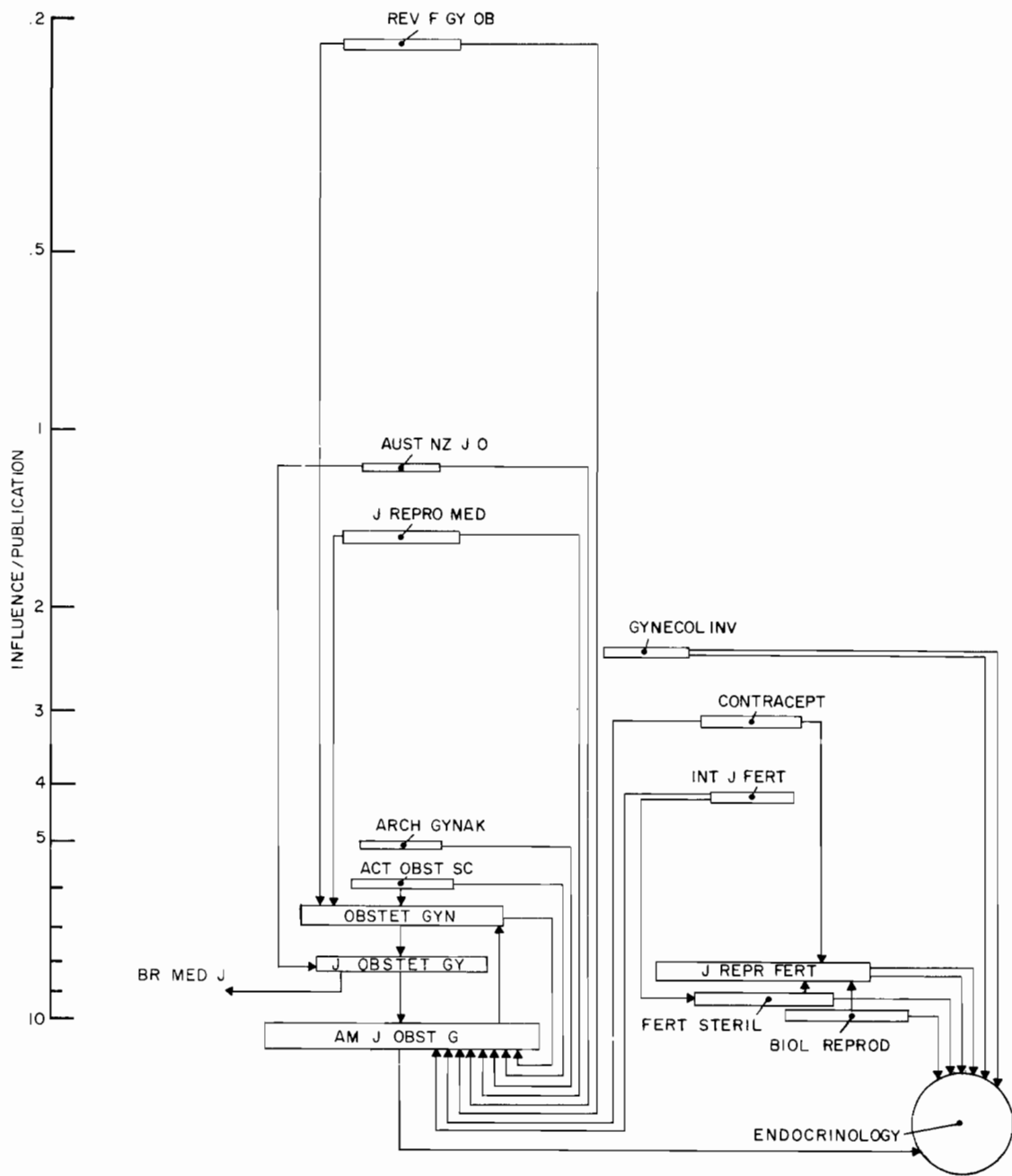

FIGURE 8-38

INFLUENCE MAP FOR OBSTETRICS/GYNECOLOGY AND FERTILITY JOURNALS

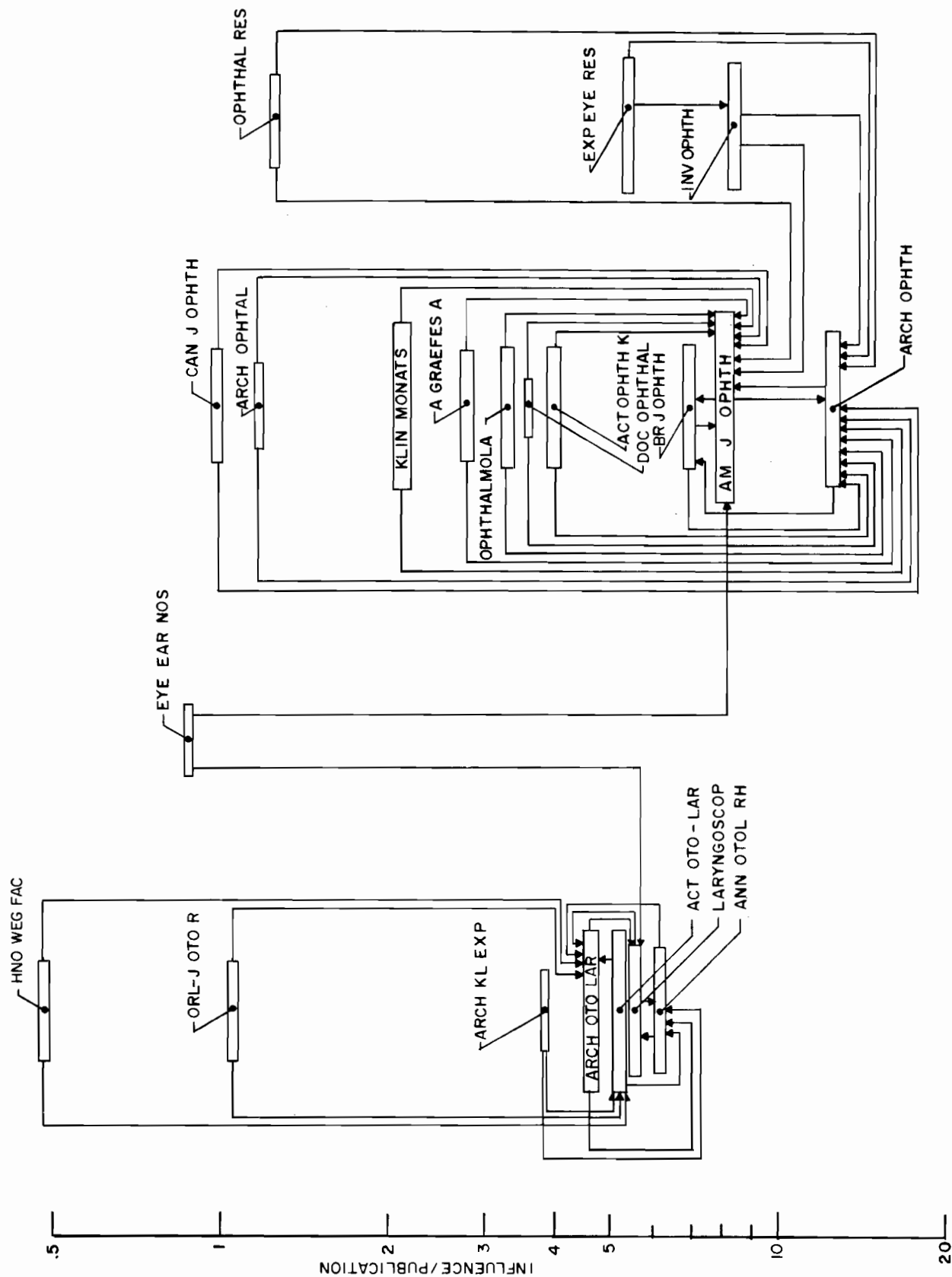

FIGURE 8-39

INFLUENCE MAP FOR OTORHINOLARYNGOLOGY AND OPHTHALMOLOGY JOURNALS

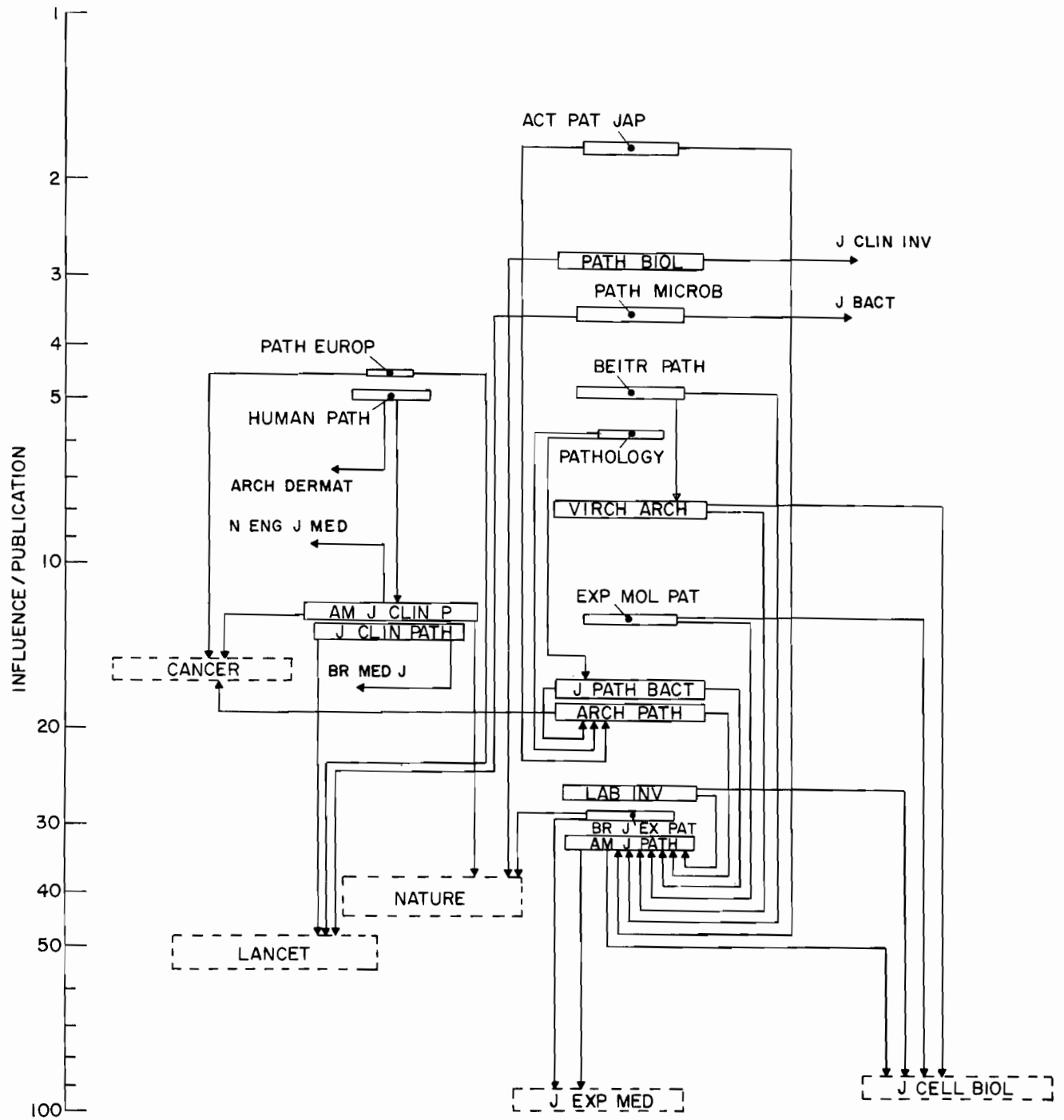

FIGURE 8-40

INFLUENCE MAP FOR PATHOLOGY JOURNALS

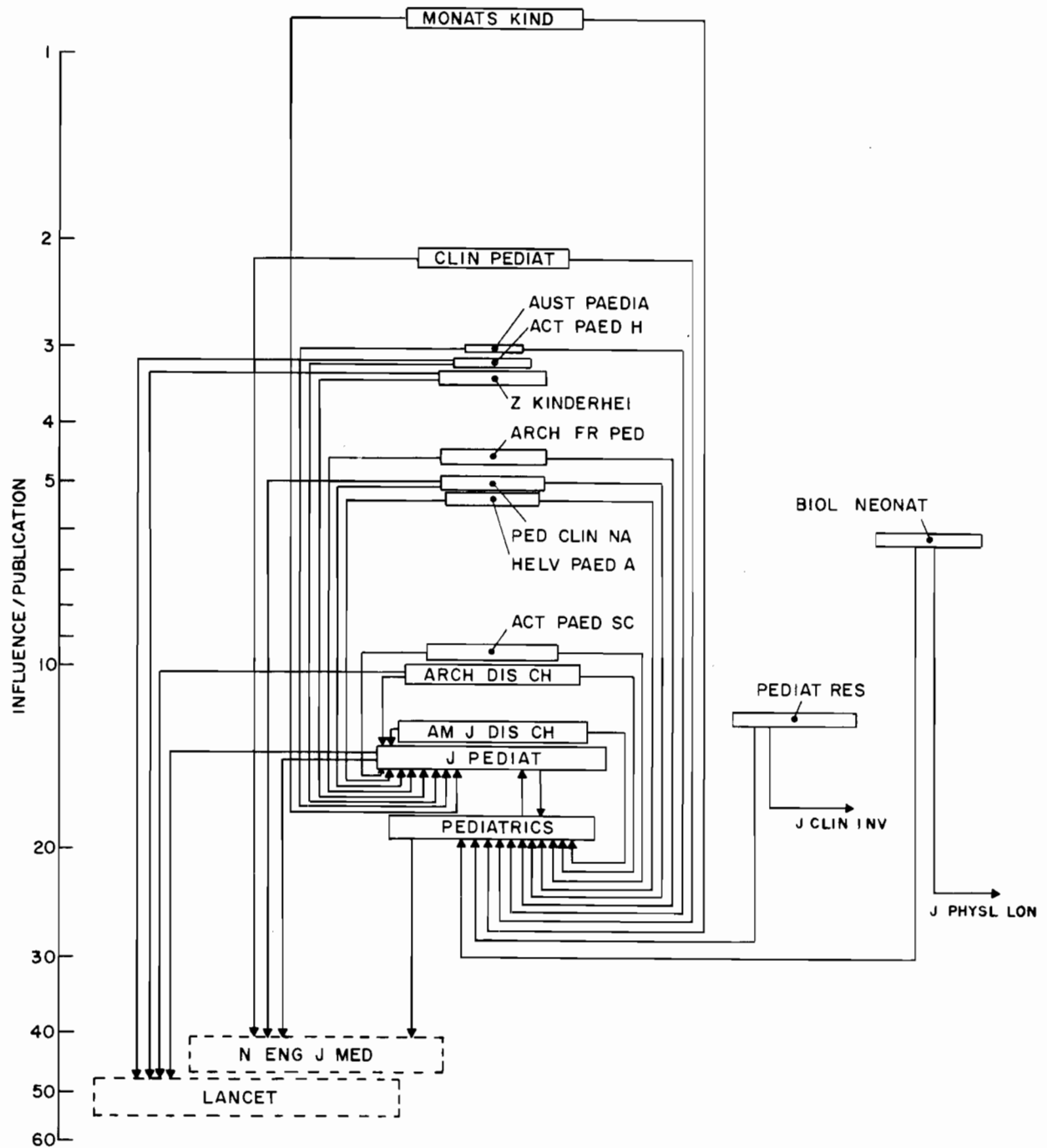

FIGURE 8-41

INFLUENCE MAP FOR PEDIATRICS JOURNALS

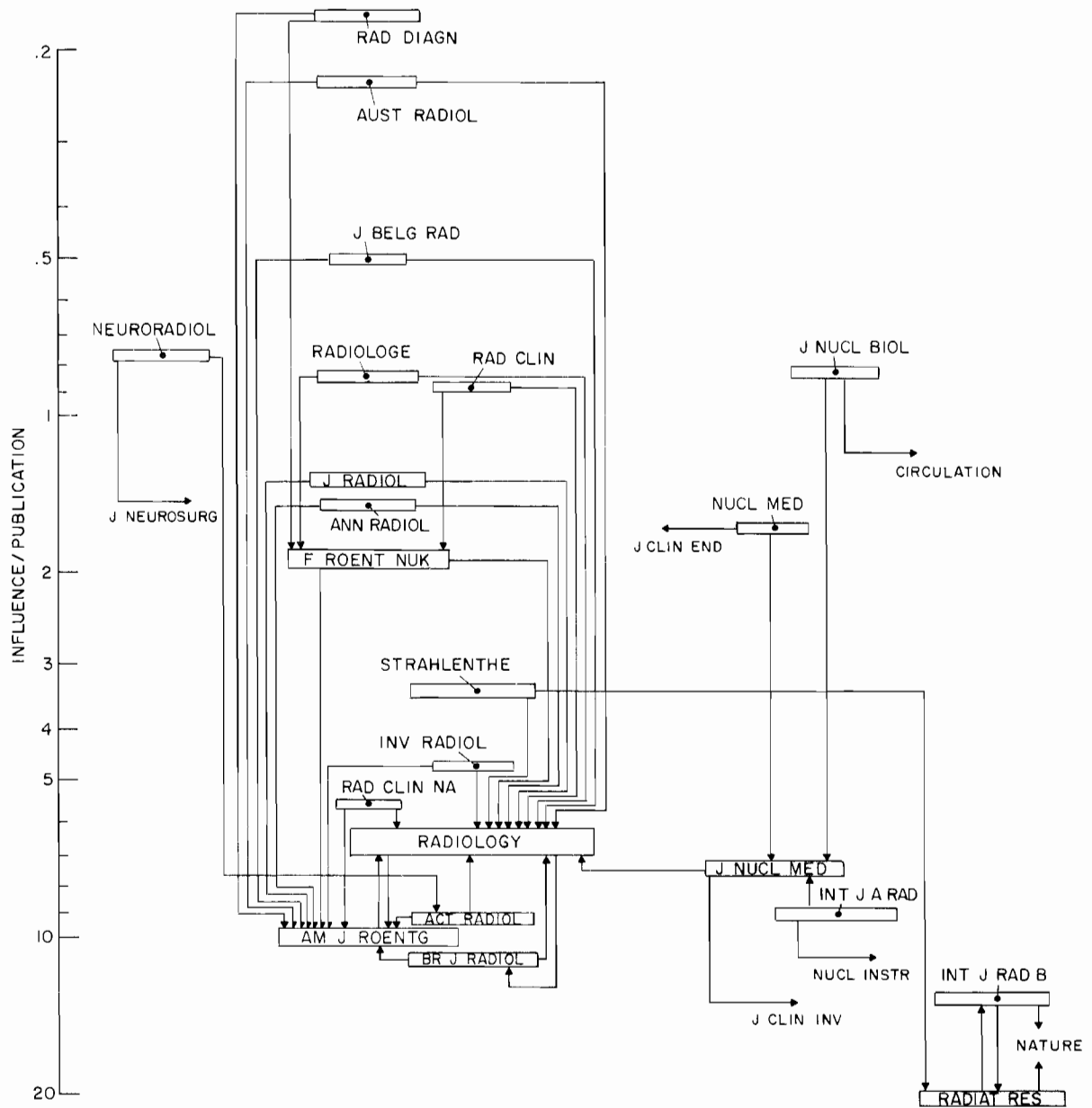

FIGURE 8-42

INFLUENCE MAP FOR RADIOLOGY AND NUCLEAR MEDICINE JOURNALS

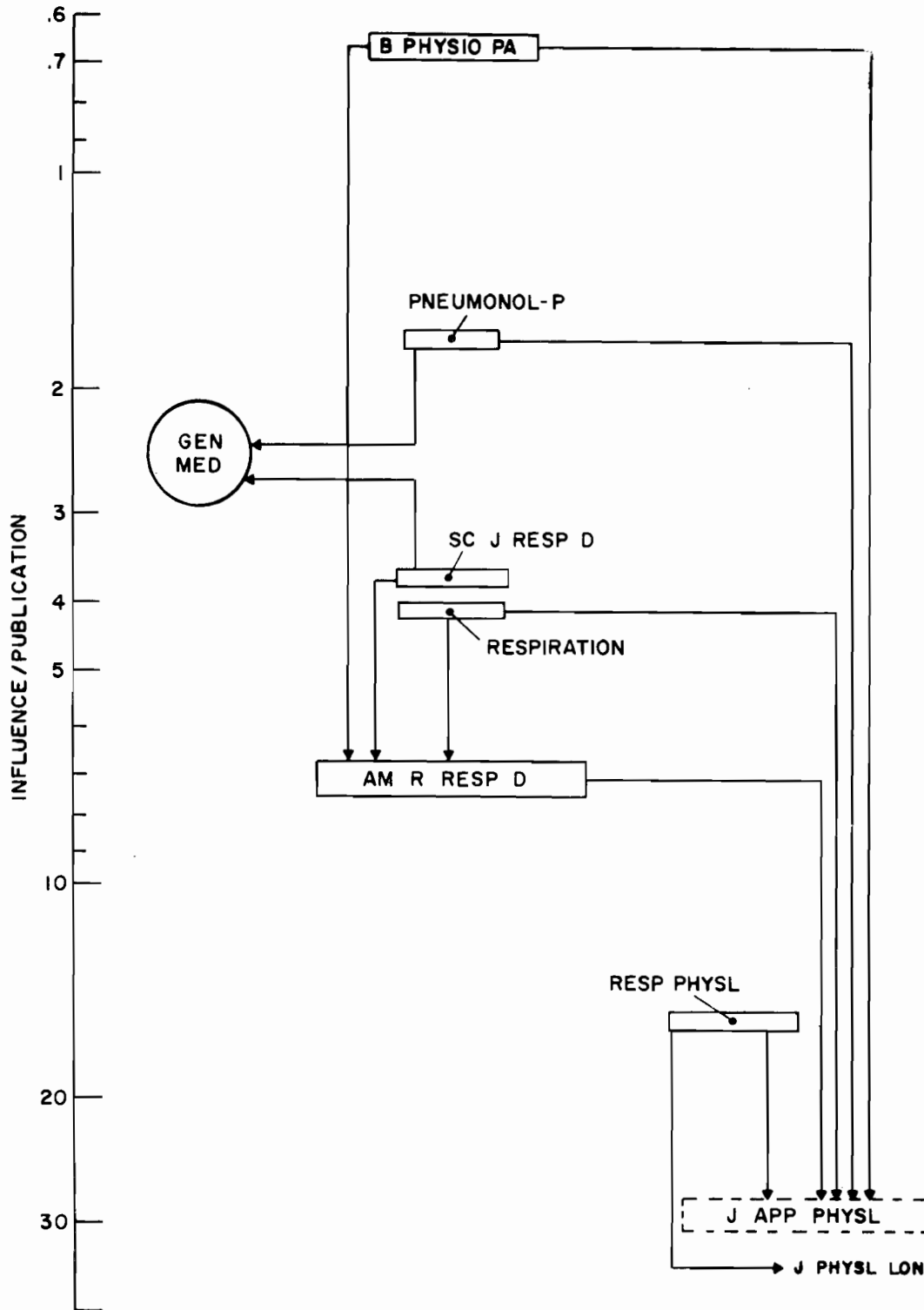

FIGURE 8-43

INFLUENCE MAP FOR RESPIRATORY SYSTEM JOURNALS

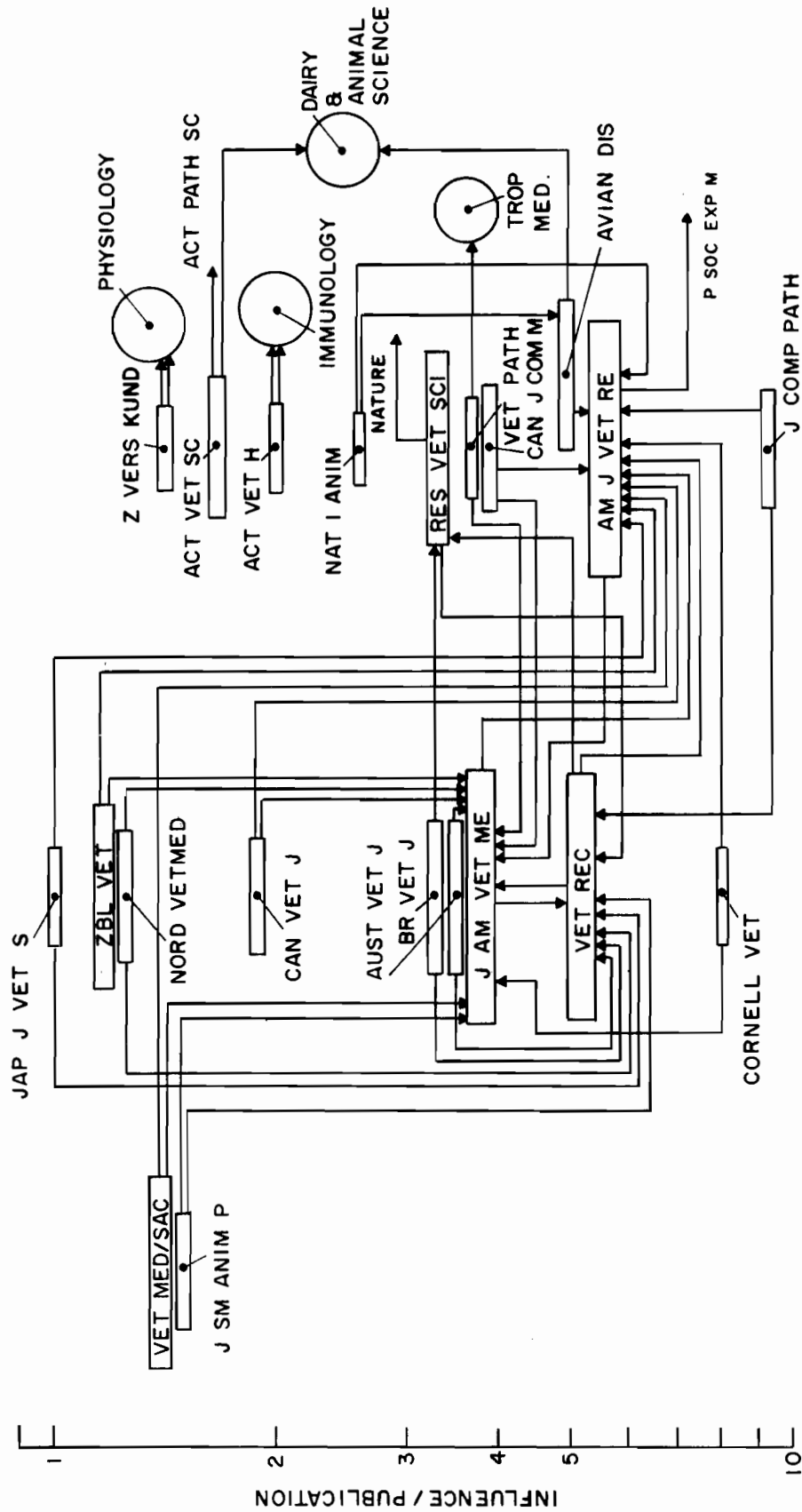

FIGURE 8-44
INFLUENCE MAP FOR VETERINARY JOURNALS

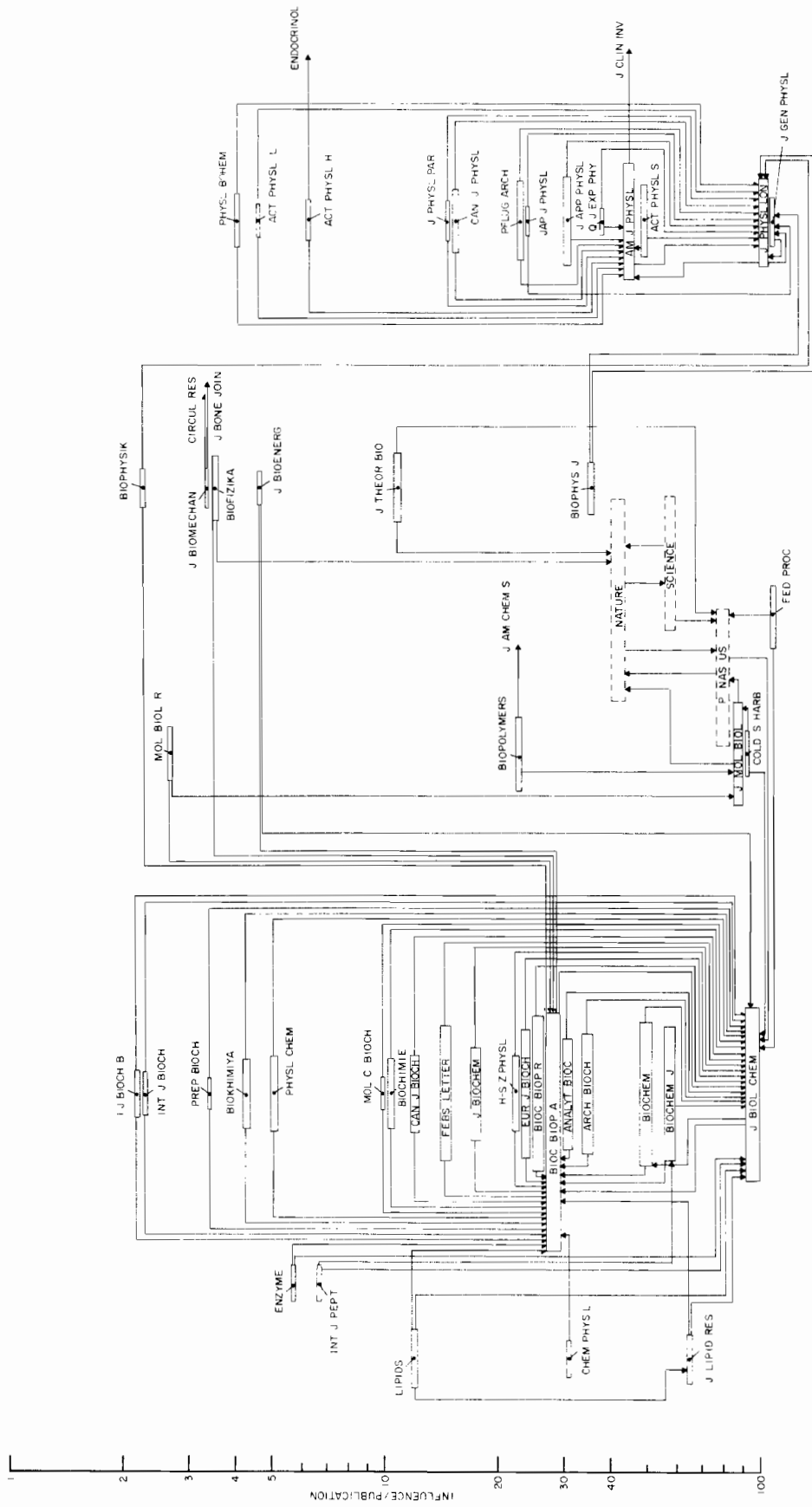

FIGURE 8-45
 INFLUENCE MAP FOR BIOCHEMISTRY/MOLECULAR
 BIOLOGY/BIOPHYSICS/PHYSIOLOGY JOURNALS

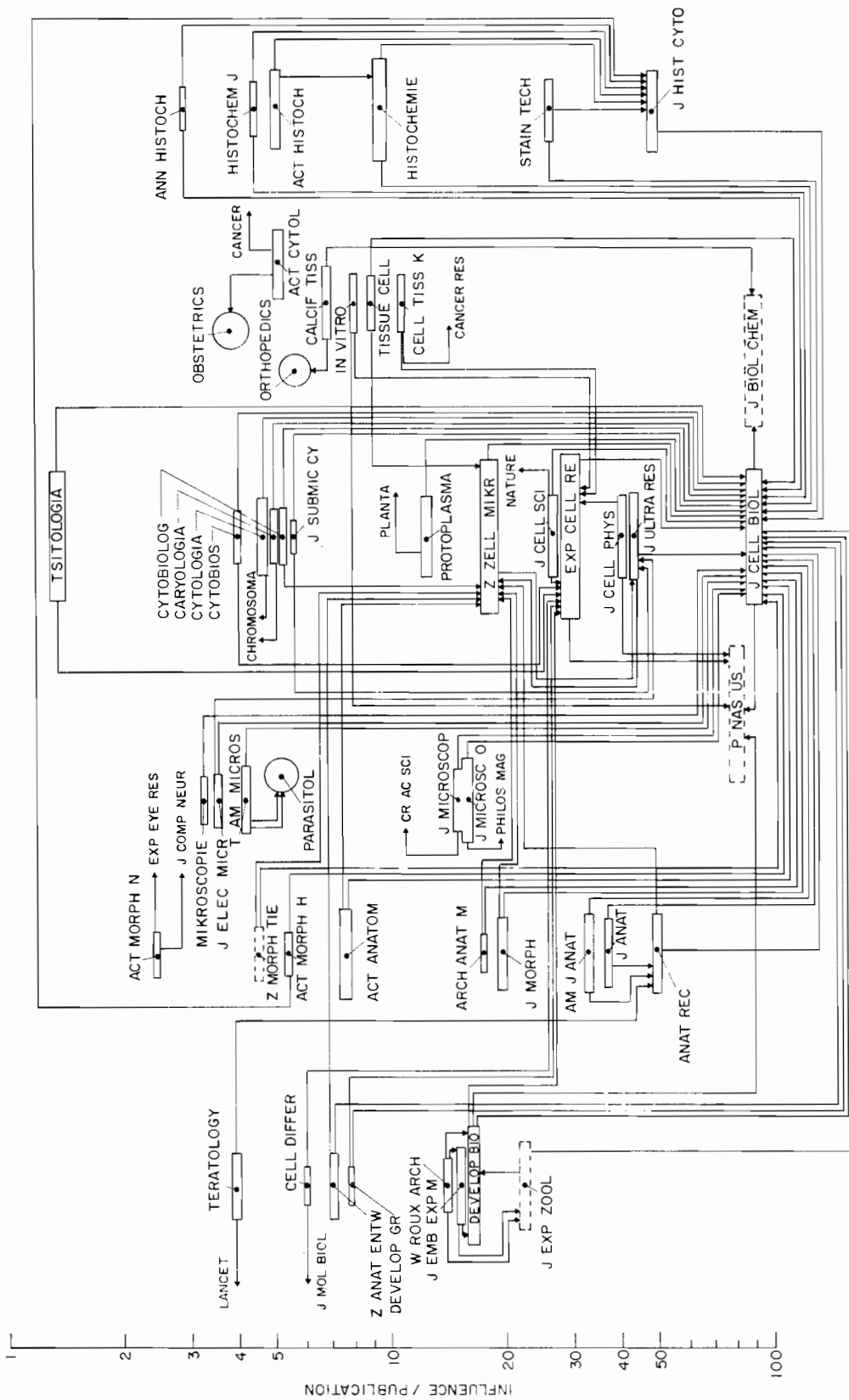

FIGURE 8-46

INFLUENCE MAP FOR CELL BIOLOGY/ANATOMY/EMBRYOLOGY/MICROSCOPY/JOURNALS

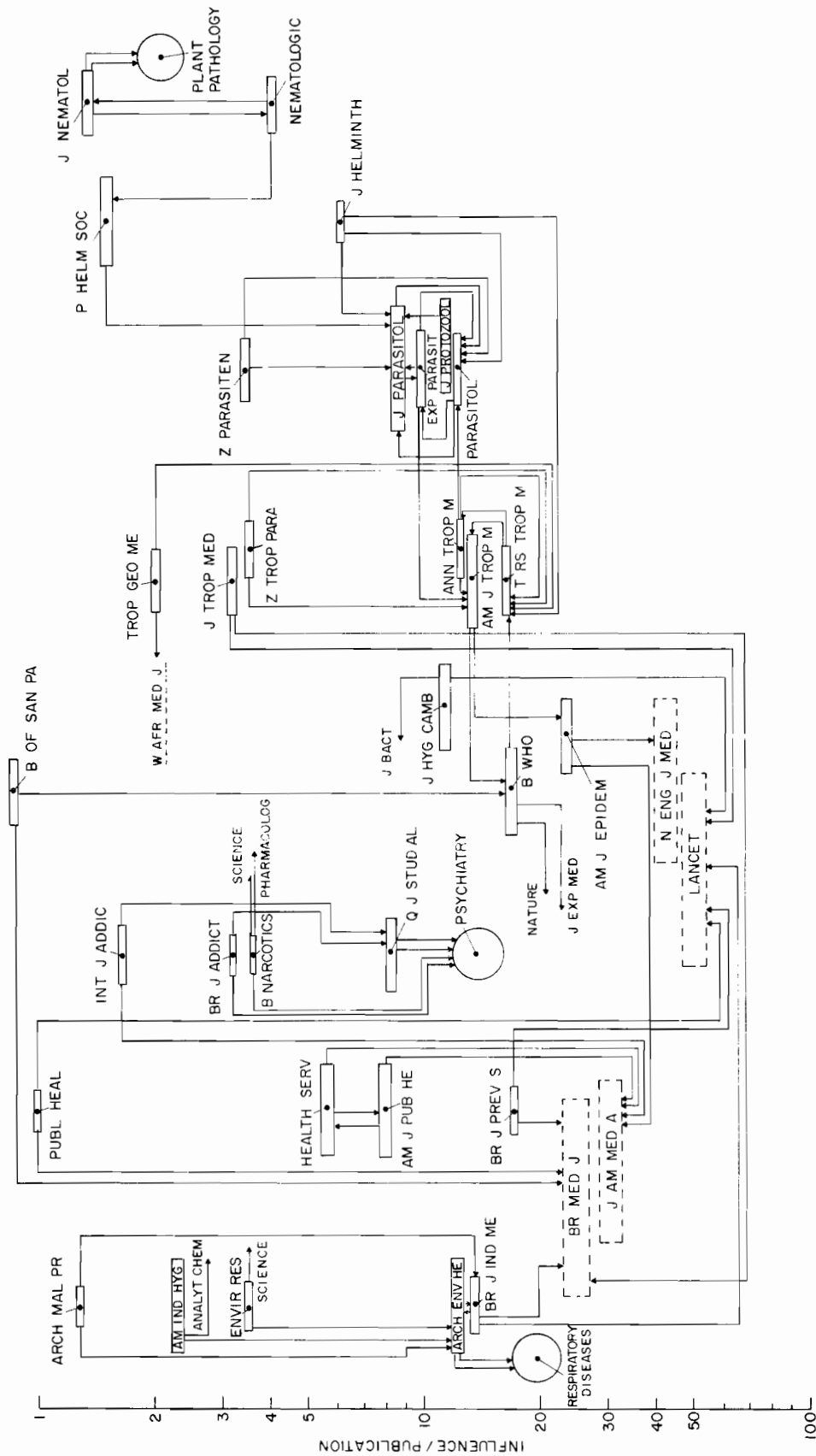

FIGURE 8-47

INFLUENCE MAP FOR ENVIRONMENTAL AND PUBLIC HEALTH/
TROPICAL MEDICINE AND PARASITOLOGY JOURNALS

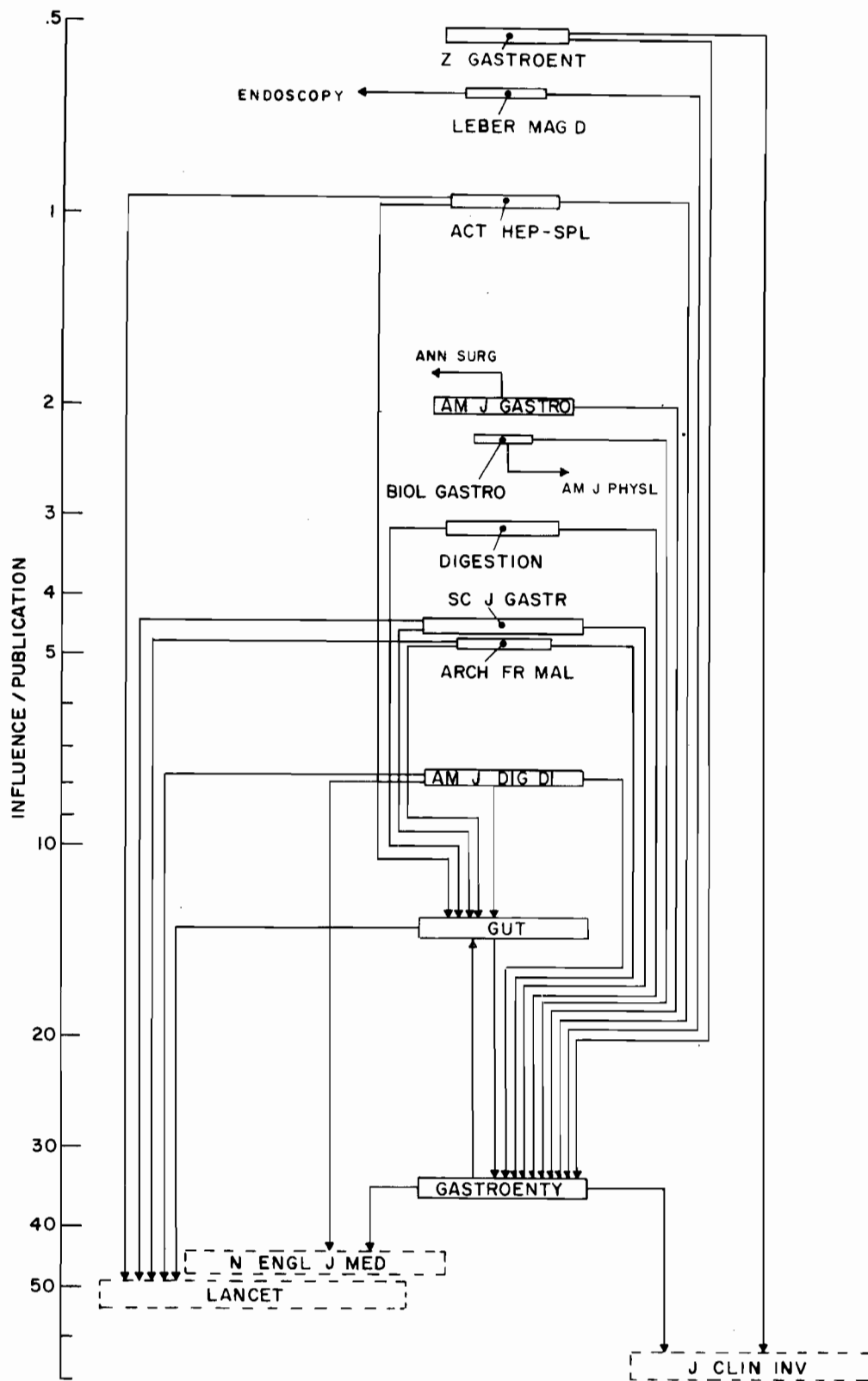

FIGURE 8-48

INFLUENCE MAP FOR GASTROENTEROLOGY JOURNALS

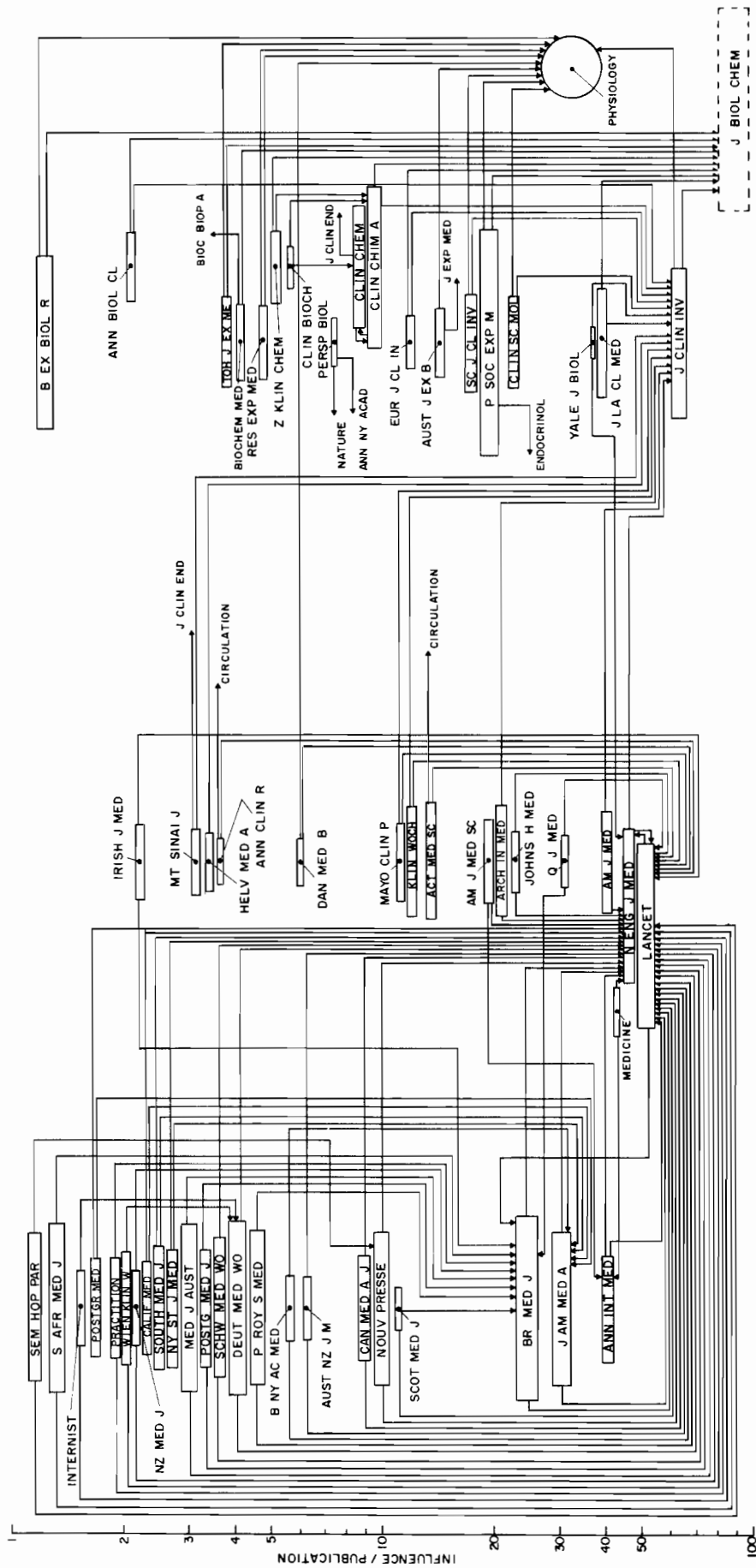

FIGURE 8-49

INFLUENCE MAP FOR GENERAL AND INTERNAL MEDICINE/CLINICAL
SCIENCE JOURNALS

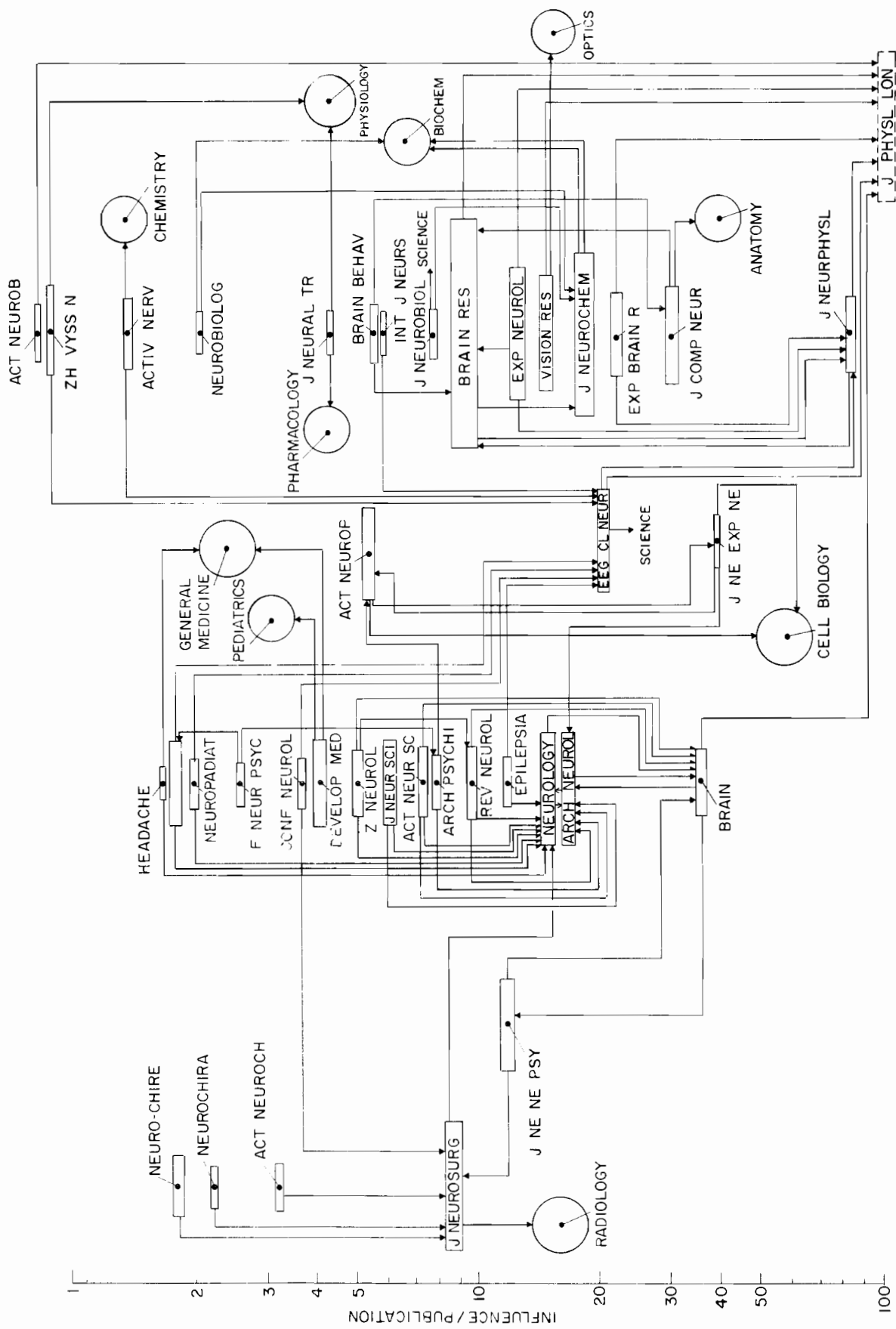

FIGURE 8-50

INFLUENCE MAP FOR NEUROLOGICAL SYSTEM JOURNALS

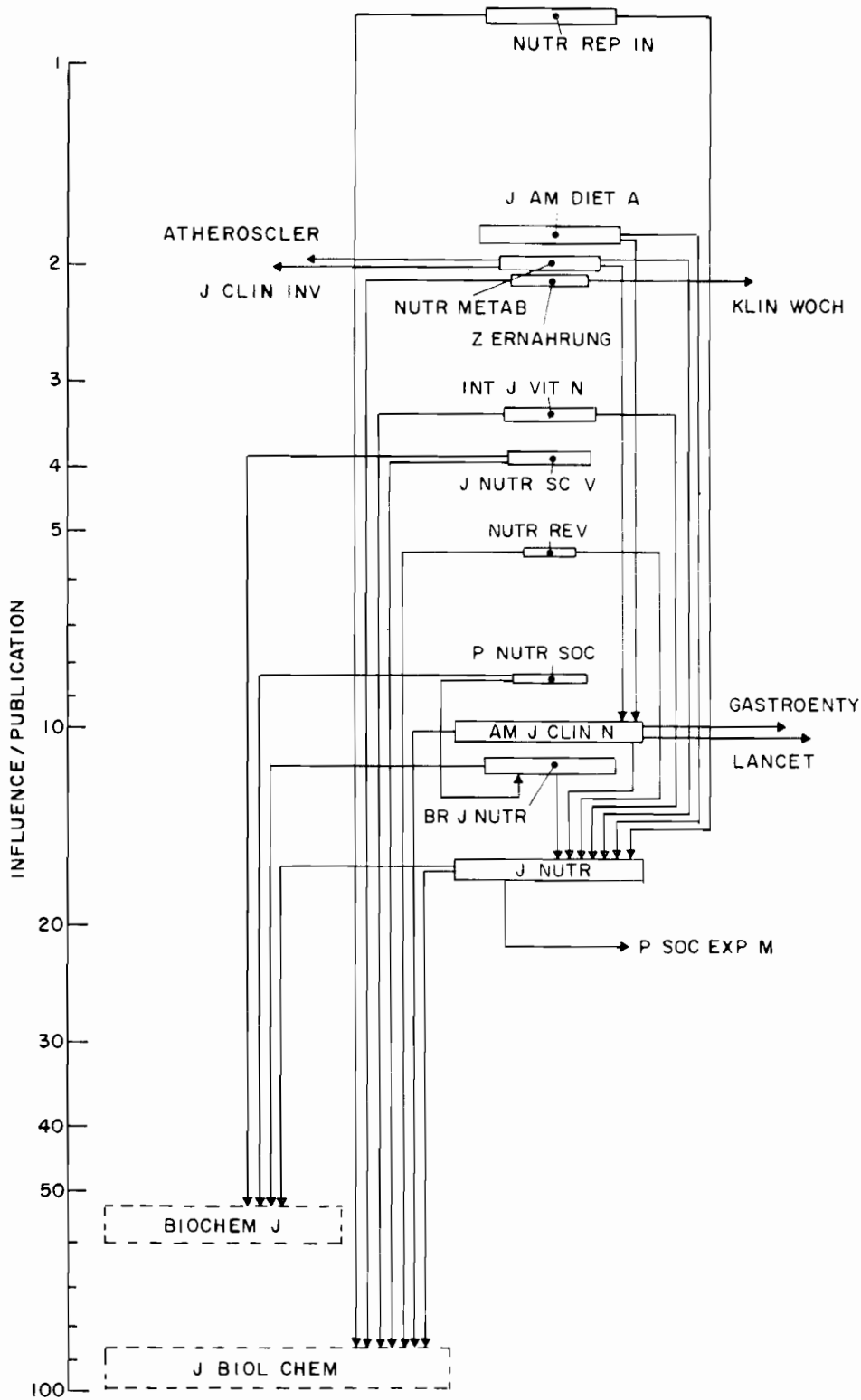

FIGURE 8-51

INFLUENCE MAP FOR NUTRITION AND DIETETICS JOURNALS

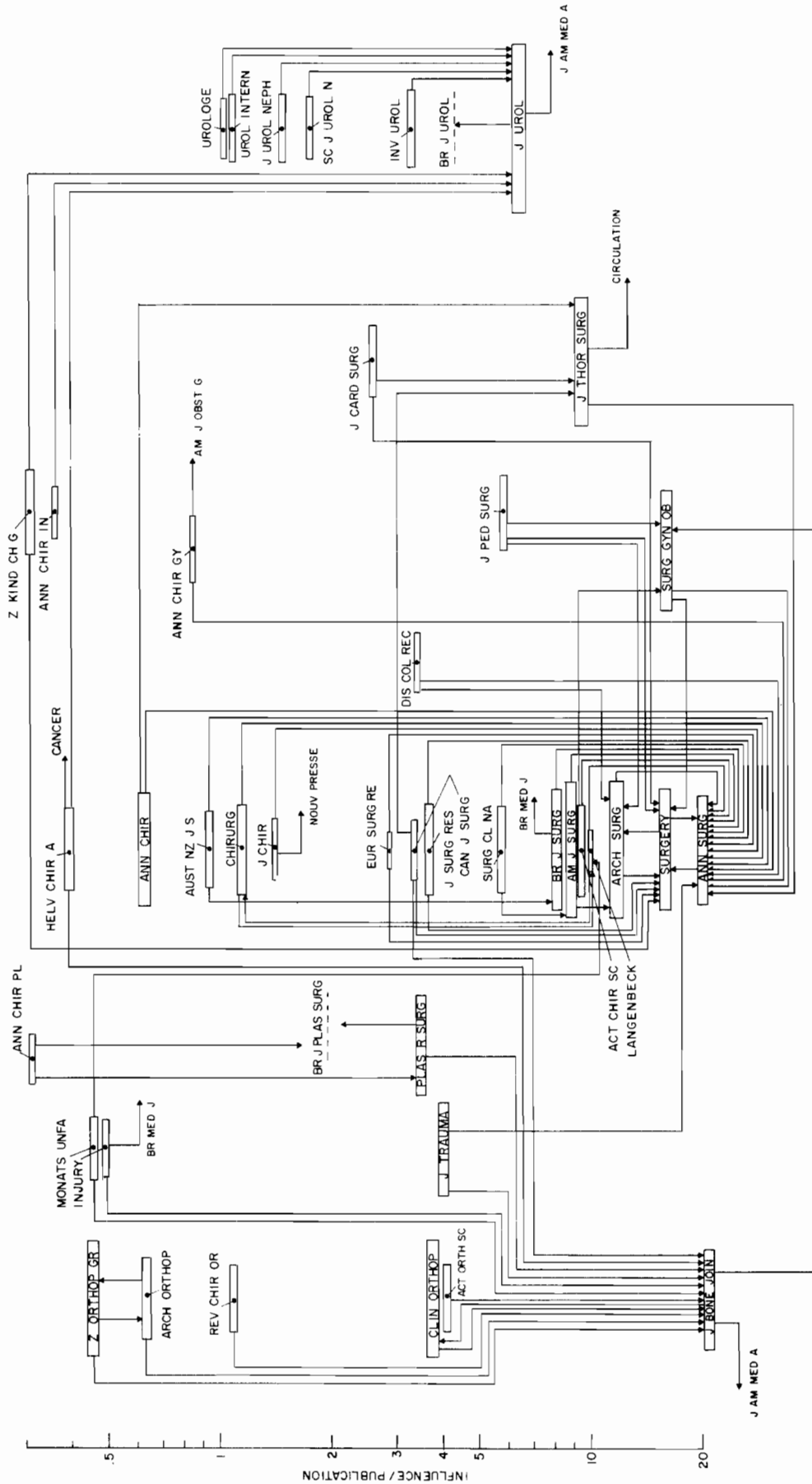

FIGURE 8-52

INFLUENCE MAP FOR ORTHOPEDICS/SURGERY/UROLOGY JOURNALS

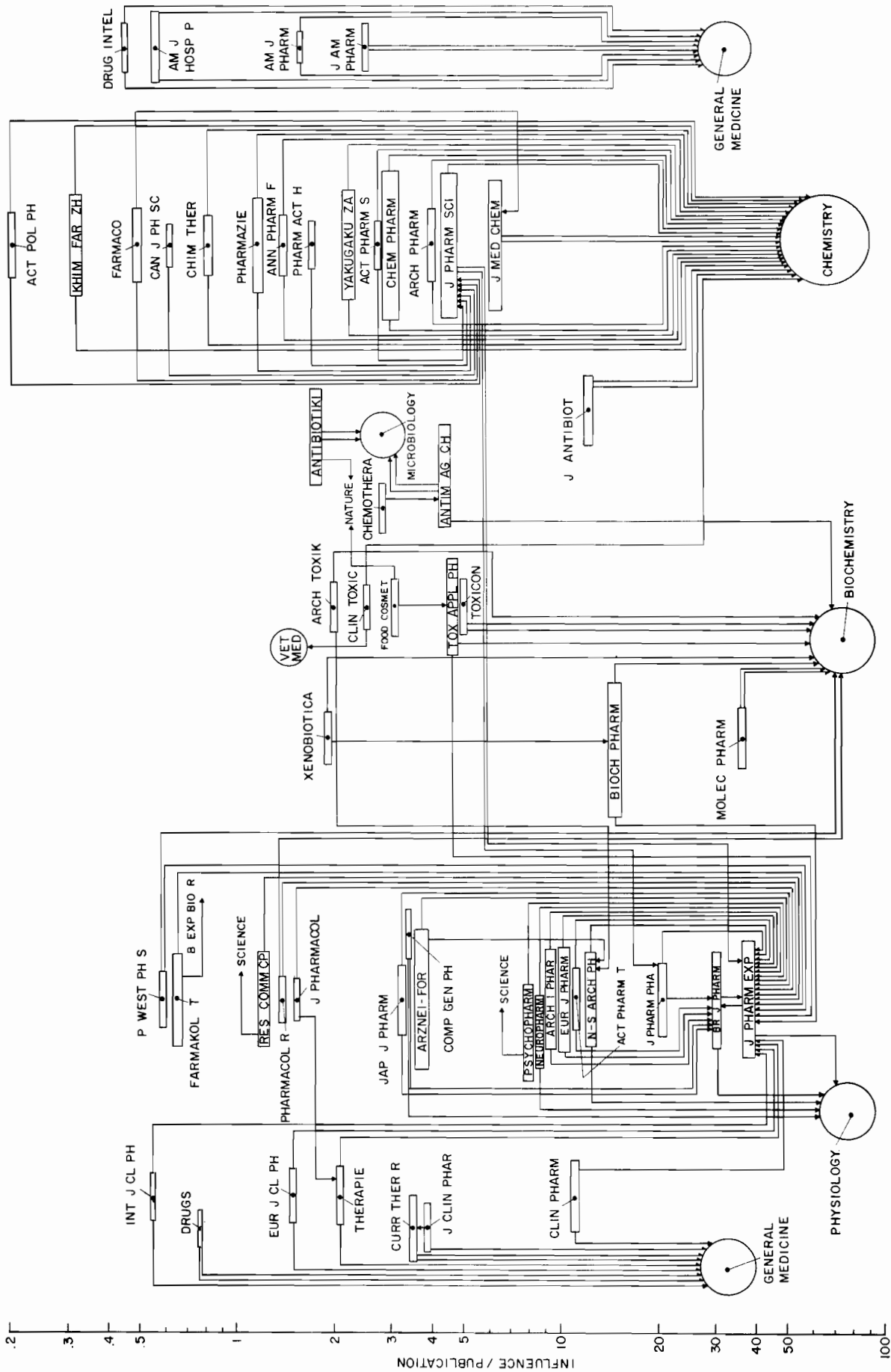

FIGURE 8-53
 INFLUENCE MAP FOR PHARMACOLOGY AND PHARMACY JOURNALS

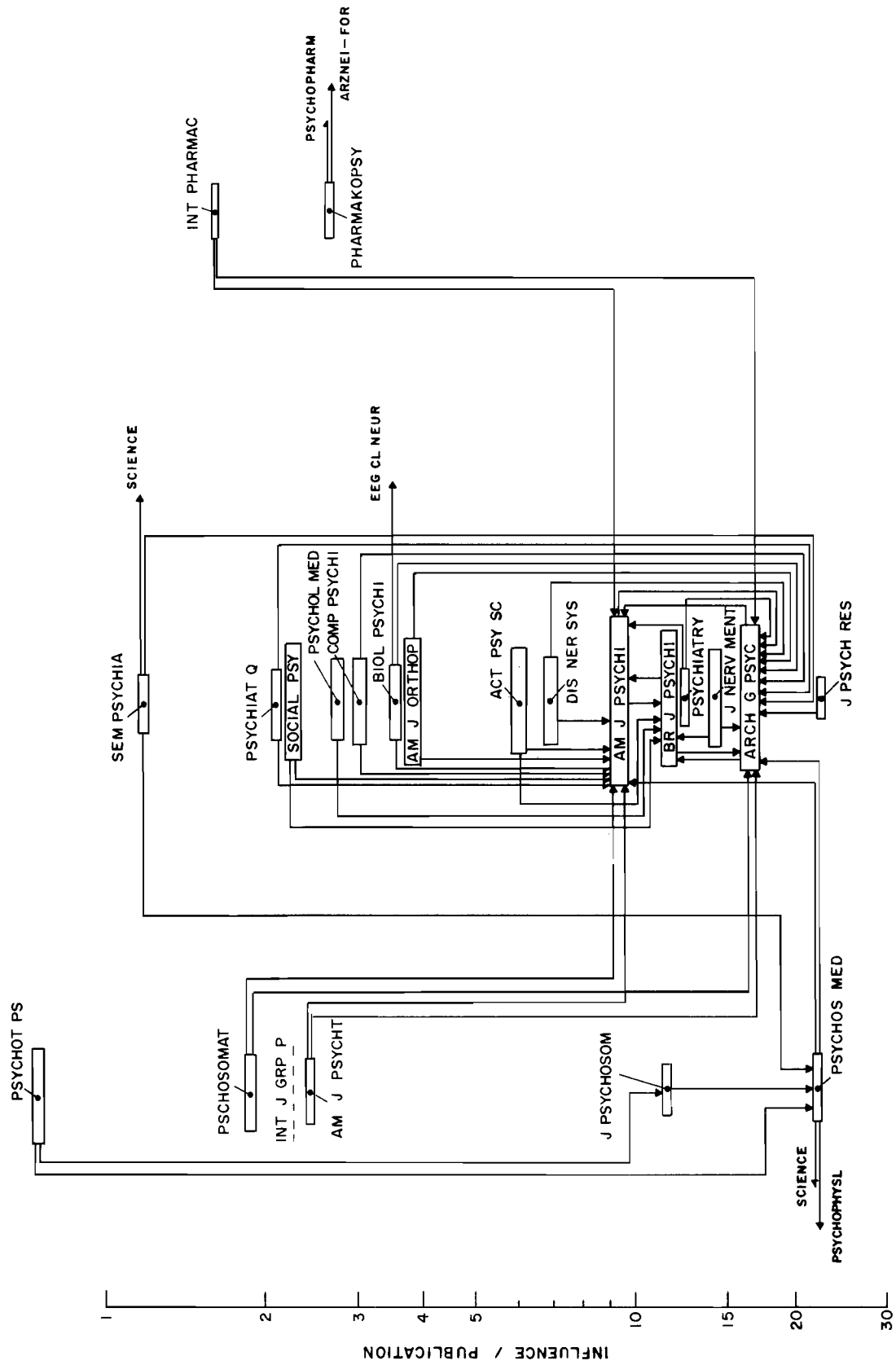

FIGURE 8-54

INFLUENCE MAP FOR PSYCHIATRY JOURNALS

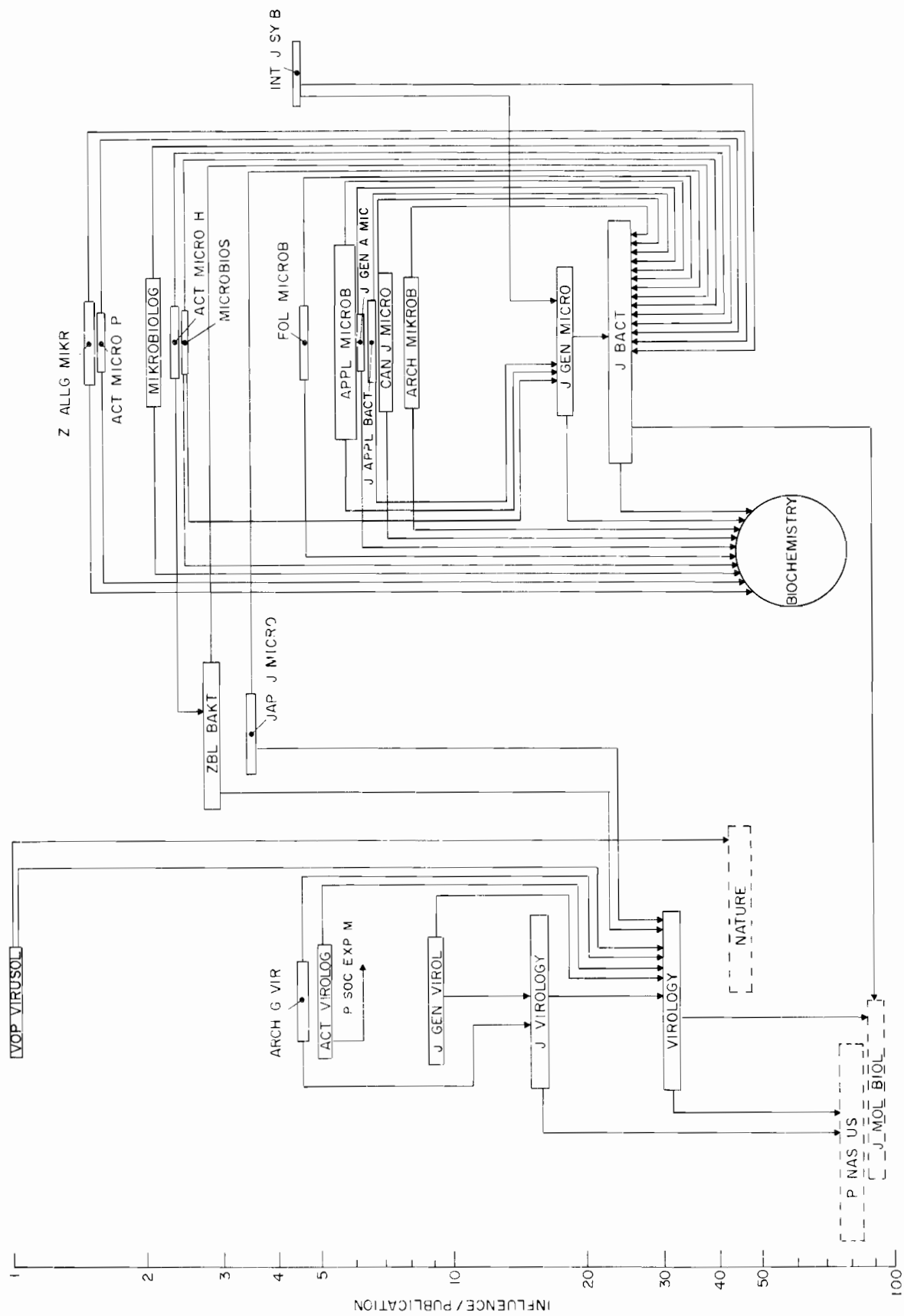

FIGURE 8-55

INFLUENCE MAP FOR VIROLOGY AND MICROBIOLOGY JOURNALS

IX. RELIABILITY

A. Introduction

This chapter describes a preliminary study of the stability of the influence measure, and of the degree of reliability associated with its use. Specifically, the chapter assesses the relationships between the influence measure for a set of papers and the sample sizes necessary to create a desired level of confidence.

When using the influence methodology to compare sets of papers, each individual paper is assessed in terms of the "average" paper within the journal of interest. However, because citation rates to different papers vary widely within a given journal, a variance component is present; the variance component necessitates an analysis of the stability and reliability of such a procedure.

The reliability analysis will be divided into two kinds of comparisons: comparisons of sets of papers, and comparisons of institutions.

Comparisons of Sets of Papers from Two Journals:

Given two separate journals A and B, what is the probability of selecting sets of sample papers from journal A and from journal B such that the sample mean influence is less for journal A than for Journal B, given the difference in true mean influence between journal A and journal B is delta, δ ; where, $\delta > 0$ is the only question of interest.

Statistically, this can be stated as follows:

$$P \left\{ \bar{X}_a - \bar{X}_b \leq 0 \mid \mu_a - \mu_b = \delta, n_a, n_b \right\} = \beta$$

where:

β = the probability of error; i.e., if $\delta > 0$;

\bar{X}_a = sample mean influence of papers from journal a;

\bar{X}_b = sample mean influence of papers from journal b;

μ_a = true but unknown mean influence of papers in journal a;

μ_b = true but unknown mean influence of papers in journal b;

n_a = sample size from journal a;

n_b = sample size from journal b.

Section B-2 shows that differences of 10 to 20 in influence/publication yield acceptable levels of β for relatively small sets of papers. Such a set might represent the publication output for a research institution, educational institution, or a university department.

Comparisons of the Publications of Institutions:

Within any given journal, do the citation patterns show a citation preference for certain institutions or levels of institutions? For example, are the papers from highly prestigious universities cited more than the papers from other institutions? Preliminary data for the larger journals indicate that papers from highly prestigious universities are cited more frequently than papers from less prestigious universities. The two large journals used for this institutional analysis were the Physical Review and the Journal of the American Chemical Society. (See Section D).

B. Comparisons of Sets of Papers from Two Journals

1. Statistical Parameters

Sixteen journals were selected to investigate the question of reliability; four journals were chosen from each of the fields of physics, chemistry, cancer, and biochemistry. Each journal was selected to ensure that it had a different degree of influence within its field.

Table 9-1 lists the journals selected and their influence measures. All the papers from these journals were extracted from the 1970 Science Citation Index (SCI). Next, the references in the 1973 SCI to these 1970 papers were identified. The 1973 SCI references were assigned the influence weights for the journal in which they were published. These influence weighted references were then matched to the cited paper, and the total influence score of each cited paper was calculated. The distributions of influence scores for the 1970 papers were then constructed, and the mean and variance of these distributions computed.

Figure 9-1 shows the distribution of 1973 references (not influence weighted) to the 1970 papers in the Physical Review. In this distribution: (1) the mode occurs at papers cited 2 to 3 times and represents approximately 75% of the papers; (2) the median occurs at approximately 8 citations, which implies that half the citations are to the 93% of papers cited 8 times or less; and, (3) the mean of this curve occurs at approximately the 98 percentile point.

TABLE 9-1*

INFLUENCE MEASURES FOR 16 SELECTED JOURNALS

	Infl Wt	Ref/ Pub	Infl/ Pub	# Pubs	Total Infl
ARCH BIOCH	1.54	22.7	34.9	569	19,869
BIOC BIOP A	1.35	21.1	28.3	2,253	63,827
J BIOL CHEM	3.70	26.2	97.0	1,222	118,497
J LIPID RES	2.83	23.1	65.4	95	6,212
CANCER	0.83	17.3	14.4	436	6,261
CANCER RES	1.09	21.8	23.8	498	11,847
J NAT CAN	0.96	18.9	18.1	457	8,281
ONCOLOGY	0.11	20.7	2.3	73	166
J AM CHEM S	2.20	24.5	53.8	1,813	97,612
J CHEM S	1.41	14.4	20.4	2,962	60,277
J PHYS CHEM S	1.24	16.2	20.1	252	5,078
TETRAHEDRON	0.67	18.6	12.5	552	6,894
J CHEM PHYS	1.36	18.2	24.8	1,448	35,931
NUOV CIM	1.04	13.8	14.3	449	6,425
PHYS REV	1.42	18.6	26.4	3,648	96,307
NUCL PHYS	0.93	21.8	20.2	1,209	24,446

*For full titles of journal titles abbreviated,
please see Appendix II.

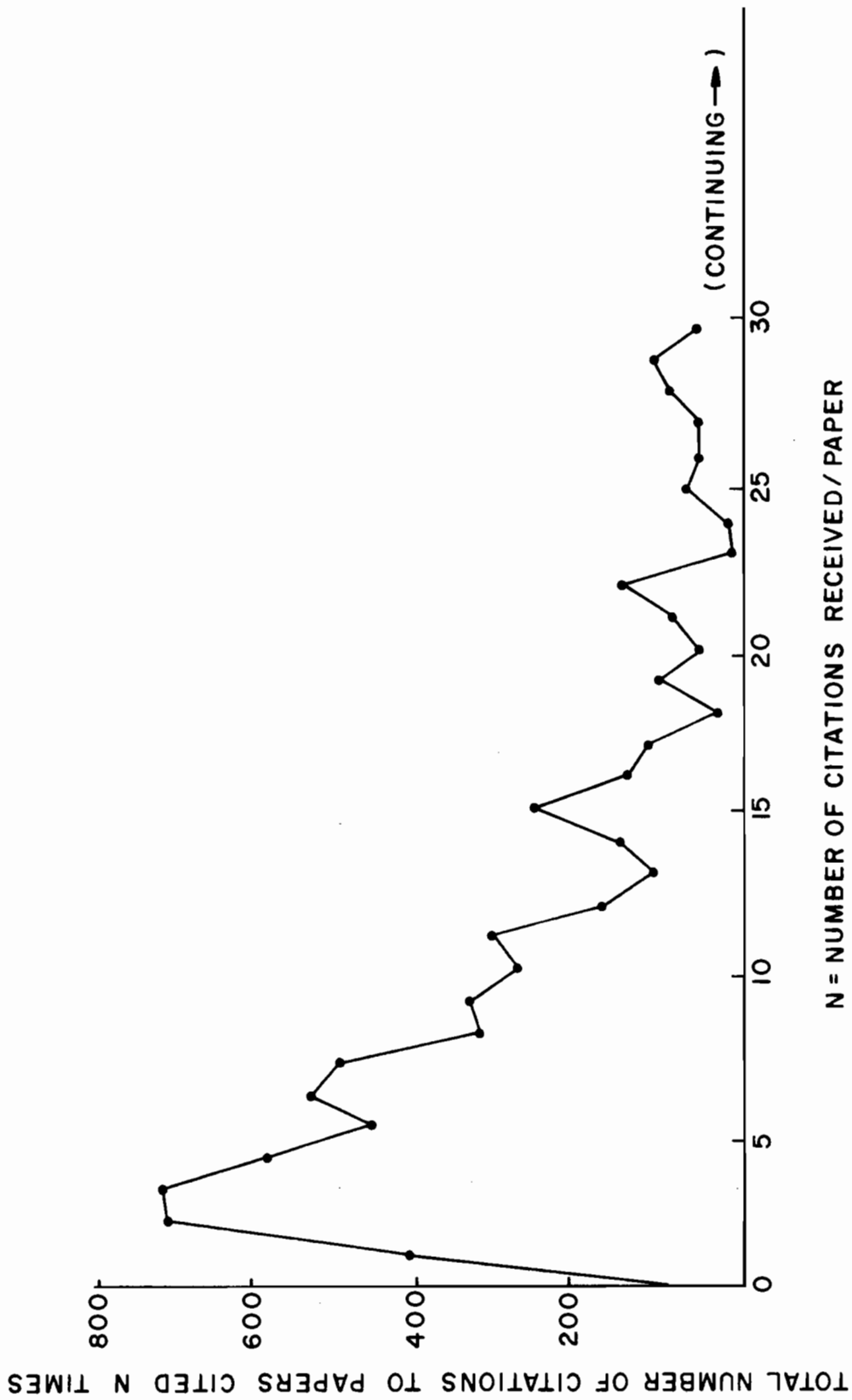

FIGURE 9-1

DISTRIBUTION OF 8083 CITATIONS FROM 1973 PAPERS
TO 3247 PAPERS PUBLISHED IN PHYS REV IN 1970

In comparing the influence score distributions for these 16 journals, a strong linear relationship between the mean and the variance of the distributions is observed; this can be seen in Figure 9-2. Also, a functional and logical consistency emerges between the mean influence scores/publication based on the 1973 references to 1970 papers, and the influence/publication developed for the journals in Chapter VII. This influence/publication was based on 1973 references to all years.

The linear relation between the mean and variance may be seen in the scatter diagram, Figure 9-2. The Physical Review, which has a mean influence/publication of 26.4, has a variance in influence/publication of 50.0; Table 9-2 lists these parameters for all 16 journals. Superimposed on the scatter diagram is a line with a slope of 156 and a 0 intercept. The value for the intercept was forced to 0; the slope is the result of a least squares fit. This modeled relationship between the mean and variance will be used in Section C.

The functional and logical consistency between influence measures based on 1973 references to 1970, and influence measures based on all 1973 references is legitimized in the following way. Consider all of the citations over all of time to the papers of a specific year. Figure 9-3 shows the distribution (relative frequency) of papers which received 0,1,2, etc., citations over their life span.

On the average, a paper tends to receive 10% of its citations three years after publication (the shaded portion of Figure 9-3). The accuracy of this three-year time lag concept can be substantiated by comparing the sample influence/publication, derived here, and the influence/publication measure derived in Chapter VII.

Figure 9-4 illustrates the relationship of the time lag to influence/publication. Note that the scale of the vertical and horizontal axes stands in a 1:10 ratio. Given this scale factor and the lag of three years, a 45° angle line should fit the data of a scatter diagram which places the two measures of influence on opposing axes. This hypothesis receives support both visually from Figure 9-4 and statistically from a chi-square goodness-of-fit analysis which is shown in Table 9-3. Note that the test statistic is $\chi^2 = 20.813$, while the critical test value is $\chi^2(15,0.90)=22.31$. Since the test value is smaller than the critical value, the hypothesis is accepted that a 1:10 ratio exists.

The functional form of the relationship is:

$$Y = P \cdot X$$

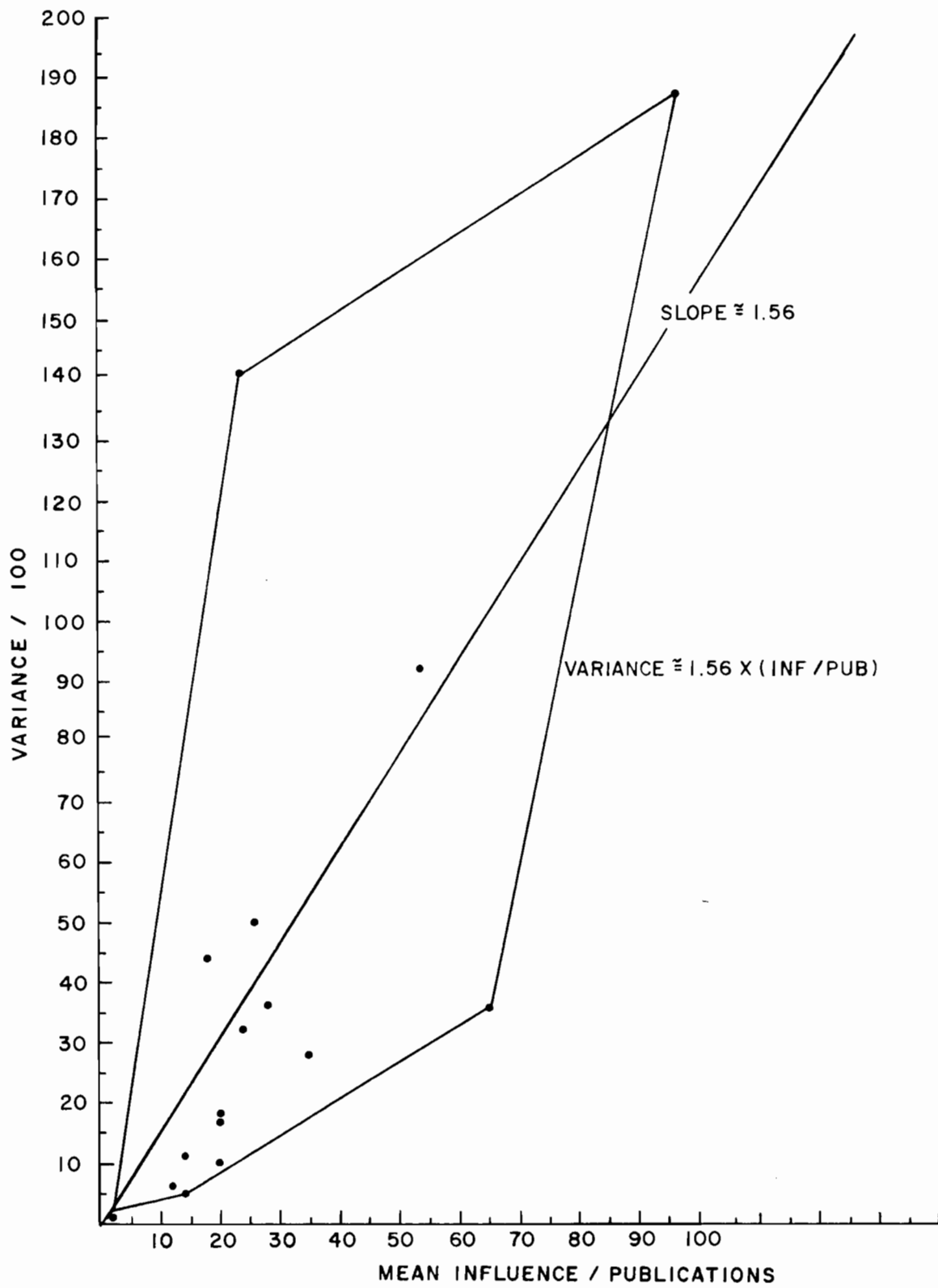

FIGURE 9-2

MEAN INFLUENCE/PUBLICATION

TABLE 9-2

VARIANCE DATA FOR 16 JOURNALS

Journal Name	#	Distribution			Citation Structure	Infl/Pub Mean
		Sample Size	Variance	Mean	Infl/Pub	Ratio
ARCH BIOCH	1	430	27.81	3.85	34.9	9.065
BIOC BIOP A	2	2037	35.92	3.74	28.3	7.567
CANCER	3	352	11.51	1.89	14.4	7.619
CANCER RES	4	434	32.20	3.22	23.8	7.391
J AM CHEM S	5	1790	92.16	4.58	53.8	11.747
J BIOL CHEM	6	922	187.67	8.91	97.0	10.887
J CHEM PHYS	7	1879	141.06	5.28	24.8	4.697
J CHEM S	8	3689	18.10	1.64	20.4	12.439
J LIPID RES	9	82	36.60	4.90	65.4	13.347
J NAT CANC	10	257	44.76	3.22	18.1	5.621
J PHYS CH S	11	324	9.65	1.65	20.1	12.182
NUCL PHYS	12	1380	17.40	2.30	20.2	8.783
NUOV CIM	13	404	5.20	0.98	14.3	14.592
ONCOLOGY	14	40	0.66	0.30	2.3	7.667
PHYS REV	15	3247	49.94	2.94	26.4	8.980
TETRAHEDRON	16	597	6.21	1.27	12.5	9.843

$$b = \frac{\sum xy}{\sum x^2} = 1.56$$

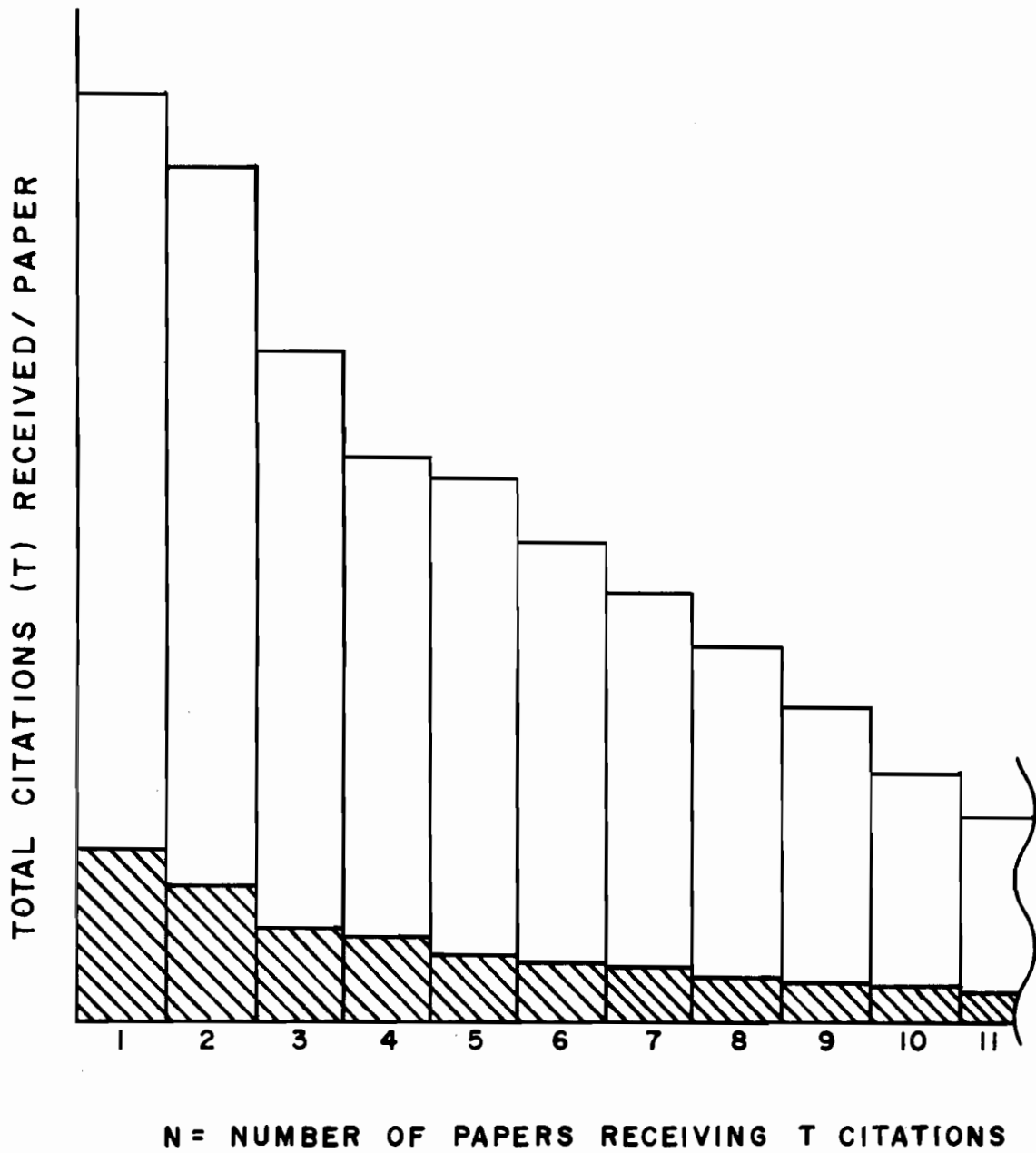

FIGURE 9-3

DISTRIBUTION OF CITATIONS TO PAPERS CITED N TIMES

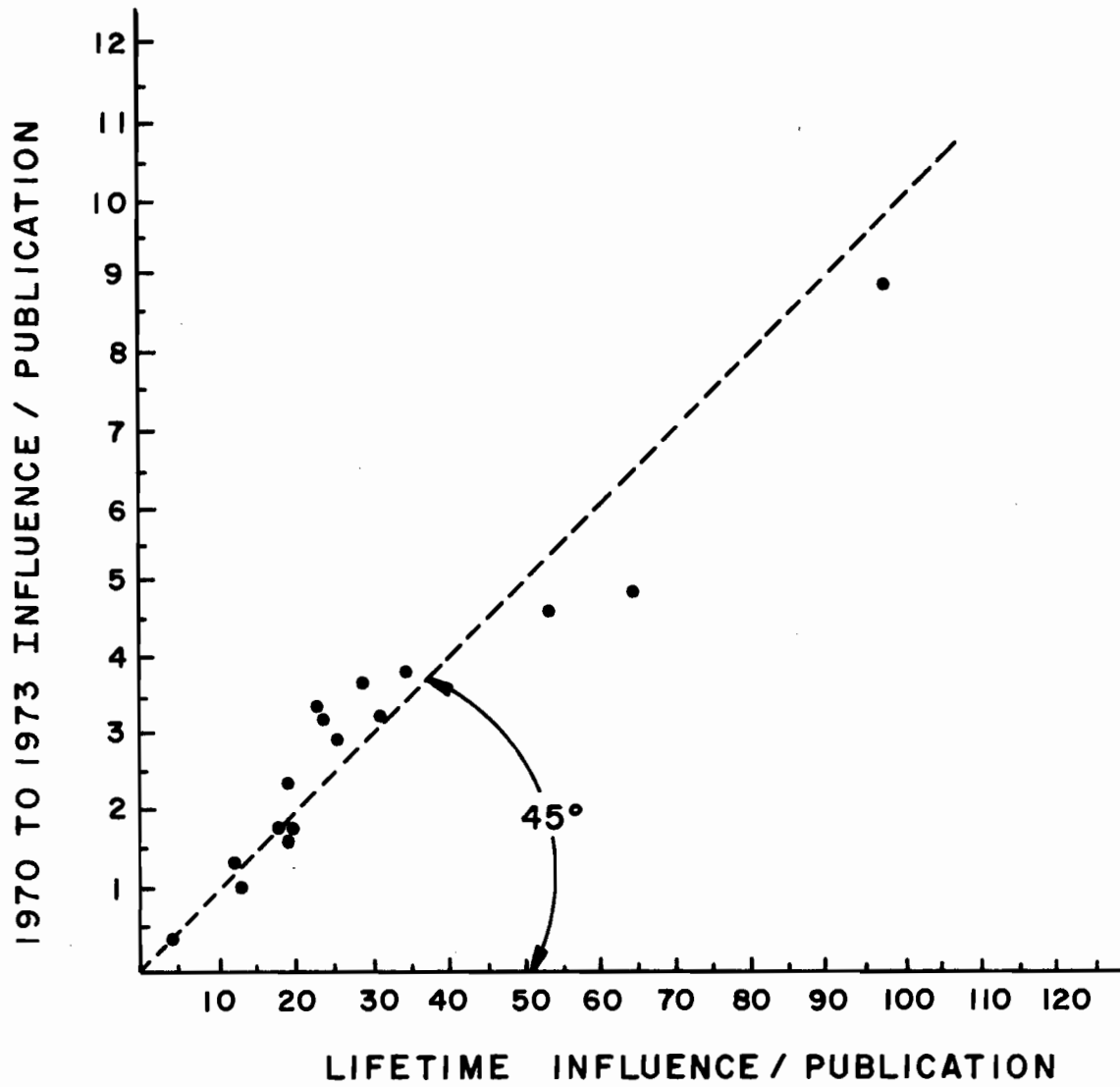

FIGURE 9-4

1973 TO 1970 INFLUENCE VS. LIFETIME INFLUENCE

TABLE 9-3

χ^2 TEST SHOWING 1973 TO 1970 INFLUENCE MEASURES
TO BE 1:10 OF TOTAL LIFETIME INFLUENCE MEASURES

OBSERVATION (10X)	EXPECTED	$\frac{(\text{OBSER}-\text{EXP})^2}{\text{EXP}}$
38.5	34.9	0.371
37.4	28.3	2.214
18.9	18.9	0
32.2	31.3	0.026
45.8	53.8	1.190
89.1	97.0	0.643
32.9	24.8	2.646
16.4	20.4	0.784
49.0	65.4	4.113
32.2	23.8	2.965
16.5	20.1	0.645
23.0	20.2	0.388
9.8	14.3	1.416
3.0	3.0	0
29.4	26.4	3.409
12.7	12.5	0.003
		20.813
	TOTAL	20.813

$$H_0: 10.0 = P$$

$$\chi^2 = 20.813$$

$$H_1: 10.0 = P$$

$$\chi^2 (15, 0.90) = 22.31$$

Accept H_0 since $\chi^2 < \chi^2(15, 0.90)$

where,

Y = influence values for a given year;
X = influence values for theoretically
complete influence structure;
P = proportion of total influence represented by a given year.

If an article has a final influence of 200, its influence, as cited in its third year after publication, would be 20. In the same manner, 300, 400, and 500 would map into 30, 40 and 50.

The axiomatic basis of this section rests on the hypothesized relationship between a single year's citation influence structure and the final distribution of influence for sets of papers. Specifically, the citation lag was hypothesized to be three years, this lag implying a 1:10 ratio between the influence of the papers during the third year after their publication, and the lifetime influence of the papers. This hypothesized relationship has been substantiated.

The other relationship discussed showed a linear relationship between the influence/publication described in Chapter VII and the estimated variance of the distribution of influence for the papers in a journal, based on one year's citations.

In conclusion, the moments of the lifetime distribution of influence among papers in a journal can be estimated by inferring from the distribution created by a single year's citations to a single year's papers.

2. Sample Sizes and the Reliability of the Technique

The introduction to this chapter formulated the original probability question as:

$$P \left\{ \bar{X}_a - \bar{X}_b \leq 0 \mid \mu_a - \mu_b = \delta; n_a, n_b \right\} = \beta$$

An analysis of the functional form of this probability question will demonstrate the stability and reliability of the influence measure. However, inverting the functional form of the equation makes it easier to work with. That is, rather than examine the probability which results from drawing two samples of sizes n_a and n_b , suppose the desired probability is specified first and then the sample sizes necessary to achieve this probability are studied. To simplify the analysis further, assume n_a and $n_b = n$.

Approaching the question from this direction requires two basic steps: 1) convert the probability equation to standardized normal form; and, 2) fix the level of beta, (β), and examine the internal portion of the probability equation to determine sample size. Converting to the standard normal deviate yields

$$P \left\{ Z \leq - \frac{\delta}{\sigma \sqrt{\bar{X}_a - \bar{X}_b}} \mid \mu_a - \mu_b = \delta; N_a, N_b \right\} = \beta,$$

After some standard algebra, statistical logic, and use of the approximation discussed earlier (i.e., $\sigma^2 = 156 \cdot \mu$) the equation reduces to

$$N = \frac{156 \cdot Z^2 \cdot (\mu_a + \mu_b)}{(\mu_a - \mu_b)^2}$$

Note, if a pair of influence/publications is assumed and a level of probability, β , (which in turn specifies a value for Z) is specified, the necessary sample size is directly available. A graphic presentation of this formula is presented in Figure 9-5. For example, assume a pair of influence $\mu_1 = 35$ and $\mu_2 = 10$ which yield $\delta = 35 - 10 = 25$.

Insert these numbers into the above equation:

$$n = \frac{(156)(Z^2)(35+10)}{(35-10)^2}$$

which yields

$$n = 11.232(Z^2).$$

Next, the assumption is made that $\beta = 0.10$, which for a one-tailed test implies $Z \cong 1.29$; and $Z^2 = 1.664$.

Therefore, if $\mu_1 = 35$, $\mu_2 = 10$, and a 90% confidence level is desired, the following sample sizes must be drawn from each journal:

$$n = (11.232)(1.664) = 18.69$$

$$n = 19.$$

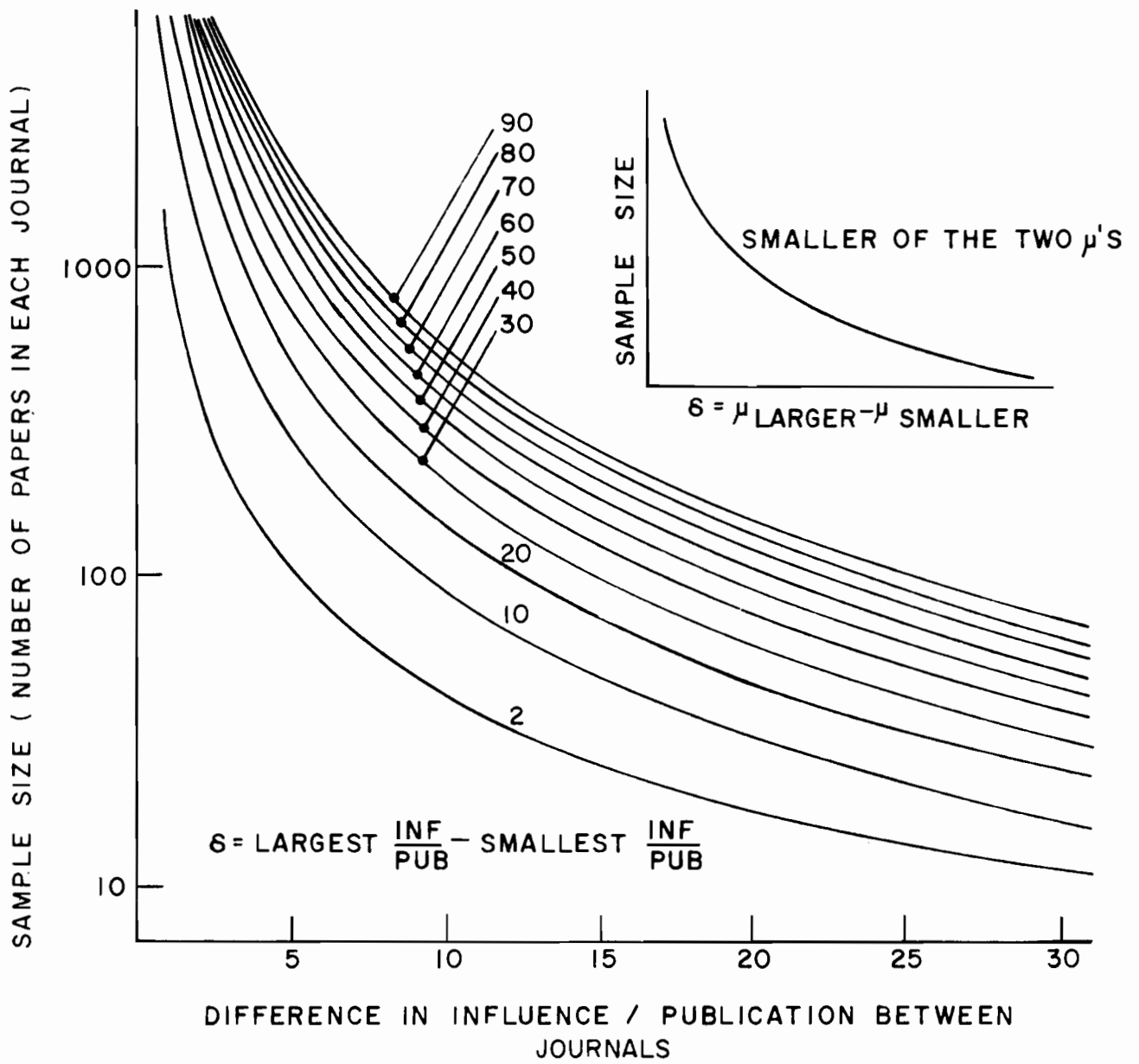

FIGURE 9-5

90% CONFIDENCE CURVES FOR DETERMINING SAMPLE SIZE

Using Figure 9-5 as an alternative approach to solution, locate delta ($\delta = \mu_1 - \mu_2$) on a horizontal axis; move vertically until the curve which represents the smaller of the two influence measures is crossed. Finally move horizontally to the vertical axis where the necessary sample size can be read. Built into the graphic presentation is a factor which slightly over-estimates the sample size and thereby produces a conservative sample estimate. In the present example, the sample size is estimated to be $n = 22$.

An alternate method of graphically formulating the relationship would directly relate sample size and specific levels of confidence. The alternate formulation can be used to determine the sample size necessary to attain a specific level of confidence, given the specific expected influence/publication for each of the journals. Figure 9-6 illustrates this procedure. In this example assume an influence/publication of 20 for the smaller journal. If the influence/publication for the larger journals were 30, leading to a difference in influence/publication of the two journals of 10, then a sample size of about 150 publications per journal is necessary to achieve a 90% confidence level. That is, if 150 papers are selected from each of two journals, one with an expected mean influence per publication of 30 and the other of 20, sample mean influences per publication which support the size directionality of the two journals approximately 90% of the time can be expected. This, of course, is also stating that the sample mean of papers selected from the less influential journal is going to exceed the sample mean of papers selected from the more influential journal 10% of the time. A sample as small as 50 papers would give a confidence level of 75%. If the influence of the largest journal is 40, so that the difference between the journal influence/publication is 20, then 90% confidence level is obtained at about 55 papers, and 75% confidence at only 10 papers.

The range over which this measure is useful, and the range over which the measure will produce statistically significant results depends on two basic relationships: 1) absolute difference in influence, and (2) relative difference in influence. The absolute difference may be examined by considering two journals, one of which has an influence/publication of 10 and one of 25. Here the absolute difference is 15. This absolute value, however, would also apply to two journals, one of which had an influence/publication of 40 and the other of 55. Yet, an examination of either Figure 9-5 or 9-6 shows that different sample sizes result. This is a function of relative influence/publication. Relative influence/publication interplays in this manner because of the functional relationship between mean influence and variance of influence. That is, variance is approximated by multiplying the mean by 156. Note that as mean influence increases the variance also increases, which then infers that the sample size must increase to hold the probability at a constant level.

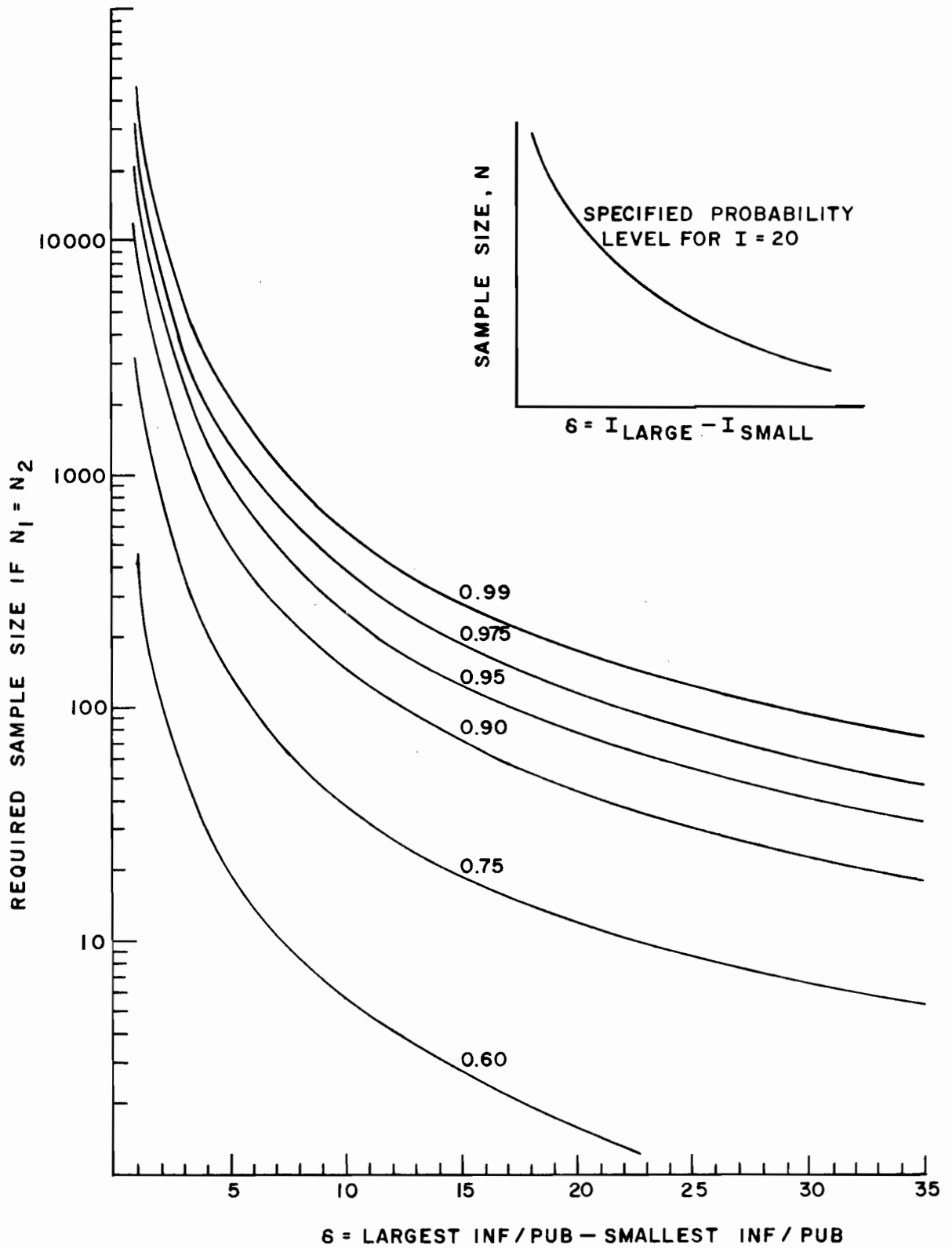

FIGURE 9-6

CONFIDENCE LEVELS FOR A FIXED INFLUENCE/PUBLICATION = 20.0

C. Comparison of the Publications of Institutions

Direct institutional comparisons can be inferred by comparing the calculated influence/publication for the publications of two institutions whose publications are distributed over many different journals. While a direct study of such institutional comparisons has not been made, the comparison is logically equivalent to the comparisons of sets of papers made in the previous section. In making this comparison a major underlying assumption will be uniformity of citation and influence patterns across institutions within journals. This assumption will be examined in Section D.

For example, consider all the publications of University A. Assume that these publications define a pseudo-journal to be called Journal UA, while the publications of another University B are collected into a pseudo-journal which is called Journal UB. Having created these journals in abstraction, the moments of the distribution of citations to the papers in the pseudo-journals can then be compared and analyzed as described in the last section. The following is a brief outline of how such a set of pseudo-journals representing the publications of the universities or university departments can be developed.

The construction of pseudo-journals uses the following notational scheme: superscripts will refer to institutions; subscripts to journals. Consequently, $f^i(x)$ will refer to the pseudo-journal representing institution i , while $f_j(x)$ will refer to journal j . A_i^j will refer to the attribute A for institution i and journal j . The construction of a pseudo-journal for an institution is:

$$f^i(x) = P_1^i f_1(x) + P_2^i f_2(x) + \dots + P_k^i f_k(x)$$

where P_j^i represents the proportion of articles, from institution i which are published in journal j ; further

$$\sum_{j=1}^k P_j^i = 1.$$

The moments about the origin for this function can be shown to be:

$$E \left[\chi^{(r)} \right] = \sum_{j=1}^k P_j^i \mu_j^{(r)}$$

where $\mu_j^{(r)}$ is the expectation of the r^{th} moment around zero for journal j .

Using this result, the mean value of a pseudo-journal function can be shown to be:

$$E [x] = \sum_{j=1}^k P_j \mu_j$$

The variance is:

$$E [x - \mu]^2 = \sum_{j=1}^k (P_j^2) (\sigma_j^2)$$

Questions concerning sample sizes, error probabilities, and inferential questions are now functionally equivalent to the previous section. These pseudo-journals, however, will require different curves since the variance-mean functional relationship is altered.

D. Citations to Institutions

Within the 16 journals for which 1973 citations to 1970 publications were available, Computer Horizons has investigated the variance of citation patterns to an institution's publications from institution to institution. Because the citation rate from one year to another is not large, the investigation utilized only the two largest journals, Physical Review and Journal of the American Chemical Society, and then only for aggregates of institutions. For Physical Review, the publications from the most prestigious schools were cited twice as frequently as those from the least prestigious schools. For the Journal of the American Chemical Society, the papers from the most prestigious schools were cited 1.5 times as frequently as those from the least prestigious schools. This analysis is described in the following paragraphs.

Initially some 22 universities were chosen, covering the complete range of quality in the Roose-Andersen report in the areas of physics and chemistry. Significant differences between individual institutions could not be tested even in the largest journals. The most prolific institutions publish only 30-40 articles a year in Physical Review, the giant among American physics journals. When those articles are distributed according to the number of citations they receive, the number of articles falling into each cell is far too small even in the range of 0-10 citations where most of the articles fall.

Aggregates of institutions were then formed. Since the main interest of the investigation was to see whether prestigious institutions would receive more citations per paper than average, the aggregations were based on the Roose-Andersen quality rankings. For physics the aggregates shown in Table 9-4 were formed. University of California and State University of New York were eliminated because their campuses were not separated in the publication data.

Publication and citation counts for Physical Review for those groups of schools are given in Table 9-5. The table gives data for both raw citations and influence weighted citations. The mean number of citations/publication follows a general downward trend from Group 1 to Group 8 in both cases. This may also be seen in Figure 9-7. A one-way analysis of variance was performed to see if a significant difference among the means of all 8 groups existed. That test indicated that there was a less than 1 in 1,000 chance that the sample means obtained could have been drawn from 8 populations whose true means were equal. In Table 9-6 the group pairs whose sample means are significantly different (95% confidence) are indicated by '+', the others with a "-". The weighted citations/publication data were used to compile Table 9-6. The table indicates that the significant differences are between two sets, the first being formed by groups 1-2 and the second being composed of groups 3-8. There is also a visible, if not significant, downward trend from group 3 through group 8.

Table 9-7 and 9-8 present the data for Journal of the American Chemical Society. The groups were formed in a manner similar to those for Physical Review, but without dividing the "strong" quality schools into two groups. Therefore, no Journal of the American Chemical Society groups have the same quality levels as groups 5 and 6 did in the case of the Physical Review aggregation. The consistent downward trend for the means from group 1 may be seen in Figure 9-7. The one-way analysis of variance test indicated that there was a less than 1 in 100 chance that the sample means obtained could have been drawn from 7 populations whose true means were equal. Table 9-8 summarizes the significance tests for pairs of groups. Only two pairs have means that are different at the 95% confidence level.

Summarizing this chapter, the influence methodology seems to be a viable alternative to individual citation counts for sets of 50 or more papers. In these cases, if a substantial difference in average influence is found, one can predict, with reasonable confidence, a difference in influence between the two sets of papers.

In addition, the Physical Review and Journal of the American Chemical Society data indicate that the publications of the faculty members of highly prestigious universities are

somewhat more highly cited than publications of faculty members of other universities.

The combination of difference in influence/publication for the journals plus the tendency for the publications of the prestigious universities to be more highly cited, would tend to reinforce any difference obtained by ascribing the general influence to sets of publications when comparing the publications of prestigious and less prestigious universities.

TABLE 9-4

AGGREGATION OF PHYSICS DEPARTMENTS

Group 1: Top 5

Cal Tech
Harvard
Princeton
MIT
Stanford

Group 2: Second 5

Columbia
Illinois
Chicago
Cornell
Yale

Group 3: Next 7

Wisconsin
Michigan
Pennsylvania
Maryland
Rockefeller
Rochester
Minnesota

Group 4: Next 10

Washington (Seattle)
Carnegie-Mellon
Brown
Duke
Johns Hopkins
Purdue
Brandeis
Colorado
Iowa State
Texas

Group 5: Strong Eastern

Florida
Florida State
NYU
North Carolina
Penn State
Pittsburgh
Rutgers
Syracuse
Virginia
Yeshiva

Group 6: Strong Western

Case-Western Reserve
Indiana
Michigan State
Northwestern
Notre Dame
Ohio
Oregon
Southern Cal
Washington (St. Louis)

Group 7: Intermediate

Arizona
Georgia Tech
Ill Inst Tech
Iowa
Kansas
LSU
No. Carolina State
Oregon State
Temple
Tennessee
Utah
Vanderbilt
Wayne State

Group 8: Unranked

43 Other Schools

Note: Groups 5 and 6 have the same Roose-Andersen Quality.

TABLE 9-5

1973 CITATIONS TO 1970 PHYSICAL REVIEW
PUBLICATION FOR GROUPS OF UNIVERSITIES

	All	1	2	3	4	5	6	7	8	
Phys Rev	All									
Cites	7449	3298	870	664	405	405	327	265	174	188
Pubs	3248	1386	250	215	187	225	167	129	93	121
Mean										
Cites/Pub	2.29	2.38	3.48	3.09	2.17	1.80	1.97	2.05	1.86	1.55
Var										
Cites/Pub	17.3	20.9	50.6	16.2	11.8	5.9	8.1	17.2	12.8	6.6
Wt Cites*	9072	4124	1053	801	525	528	401	331	228	258
Pubs	3248	1386	250	215	187	225	167	129	93	121
Mean										
Wt Cites/Pub	2.79	2.98	4.22	3.72	2.81	2.35	2.41	2.56	2.44	2.13
Var										
Wt Cites/Pub	23.6	27.7	72.3	22.1	15.5	9.4	10.6	26.8	30.8	14.1

*Wt Cites: Citations weighted by the influence weight of the citing journal.

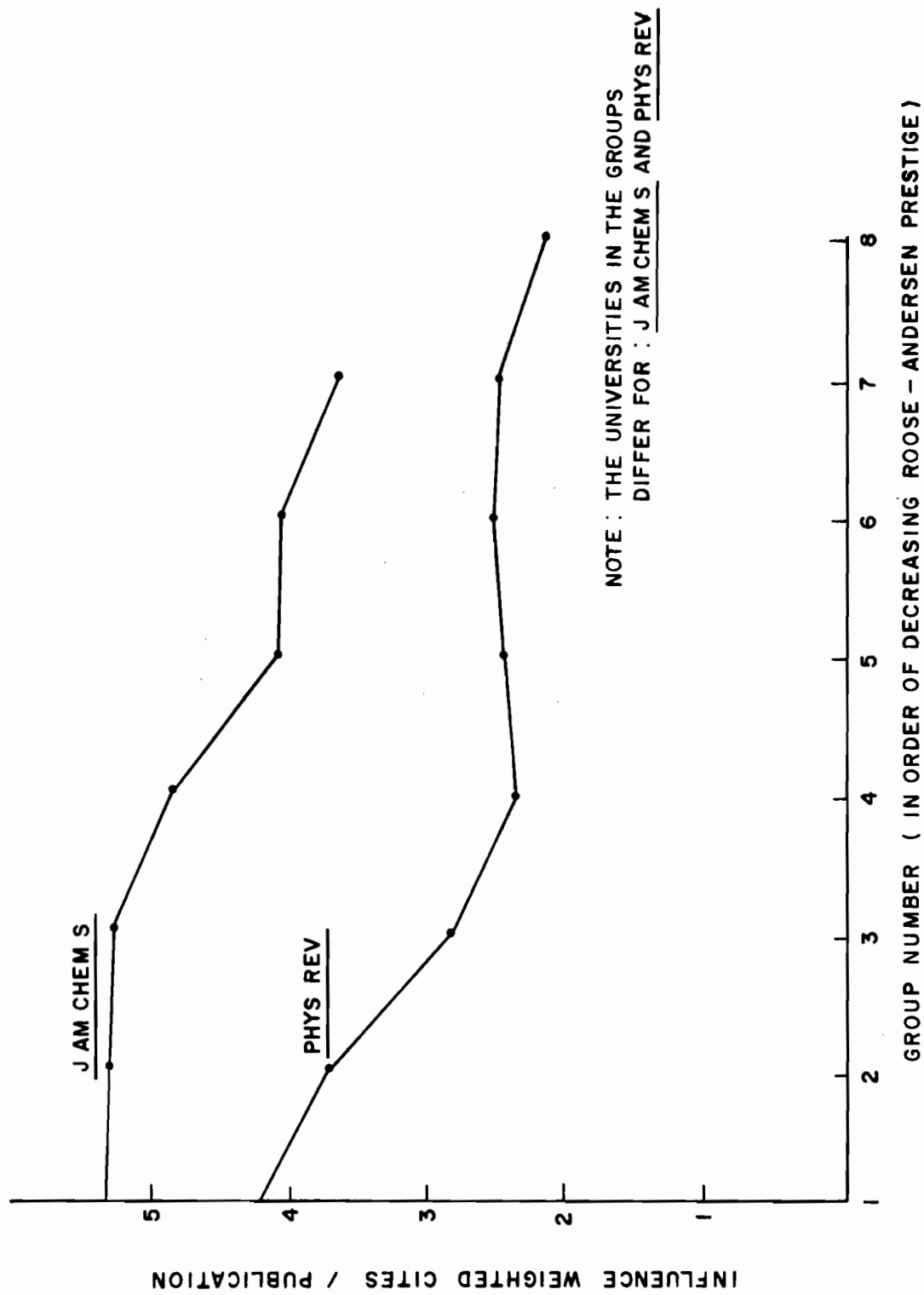

FIGURE 9-7
CITATIONS FROM 1973 TO THE 1970 PUBLICATIONS
OF GROUPS OF UNIVERSITIES

TABLE 9-6

GROUP PAIRS WITH SIGNIFICANTLY DIFFERENT
CITATION/PUBLICATION MEANS--PHYSICAL REVIEW

	1	2	3	4	5	6	7
2	-						
3	+	+					
4	+	+	-				
5	+	+	-	-			
6	+	+	-	-	-		
7	+	-	-	-	-	-	
8	+	+	-	-	-	-	-

TABLE 9-7

1973 CITATIONS TO THE 1970 JOURNAL OF THE AMERICAN
CHEMICAL SOCIETY OF GROUPS OF UNIVERSITIES

	All JACS	Group Number							
		1	2	3	4	5	6	7	
Wt Cites	8325	5077	1018	1021	1013	1060	462	339	163
Pubs	1793	1035	190	192	193	218	113	83	45
Mean									
Wt Cites/Pub	4.64	4.91	5.35	5.32	5.25	4.87	4.08	4.07	3.63
Var									
Wt Cites/Pub	20.1	23.8	28.4	31.5	49.6	28.2	21.6	21.8	29.6

F=2.88
.01 > P >
.001

TABLE 9-8

UNIVERSITY GROUP PAIRS WITH SIGNIFICANTLY
DIFFERENT CITATION/PUBLICATION MEANS --
JOURNAL OF THE AMERICAN CHEMICAL SOCIETY

	1	2	3	4	5	6
2	-					
3	-	-				
4	-	-	-			
5	+	+	-	-		
6	-	-	-	-	-	
7	-	-	-	-	-	-

X. APPLICATION TO UNIVERSITY RANKING

A. Introduction

In Chapter V, the correlation between literature based and non-literature based measures was discussed. The discussion included a brief synopsis of 24 different studies which looked at this type of correlation. Included among those studies were four studies (Cartter,¹ Drew,² Hagstrom³ and Solomon⁴) which dealt with correlations between Roose-Andersen and Cartter report rankings of universities and literature (publication) based rankings of the same universities.

In this chapter a series of strong correlations will be shown between publication ranking of universities and the Roose-Andersen rankings. These correlations are based on 133,000 publications in 11 different fields, far more publications and far more fields than analyzed by any previous study. Further, it will be shown that influence weighting of the publication counts demonstrably increases the correlations. Finally, it will be shown that the Roose-Andersen rankings are a function of both size and influence, and that there may be a "halo" effect (an effect from neighboring departments) in the Roose-Andersen ranks.

B. Publication Data Base

The publication data base used in the analysis was extracted from an existing file of publications of 135 U.S. universities which were among the top 250 NIH grantee institutions from 1965 to 1973. The specific publications analyzed were all those publications listed under all variants of the 135 institutional names in the Corporate Index of the Science Citation Index from 1965 to

¹Alan M. Cartter, An Assessment of Quality in Graduate Education, (Washington, D.C.: American Council on Education, 1966).

²David E. Drew and Ronald S. Karpf, Evaluating Science Departments: A New Index, (Rand Corporation Paper Series, October 1975).

³Warren O. Hagstrom, "Inputs, Outputs, and the Prestige of University Science Departments," Sociology of Education 1971 44 (Fall):375-397.

⁴Warren E. Solomon, "Correlates of Prestige Rankings of Graduate Programs in Sociology," American Sociologist 7 (May 1972):13-14.

1973 inclusive. To avoid the effects of changes in SCI coverage, the publication counts were restricted to a fixed journal set of those journals which were covered continuously by the SCI from 1965 to 1973. If the authors of a publication were affiliated with more than one institution, the publication was apportioned among the different institutions. Since the Roose-Andersen study was done in 1969, the 1965 to 1973 publication set evenly spans the time period from four years before to four years after the Roose-Andersen study. On a year-to-year basis the correlations were somewhat lower than the correlations for all nine years' publications combined. No significant trends appeared in the year-to-year data.

Because the publication data were extracted from an already existing set, the number of schools which could be matched with Roose-Andersen differed from field to field. The number of schools compared varied from a low of 56 in pharmacology, to a high of 89 in chemistry. The University of California was omitted from the comparisons in every field because the individual campuses of the university are not easily separable in the SCI data prior to 1973.

For schools with distinct campuses, the campus with the highest publication count was chosen in each field. For example, for Harvard University the Boston campus had far more publications in biochemistry than Harvard-Cambridge; thus in the biochemistry comparison the count was for Harvard-Boston. For the physical sciences counts, where Harvard-Cambridge was the larger, the counts for Harvard-Cambridge were used. This would probably be the campuses the Roose-Andersen participants had in mind. The alternatives to this strategy would have been either to combine the campuses or to omit the schools with multiple campuses completely. Such an omission would have eliminated a number of major schools and seemed unfair. A brief analysis showed that combining the campuses would have a minimal effect on the publication ranks of the individual schools and, therefore, on the comparisons with the Roose-Andersen data.

Table 10-1 summarizes the scope of the data base. The first column of the table shows the Roose-Andersen field. Under the Roose-Andersen field are the individual subfields of journals used for comparison with the Roose-Andersen field. Appendix I lists the individual journals included in each of these fields. Of the journals listed in the Appendix, only those that were covered continuously by the Science Citation Index since 1965 were included. An informal check of the publications from these universities revealed that approximately 90% of their 1965 through 1973 SCI covered publications appear in the fixed journal set.

The second column of Table 10-1 shows the number of schools that were common to the Roose-Andersen ranking and the publication data and were, therefore, included in the correlation analysis. Column 3 shows the number of journals covered for each field, while Column 4 shows the number of publications (articles, notes

TABLE 10-1

PUBLICATION DATA BASE

Roose-Andersen Field Publication Subfields	# of Schools Common to Roose-Andersen & Publication Set	# of Journals in Set	# Publications (Articles, Notes, Reviews) in Publication Set
BIOCHEMISTRY	86	27	19,794
Biochemistry & Molecular Biology			
CHEMISTRY	89	130	30,465
Analytical Chemistry			
Organic Chemistry			
Inorganic & Nuclear Chemistry			
Applied Chemistry			
General Chemistry			
Polymers			
Physical Chemistry			
DEVELOPMENTAL BIOLOGY	75	21	2,673
Embryology			
Genetics & Heredity			
GEOLOGY	57	53	4,853
Geology			
Earth & Planetary Science			
MATHEMATICS	82	57	13,198
Probability & Statistics			
Applied Mathematics			
General Mathematics			
Miscellaneous Mathematics			
MICROBIOLOGY	87	20	5,844
Microbiology			
Virology			
PHARMACOLOGY	56	19	3,475
Pharmacology			

TABLE 10-1 (Continued)

PUBLICATION DATA BASE

Roose-Andersen Field Publication Subfields	# of Schools Common to Roose-Andersen & Publication Set	# of Journals in Set	# Publications (Articles, Notes, Reviews) in Publication Set
PHYSICS	84	125	36,903
Chemical Physics			
Solid State Physics			
Fluids & Plasmas			
Applied Physics			
Acoustics			
Optics			
General Physics			
Nuclear & Particle Physics			
Miscellaneous Physics		15	3,497
PHYSIOLOGY	86		
Physiology			
PSYCHOLOGY	84	31	9,627
Clinical Psychology			
Personality & Soc. Psychology			
Develop. & Child Psychology			
Experimental Psychology			
General Psychology			
Miscellaneous Psychology		14	2,270
ZOOLOGY	79		
General Zoology			
Miscellaneous Zoology			
	<hr/>	<hr/>	<hr/>
	Total = 865	Total = 512	Total = 132,599
	Average = 75	Average = 47	Average = 12,054

and reviews) in the count for each field. This count varies from a low of 2,270 publications in the field of zoology to 36,903 publications in physics. The total count of publications in all fields is 132,599, a sizeable publication base for the comparisons.

C. Correlations between Publication Counts and Roose-Andersen Rankings

Table 10-2 summarizes the Spearman rank correlations between the publication rankings of the schools and their Roose-Andersen rankings. Three different sets of Spearman rank correlation are given: 1) between the Roose-Andersen score and the number of university publications, 2) between the Roose-Andersen score and the average influence/publication of the university publications, and 3) between the Roose-Andersen score and the total influence of the university publications. As before, total influence is defined by

$$\text{Total Influence} = \sum_{\substack{\text{all} \\ \text{journals} \\ j}} \left(\begin{array}{c} \text{influence/} \\ \text{publication} \\ \text{of } j\text{th} \\ \text{journal} \end{array} \right) \times \left(\begin{array}{c} \text{No. of publications} \\ \text{in } j\text{th journal} \end{array} \right)$$

The number of publications from a university is a size-dependent measure, while the influence/publication is a size-independent measure of the influence of the journals in which the university is publishing. The total influence is then a combined measure of size and influence.

The first observation from Table 10-2 is that all of the correlations between Roose-Andersen ranks and number of university publications are high and significant. The range of Spearman rank correlation for total publications is 0.654 to 0.857. In addition, the field by field correlations are highly significant, with z values ranging from a low of 6.73 in pharmacology to a high of 18.49 in physics. There is clearly a substantial correlation between this publication size measure and a university's Roose-Andersen ranking.

The next column, correlations between Roose-Andersen rank and influence/publication, also reveals notable correlations, most of which are between 0.50 and 0.725. All of these correlations are significant, with the single exception of geology, for which the publications of the various schools seem to be distributed rather uniformly among the journals at various levels of influence. Since influence/publication is the closest publication measure to "quality", or size-independent influence, the Roose-Andersen rankings also seem to reflect the quality or influence of the journals in which the universities are publishing. The rankings correlate with influence/publication to a

TABLE 10-2

SPEARMAN RANK CORRELATIONS BETWEEN PUBLICATION
RANKINGS AND ROOSE-ANDERSEN RANKINGS

Field	# of Universities	# of Publications	Correlation with Total # of Publications	Correlation With Influence/ Publication	Correlation With Total Influence
Biochemistry	86	19,794	0.827 (13.50)*	0.723 (9.60)	0.856 (15.21)
Chemistry	89	30,465	0.804 (12.62)	0.694 (8.98)	0.855 (15.36)
Developmental Biology	75	2,673	0.635 (7.02)	0.287 (2.56)	0.647 (7.25)
Geology	57	4,853	0.713 (7.54)	0.068 (0.51)	0.716 (7.61)
Mathematics	82	13,198	0.699 (8.75)	0.834 (13.53)	0.852 (14.57)
Microbiology	87	5,844	0.703 (9.11)	0.507 (5.42)	0.812 (12.81)
Pharmacology	56	3,475	0.675 (6.73)	0.551 (4.85)	0.731 (7.86)
Physics	84	36,903	0.898 (18.49)	0.545 (5.89)	0.910 (19.82)
Physiology	86	3,497	0.694 (8.84)	0.549 (6.01)	0.746 (10.27)
Psychology	84	9,627	0.721 (9.43)	0.720 (9.39)	0.859 (15.21)
Zoology	79	2,270	0.654 (7.60)	0.275 (2.51)	0.777 (10.82)

*Values in parantheses are the standard normal deviate (z value) which indicates the number of standard deviations by which the value differs from the mean.

lesser degree than they correlate with the size of a university as measured by total publications. However, it should be noted that the average influence/publication for the smaller schools may be affected by the switch of a few publications from one journal to another; as a result this measure may not be as stable as number of publications.

The last column in the table, correlations with total influence, shows that in every field the correlations between the Roose-Andersen ranking and the publication ranking increase when size, as measured by total publications, and quality, as measured by influence per publication, are combined into total influence.

Figure 10-1 graphically shows the effect of influence weighting on these rank correlations. The foot of each arrow lies along the diagonal at the value of the Spearman rank correlation between total publication count and the Roose-Andersen rankings. The head of the arrow shows the correlation between total influence and the Roose-Andersen ranking. In every case there is an increase in the correlation when influence/publication is included in the publication measure. The field which has the smallest increase in correlation, geology, had a very small influence/publication correlation. Developmental biology also had a relatively small correlation between the Roose-Andersen and the influence/publication. Physics, the only other field that does not show a notable increase, had such an extremely high correlation of 0.898 on publication count alone, that the influence weighting only minimally increases this correlation.

Overall, the addition of the influence/publication "quality" factor yields a definite increase in the correlations between publication ranking and the Roose-Andersen ranking.

D. Further Correlation Analysis

In the previous section it was shown that the separation of publication count and influence/publication could be used to differentiate some of the effects of quality and size in Roose-Andersen type rankings. In this section, it will be shown that these techniques can also be used to isolate somewhat the "halo" effect, or the effect of neighboring departments, upon the responses of Roose-Andersen participants.

A reasonable assumption can be made that a scientist judging the quality of a university's graduate faculty in an academic department would probably be affected by his perception of the overall prestige of the university. It is also certainly true that the larger, more prestigious schools are generally strong in all fields. This section will show that while the prestigious universities are usually prestigious in all fields, the Roose-Andersen results probably overestimate this prestige.

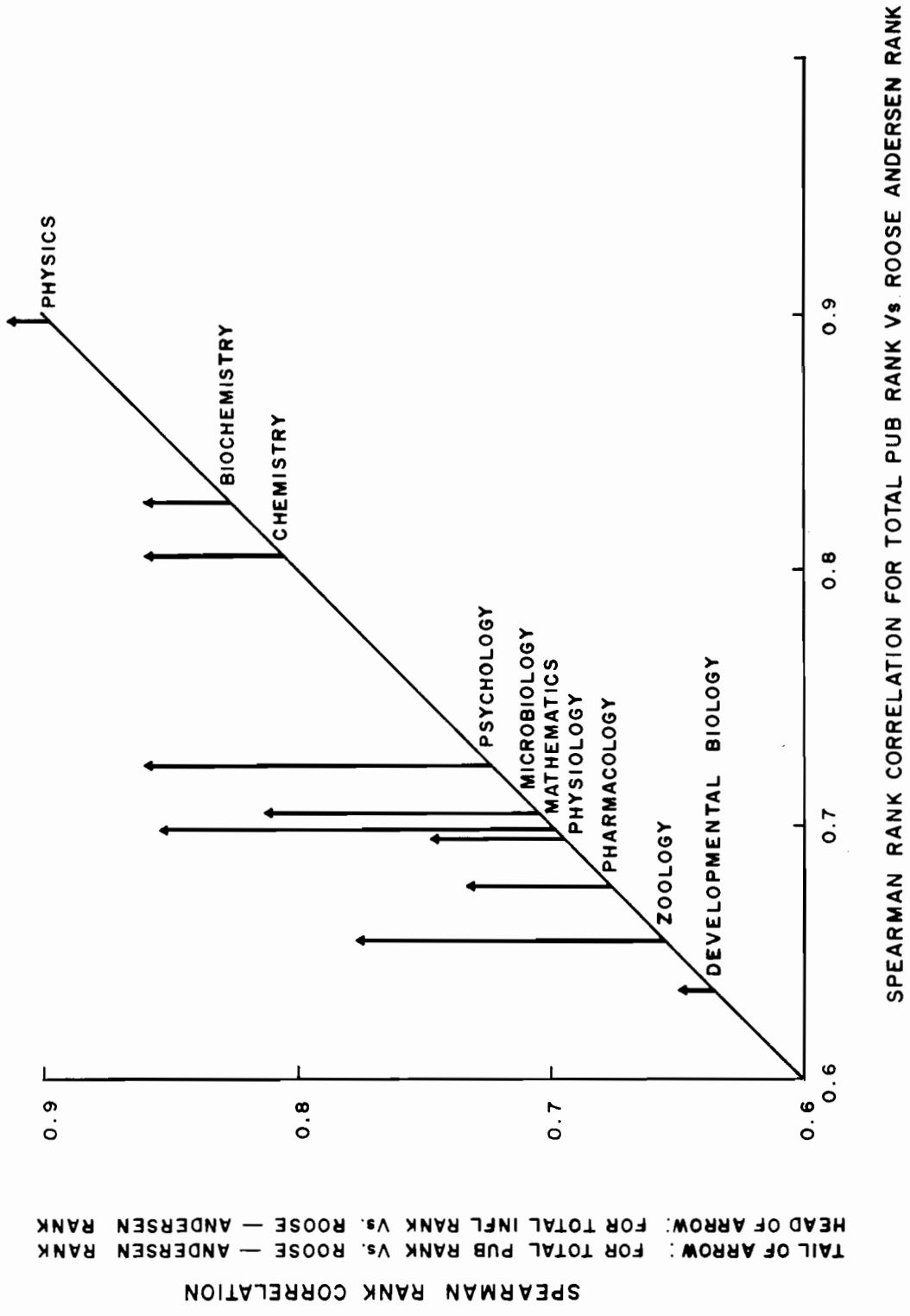

SPEARMAN RANK CORRELATION

TAIL OF ARROW : FOR TOTAL PUB RANK VS. ROOSE - ANDERSEN RANK

HEAD OF ARROW : FOR TOTAL INFL RANK VS. ROOSE - ANDERSEN RANK

SPEARMAN RANK CORRELATION FOR TOTAL PUB RANK VS. ROOSE ANDERSEN RANK

FIGURE 10-1

SPEARMAN RANK CORRELATION FOR PUBLICATION AND INFLUENCE
WEIGHTED PUBLICATION RANK VS. ROOSE-ANDERSEN RANK

Table 10-3 shows the Spearman rank correlations between the Roose-Andersen rankings of the universities in different fields. The schools which were not common to the rankings in each pair of fields were eliminated from the computation. Note that the correlations are high: there are 17 cross field correlations between 0.80 and 0.89, and 19 correlations between 0.70 and 0.79. The average correlation on the table is 0.72, quite high, although considerably less than the 0.80 average correlation between total influence and Roose-Andersen scores within a single field.

Table 10-4 shows the Spearman rank correlations between the total publication rankings of the universities in the different fields. These cross field correlations are lower than those based on Roose-Andersen rankings; only two correlations are higher than 0.80 and only three lie between 0.70 and 0.79. The average correlation on the table is 0.55, substantially lower than the 0.72 average found for the cross field Roose-Andersen correlations.

From the viewpoint of the graduate student, who would certainly benefit from having high quality faculty available to him in many departments, the "halo" aspect of the Roose-Andersen ranking might be more beneficial than detrimental. However, from the viewpoint of the ranking of the quality of graduate faculty, field-to-field university rankings are far less uniform when based on publication counts.

A table similar to Table 10-4, for total influence, also has an average correlation of 0.55 and reveals much the same correlation patterns and overall relationships.

It is interesting to note that the highest correlation on Table 10-4 is 0.86 between the fields of chemistry and physics, while the next highest correlation, 0.80, is between mathematics and physics. The correlation between mathematics and chemistry is also high at 0.78. Rankings of schools in chemistry, physics and mathematics seem particularly closely related.

Table 10-5 takes this analysis to its last step, comparing the Spearman rank correlations between the universities, ranked according to average influence/publication. In this case the average correlation on the table is only 0.35, lower than the average cross field correlation based on total publications or total influence, and much lower than the correlations based on Roose-Andersen ranking.

Overall, the separation of size (as measured by publications) and quality (as measured by influence/publication) provides support for the hypothesis that the Roose-Andersen rankings are affected by the size of the departments and by the overall prestige of the university. The evaluative bibliometric techniques illustrated in this chapter show how a publication analysis can be used to substantiate and measure these qualitative effects.

TABLE 10-3

CROSS FIELD CORRELATIONS FOR ROOSE-ANDERSEN SCORE

	BIOCHEMISTRY	CHEMISTRY	DEVELOP. BIOLOGY	GEOLOGY	MATHEMATICS	MICROBIOLOGY	PHARMACOLOGY	PHYSICS	PHYSIOLOGY	PSYCHOLOGY	ZOOLOGY
BIOCHEMISTRY	1.00										
CHEMISTRY	0.78	1.00									
DEVELOP. BIOLOGY	0.81	0.75	1.00								
GEOLOGY	0.57	0.71	0.59	1.00							
MATHEMATICS	0.77	0.82	0.70	0.70	1.00						
MICROBIOLOGY	0.87	0.71	0.83	0.52	0.73	1.00					
PHARMACOLOGY	0.58	0.57	0.38	0.50	0.47	0.54	1.00				
PHYSICS	0.85	0.88	0.77	0.68	0.87	0.79	0.66	1.00			
PHYSIOLOGY	0.83	0.66	0.73	0.60	0.68	0.72	0.68	0.78	1.00		
PSYCHOLOGY	0.73	0.81	0.74	0.67	0.73	0.76	0.69	0.82	0.72	1.00	
ZOOLOGY	0.81	0.82	0.89	0.66	0.80	0.82	0.55	0.81	0.75	0.80	1.00

TABLE 10-4

CROSS FIELD CORRELATIONS FOR TOTAL NUMBER OF PUBLICATIONS

	BIOCHEMISTRY	CHEMISTRY	DEVELOP. BIOLOGY	GEOLOGY	MATHEMATICS	MICROBIOLOGY	PHARMACOLOGY	PHYSICS	PHYSIOLOGY	PSYCHOLOGY	ZOOLOGY
BIOCHEMISTRY	1.00										
CHEMISTRY	0.54	1.00									
DEVELOP. BIOLOGY	0.57	0.58	1.00								
GEOLOGY	0.64	0.61	0.42	1.00							
MATHEMATICS	0.53	0.78	0.60	0.57	1.00						
MICROBIOLOGY	0.66	0.58	0.72	0.44	0.59	1.00					
PHARMACOLOGY	0.58	0.55	0.47	0.52	0.52	0.50	1.00				
PHYSICS	0.61	0.86	0.64	0.72	0.80	0.55	0.55	1.00			
PHYSIOLOGY	0.67	0.25	0.53	0.38	0.36	0.37	0.64	0.42	1.00		
PSYCHOLOGY	0.53	0.65	0.60	0.47	0.67	0.66	0.65	0.60	0.42	1.00	
ZOOLOGY	0.44	0.53	0.58	0.49	0.47	0.56	0.52	0.52	0.34	0.56	1.00

TABLE 10-5

CROSS FIELD CORRELATION FOR INFLUENCE PER PUBLICATION

	BIOCHEMISTRY	CHEMISTRY	DEVELOP. BIOLOGY	GEOLOGY	MATHEMATICS	MICROBIOLOGY	PHARMACOLOGY	PHYSICS	PHYSIOLOGY	PSYCHOLOGY	ZOOLOGY
BIOCHEMISTRY	1.00										
CHEMISTRY	0.46	1.00									
DEVELOP. BIOLOGY	0.18	0.36	1.00								
GEOLOGY	0.24	0.27	0.17	1.00							
MATHEMATICS	0.60	0.47	0.11	0.45	1.00						
MICROBIOLOGY	0.66	0.42	0.21	0.34	0.48	1.00					
PHARMACOLOGY	0.31	0.12	0.30	0.24	0.43	0.43	1.00				
PHYSICS	0.43	0.41	0.15	0.18	0.45	0.38	0.05	1.00			
PHYSIOLOGY	0.45	0.50	0.22	0.30	0.49	0.56	0.16	0.56	1.00		
PSYCHOLOGY	0.51	0.53	0.06	0.20	0.60	0.38	0.32	0.41	0.47	1.00	
ZOOLOGY	0.31	0.15	0.06	0.43	0.34	0.57	0.35	0.11	0.44	0.35	1.00

REFERENCES

A. Bibliography

- Alker, Hayward R., Jr. Mathematics and Politics. New York: The Macmillan Company, 1965.
- Allen, Edward S. "Periodicals for Mathematicians." Science 70 (December 20, 1929):592-594.
- Anthony, L.J., East, H., and Slater, M.J. "The Growth of Literature in Physics." Reports on the Progress of Physics 32 (1969):709-767.
- Baker, Dale B. "World's Chemical Literature Continues to Expand." Chemical and Engineering News 49 (July 13, 1971):37-40.
- Barr, K.P. "Estimates of the Number of Currently Available Scientific and Technical Periodicals." Journal of Documentation 23 (June 1967):110-116.
- Barrett, Richard L. and Barrett, Mildred A. "Journals Most Cited by Chemists and Chemical Engineers." Journal of Chemical Education 34 (January 1957):35-38.
- Bayer, Alan E. and Astin, Helen S. "Sex Differentials in the Academic Reward System." Science 188 (May 23, 1975):796-802.
- Bayer, Alan E. and Folger, John. "Some Correlates of a Citation Measure of Productivity in Science." Sociology of Education 39 (1966):381-390.
- Bradford, S.C. Documentation. London: Crosby, 1948.
- Brookes, B.C. "Bradford's Law and the Bibliography of Science." Nature 224 (December 1969):953-956.
- Brookes, B.C. "The Complete Bradford-Zipf Bibliograph." Journal of Documentation 25 (March 1969):58-61.
- Brookes, B.C. "The Derivation and Application of the Bradford-Zipf Distribution." Journal of Documentation 24 (December 1968):247-265.
- Brookes, B.C. "The Design of Cost-Effective Hierarchical Information Systems." Information Storage and Retrieval 6 (1970): 127-136.
- Brookes, B.C. "Optimum P% Library of Scientific Periodicals." Nature 232 (August 1971):458-459.
- Brookes, B.C. "Scientific Bibliography." (Letter) Nature 227 (September 1970):1377.

- Brown, Charles Harvey. Scientific Serials. Chicago:Association of College and Reference Libraries (ACRL Monograph No. 6) 1956.
- Bourne, Charles P. "The World's Journal Literature: An Estimate of Volume, Origin, Language, Field, Indexing, and Abstracting." American Documentation (April 1962):159-168.
- Burton, Robert E. "Citations in American Engineering Journals I. Chemical Engineering." American Documentation (1959):70-73.
- Bush, William C; Hamelman, Paul W., and Staaf, Robert J. "A Quality Index for Economics Journals." Review of Economics and Statistics 56 (February 1974):123-125.
- Carpenter, Mark P. and Narin, Francis. "Clustering of Scientific Journals." Journal of the American Society for Information Science 24 (November/December 1973):425-426.
- Cartter, Allan M. An Assessment of Quality in Graduate Education. Washington, D.C.:American Council on Education, 1966.
- Cason, Hulsey, and Lubotsky, Marcella. "The Influence and Dependence of Psychological Journals on Each Other." Psychological Bulletin 33 (1936):95-103.
- Clark, Beverly L. "Multiple Authorship Trends in Scientific Papers." Science 143 (February 1964):822-824.
- Clark, Kenneth E. America's Psychologists: A Survey of a Growing Profession. Washington, D.C.: American Psychological Association, 1957.
- Cohen-Shanin, Naomi. Innovation and Citation. Jerusalem: November 1974. Unpublished.
- Coile, Russell C. "Information Sources for Electrical and Electronics Engineers." IEEE Transactions on Engineering Writing and Speech EWS-12 (October 1969):71-78.
- Coile, Russell C. "Periodical Literature for Electrical Engineers." Journal of Documentation 8 (December 1952):209-226.
- Cole, F.J. and Eales, Nellie B. "The History of Comparative Anatomy." Science Progress 11 (1917):578-596.
- Cole, Jonathan R. and Cole, Stephen. "The Ortega Hypothesis." Science 178 (October 27, 1972):368-375.
- Cole, P.F. "A New Look at Reference Scattering." Journal of Documentation 18 (June 1962):54-64.
- Cole, Stephen, and Cole, Jonathan R. "Scientific Output and Recognition." American Sociological Review 62 (1967):377-390.

- Computer Horizons, Inc. Evaluation of Research in the Physical Sciences Based on Publications and Citations. Washington, D.C.: National Science Foundation, Contract No. NSF-C627, November 1973.
- Cox, Eli III, Hamelman, Paul W., and Wilcox, James B. "Relational Characteristics of the Business Literature: An Interpretive Procedure." The Journal of Business 49 (April 1976).
- Crane, Diana. "Scientists at Major and Minor Universities: A Study of Productivity and Recognition." American Sociological Review 30 (October 1965):699-714.
- Crane, Diana. "Social Structure in a Group of Scientists: A Test of the 'Invisible College' Hypothesis." American Sociological Review 34 (June 1969):335-352.
- "Criminology Research: How Good and How Useful?" Mosaic 7 (March/April 1975):15-17.
- Croft, Kenneth. "Periodical Publications and Agricultural Analysis." Journal of Chemical Education 18 (1941):315-316.
- Dalziel, Charles F. "Evaluation of Periodicals for Electrical Engineers." Library Quarterly 7 (1937):354-372.
- Daniel, Robert S., and Louttit, C.M. Professional Problems in Psychology. New York: Prentice-Hall, 1953.
- Dennis, Wayne. "Bibliographies of Eminent Scientists." The Scientific Monthly (September 1954):180-184.
- Dennis, Wayne. "Predicting Scientific Productivity in Later Maturity from Records of Earlier Decades." Journal of Gerontology 9 (1954):465-467.
- DeWitt, Thomas W. Further Inputs to Decision Making. National Science Foundation. Unpublished.
- Drew, David E, and Karpf, Ronald S. Evaluating Science Departments: A New Index. Rand Corporation Paper Series, October 1975.
- Eiudson, Bernice T. "Productivity Rates in Research Scientists." American Scientist 54 (1966):57-63.
- Fairthorne, Robert A. "Empirical Hyperbolic Distributions (Bradford-Zipf-Mandelbrot) for Bibliometric Description and Prediction." Journal of Documentation 25 (December 1969):319-343.
- Fussler, Herman H. "Characteristics of the Research Literature Used by Chemists and Physicists in the United States." Library Quarterly 19 (January 1949):19-35.

- Fussler, Herman H. "Characteristics of the Research Literature used by Chemists and Physicists in the United States, Part II." Library Quarterly 19 (January 1949):119-143.
- Garfield, Eugene. "Citation Analysis as a Tool in Journal Evaluation." Science 178 (November 3, 1972):472-479.
- Garfield, Eugene. "Citation Indexes for Science." Science 122 (July 15, 1955):108-111.
- Gilbert, G. Nigel and Woolgar, Steve. "The Quantitative Study of Science: An Examination of the Literature." Science Studies 4 (1974):279-294.
- Gillmor, C.S. "Citation Characteristics of the JATP Literature." Journal of Atmospheric and Terrestrial Physics 37 (November 1975):1401-1404.
- Glenn, Norval D. and Villemez, Wayne, "The Productivity of Sociologists at 45 American Universities." American Sociologist 5 (August 1970):244-252.
- Goffman, William, and Morris, Thomas G. "Bradford's Law and Library Acquisitions." Nature 226 (June 1970):922-923.
- Goffman, William, and Warren, Kenneth S. "Dispersion of Papers Among Journals Based on a Mathematical Analysis of Two Diverse Medical Literatures." Nature 221 (March 1969):1205-1207.
- Gottschalk, Charles M., and Desmond, Winifred F. "World-Wide Census of Scientific and Technical Serials." American Documentation 14 (July 1963):188-194.
- Gregory, Jennie. "An Evaluation of Medical Periodicals." Medical Library Association Bulletin 25 (1937):172-188. (see also 1935)
- Gross, P.L.K. and Gross, E.M. "College Libraries and Chemical Education." Science 66 (October 28, 1927):1229-1234.
- Gross, P.L.K. and Woodford, A.O. "Serial Literature Used by American Geologists." Science 73 (June 19, 1931):660-664.
- Hackh, Ingo. "The Periodicals Useful in the Dental Library." Medical Library Association Bulletin 25 (1936):109-112.
- Hagstrom, Warren O. "Inputs, Outputs, and the Prestige of University Science Departments." Sociology of Education 44 (Fall 1971): 375-397.
- Harrold, Raymond W. "An Evaluation of Measureable Characteristics Within Army Laboratories." IEEE Transactions on Engineering Management EM-16 (February 1969):16-23.

- Hawkins, R.G, Ritter, L.S, and Walter, I. "What Economists Think of Their Journals." New York University, Graduate School of Business Administration Working Paper Series, No. 72-36, 1972.
- Henkle, Herman H. "The Periodical Literature of Biochemistry." Medical Library Association Bulletin 27 (1938):139-147.
- Hooker, Ruth H. "A Study of Scientific Periodicals." Review of Scientific Instruments 6 (November 1935):333-338.
- Hulme, E.W. Statistical Bibliography in Relation to the Growth of Modern Civilization. London: Grafton, 1923.
- Inhaber, H. "Distribution of World Science." To be published in Geoforum 6 (January 1976).
- Inhaber, Herbert. "Is There a Pecking Order in Physics Journals?" Physics Today (May 1974):39-44.
- Institute for Scientific Information. Science Citation Index.[®] Philadelphia, Pa., 19106.
- Institute for Scientific Information, Science Citation Index Guide and Journal Lists.[®] Philadelphia, Pa., 19106, 1974.
- Institute for Scientific Information, Social Science Citation Index Guide and Journal Lists.[®] Philadelphia, Pa., 19106, 1974.
- Institute for Scientific Information. Source Publications Science Citation Index.[®] Philadelphia, Pa., 19106, January 1, 1975.
- Interactions of Science and Technology in the Innovation Process. Columbus, Ohio: Battelle Columbus Laboratories, March 19, 1973. Final Report Prepared for the National Science Foundation, Contract NSF-C667.
- Jenkins, R.L. "Periodicals for Child-Guidance Clinics." Mental Hygiene 16 (1932):624-630.
- Kendal, M.G. "The Bibliography of Operational Research." Operational Research Quarterly 11 (March/June 1960):31-36.
- Kessler, M.M. "Bibliographic Coupling Between Scientific Papers." American Documentation (January 1963):10-25.
- Kessler, M.M. "Some Statistical Properties of Citations in the Literature of Physics." Statistical Association Methods in Mechanized Documentation (Symposium Proceedings, 1964) Washington, D.C.: National Bureau of Standards Miscellaneous Publication 269, 1965.

- Knudson, Dean D. and Vaughn, Ted R. "Quality in Graduate Education: A Re-evaluation of the Rankings of Sociology Departments in the Cartter Report." American Sociologist 4 (February 1969): 12-19.
- Kochen, M. Principles of Information Retrieval. New York: John Wiley & Sons, Inc., 1974.
- Krevitt, Beth and Griffith, Belver C. "A Comparison of Several Zipf-Type Distributions in their Goodness of Fit to Language Data." Journal of the American Society for Information Science 23 (May/June 1972):220-221.
- Kruskal, J.B. "Non-Metric Multidimensional Scaling: A Numerical Method." Psychometrica 29 (June 1964):115-129.
- Lawani, S.M. "Bradford's Law and the Literature of Agriculture." International Library Review 5 (1973):341-350.
- Lehman, Harvey C. "The Chemist's Most Creative Years." Science 127 (May 23, 1958):1213-1222.
- Lehman, Harvey C. "The Creative Production Rates of Present Versus Past Generations of Scientists." Journal of Gerontology 17 (1962):409-417.
- Leimkuhler, Ferdinand F. "The Bradford Distribution." Journal of Documentation 23 (September 1967):197-207.
- Lightfield, Timothy E. "Output and Recognition of Sociologists." American Sociologist 6 (May 1971):128-133.
- Line, Maurice B., and Sandison, A. "Obsolescence and Changes in the Use of Literature with Time." Journal of Documentation 30 (September 1974):283-350.
- Lotka, Alfred J. "The Frequency Distribution of Scientific Productivity." Journal of the Washington Academy of Sciences 16 (June 1926):317-323.
- McCauly, James E. "Multiple Authorship." Science 141 (August 1963): 579.
- McNeely, J.K. and Crosno, C.D. "Periodicals for Electrical Engineers." Science 72 (July 25, 1930):81-84.
- Menard, Henry W. Science: Growth and Change. Cambridge, Mass.: Harvard University Press, 1971.
- Mengert, William F. "Periodicals on the Endocrinology of Sex." Endocrinology 18 (1934):421-422.

- Merton, Robert K. "Properties in Scientific Discovery" in The Sociology of Science. ed. Norman W. Storer. Chicago: University of Chicago Press, 1973.
- Middleton, Gerard V. "Citation Patterns of Papers Published in the Journal of Sedimentary Petrology." Journal of Sedimentary Petrology 44 (March 1974):3-6.
- Moravcsik, Michael J. and Murugesan, Poovanalingam. Some Results of the Classification of Citation Records of Individual Scientists. Unpublished.
- Moravcsik, Michael J. and Murugesan, Poovanalingam. "Some Results on the Function and Quality of Citations." Social Studies of Science 5 (January 1975):86-92.
- Moravcsik, Michael J., Murugesan, Poovanalingam, and Shearer, Evelyn. An Analysis of Citation Patterns in Indian Physics. Unpublished
- Myers, Roger C. "Journal Citations and Scientific Eminence in Contemporary Psychology." American Psychologist 25 (1970): 1041-1048.
- Narahan, S. "Bradford's Law of Bibliography of Science: An Interpretation." Nature 227 (August 1970):631-632.
- Narin, Francis, and Carpenter, Mark P. "National Publication Comparisons." Journal of the American Society for Information Science 26 (March-April, 1975):80-93.
- Narin, Francis, Carpenter, Mark P., and Berlt, Nancy C. "Interrelationships of Scientific Journals." Journal of the American Society for Information Science 23 (Sept.-Oct. 1972):323-331.
- Narin, Francis, and Garside, Daniel. "Journal Relationships in Special Education." Exceptional Children (May 1972):695-704.
- Narin, Francis and Sierecki, Joan J. The Collection and Analysis of Health Services Research Journal Literature 1965 to 1969. Computer Horizons, Inc. for National Center for Health Services Research and Development, Contract No. HSM 110-70-290, April 1971.
- National Science Board. Science Indicators 1972. Washington, D.C.: U.S. Government Printing Office, 1973.
- National Science Foundation. A Price Index for Academic R&D Expenditures. Washington, D.C.: U.S. Government Printing Office, May 1972.
- Orr, Richard H. and Leeds, Alice A. "Biomedical Literature Volume Growth and Other Characteristics." Federation Proceedings 23 (November-December 1964):1310-1331.

- Price, Derek J. de Solla. Little Science, Big Science. New Haven: Yale University Press, 1963.
- Price, Derek J. de Solla. "Measuring the Size of Science." Proceedings of the Israel Academy of Science and Humanities 6 (1969):10-11.
- Price, Derek J. de Solla. "Nations Can Publish or Perish." Science and Technology 70 (October 1967):84-90.
- Price, Derek J. de Solla. "Networks of Scientific Papers." Science 149 (July 30, 1965):510-515.
- Price, Derek J. de Solla. Science Since Babylon. Enlarged edition. New Haven: Yale University Press, 1975.
- Roose, Kenneth D. and Andersen, Charles J. A Rating of Graduate Programs. Washington, D.C.: American Council on Education, 1970.
- Saracevic, Tefko, ed. Introduction to Information Science. New York: R.R. Bowker Co., 1970.
- Schmookler, Jacob. Invention and Economic Growth. Cambridge, Mass.: Harvard University Press, 1966.
- Shaw, Byron T. The Use of Quality and Quantity of Publication as Criteria for Evaluating Scientists. Washington, D.C.: U.S.D.A. Miscellaneous Publication No. 1041, January 1967.
- Shepard, R.N. "The Analysis of Proximities: Multidimensional Scaling with an Unknown Distance Function, Part One." Psychometrika 27 (June 1962):125-140.
- Shepard, R.N. "The Analysis of Proximities: Multidimensional Scaling with an Unknown Distance Function, Part Two." Psychometrika 27 (September 1962):219-246.
- Sheppard, Oden E. "The Chemistry Student Still Needs a Reading Knowledge of German." Journal of Chemical Education 12 (October 1935):472-473.
- Sherwin, C.W. and Isenson, R.S. First Interim Report on Project HINDSIGHT (Summary). Washington, D.C.: Office of the Director of Defense Research and Engineering, June 30, 1966.
- Shockley, William. "On the Statistics of Individual Variations of Productivity in Research Laboratories." Proceedings of the IRE (March 1957):279-290.
- Simosko, Vladimir and Smith, Maurice H. "An Evaluation of Serial Publications in the Aerospace Field." Sci-Tech News 25 (Spring 1971):5-9.
- Small, Henry G. Characteristics of Frequently Cited Papers in Chemistry. Philadelphia: Institute for Scientific Information, Final Report on Contract No. NSF-C795, September 1974.

- Small, Henry. "Co-Citation in the Scientific Literature: A New Measure of the Relationship Between Two Documents." Journal of the American Society for Information Science 24 (1973):265-269.
- Small, Henry, and Griffith, Belver C. The Structure of Scientific Literatures I: Identifying and Graphing Specialties. Philadelphia, Pa: Drexel University, 1975.
- Smith, David A. "The Ambiguity of Bradford's Law." (letter) Journal of Documentation 28 (September 1972):262.
- Solomon, Warren E. "Correlates of Prestige Ranking of Graduate Programs in Sociology." American Sociologist 7 (May 1972):13-14.
- Speigal-Rosing, I.S. "Journal Authors as an Indicator of Scientific Manpower; a Methodological Study Using Data for the Two Germanies and Europe." Science Studies 2 (1972):337-359.
- Stent, Gunther S. "Prematurity and Uniqueness in Scientific Discovery." Scientific American 227 (December 1972):84-93.
- Stevens, R.E. "Characteristics of Subject Literatures." Association of College and Reference Libraries Monograph Series No. 6 (1953): 10-12.
- Technology in Retrospect and Critical Events in Science. IIT Research Institute, December 15, 1968. Report Prepared for the National Science Foundation, Contract NSF-C535.
- Tolpin, J.G. et al. "The Scientific Literature Cited by Russian Organic Chemists." Journal of Chemical Education (May 1951): 254-258.
- Vickery, B.C. "Bradford's Law of Scattering." Journal of Documentation 4 (1948):198-203.
- Virgo, Julie. A Statistical Procedure for Evaluating the Importance of Scientific Papers. PhD Dissertation, University of Chicago, 1974.
- Weinberg, Alvin M. "Criteria for Scientific Choice." Minerva 1 (Winter 1963):159-171.
- Westbrook, J.H. "Identifying Significant Research." Science 132 (October 1960):1229-1234.
- Wilkinson, Elizabeth A. "The Ambiguity of Bradford's Law." Journal of Documentation 28 (June 1972):122-130.
- Wood, James L., Flanagan, Carolyn, and Kennedy, H. Edward. "Overlap Among the Journal Articles Selected for Coverage by BIOSIS, CAS, and EI." Journal of the American Society for Information Science 24 (January-February 1973):25-28.
- Wood, James L.; Flanagan, Carolyn; and Kennedy, H. Edward. "Overlap in the Lists of Journals Monitored by BIOSIS, CAS, and EI." Journal of the American Society for Information Science 23 (January-February 1972):36-38.

- Worthen, Dennis B. "The Application of Bradford's Law to Monographs" Journal of Documentation 31 (March 1975):19-25.
- Xhignesse, Louis V. and Osgood, Charles E. "Bibliographic Citation Characteristics of the Psychological Journal Network in 1950 and 1960." American Psychologist 22 (1967):778-791.
- Zuckerman, Harriet. "Nobel Laureates in Science: Patterns of Productivity, Collaboration, and Authorship." American Sociological Review 32 (June 1967):391-403.
- Zwolinski, Bruno, and Rossini, Frederick. "Analysis of References in Critical Tables." Science 130 (December 25, 1959):1743-1746.

B. Computer Horizons Reports and Articles Generated under
National Science Foundation Contract C627

First Annual Report. Exploration of the Possibility of Generating Importance and Utilization Measures by Citation Indexing of Approximately 250 Journals in the Physical Sciences. Contract NSF-C627 between National Science Foundation and Computer Horizons, Inc. August, 1971.

Phase I Report. Development of U.S. and International Indicators of the Quantity and Quality of Scientific Literature. Amendment No. 2, Contract NSF-C627 between National Science Foundation and Computer Horizons, Inc. December, 1971.

Second Annual Report. Exploration of the Possibility of Generating Importance and Utilization Measures by Citation Indexing of Approximately 500 Journals in the Physical Sciences. Contract NSF-C627 between National Science Foundation and Computer Horizons, Inc. August, 1972.

Supplement to Second Annual Report. Exploration of the Possibility of Generating Importance and Utilization Measures by Citation Indexing of Approximately 500 Journals in the Physical Sciences and Annotated Bibliography of International Publication and Citation Comparisons. Contract NSF-C627 between National Science Foundation and Computer Horizons, Inc. August, 1972.

Final Report. Development of U.S. and International Indicators of the Quality of Scientific Literature. Amendment No. 2, Contract NSF-C627 between National Science Foundation and Computer Horizons, Inc. September, 1972.

Third Annual Report. Evaluation of Research in the Physical Sciences Based on Publications and Citations. Contract NSF-C627 between National Science Foundation and Computer Horizons, Inc. November, 1973.

Final Report. Further Development of Indicators of the Quantity and Quality of the Scientific Literature. Amendment No. 4, Contract NSF-C627 between National Science Foundation and Computer Horizons, Inc. February 5, 1974.

Final Task Report for the period January 1, 1974 to December 31, 1974. Publications of BIOMES Scientists. Contract NSF-C627 between National Science Foundation and Computer Horizons, Inc. January 20, 1975.

Final Task Report for the period January 1, 1974 to December 31, 1974. Subject Classification and Influence Weights for 2,300 Journals. Contract NSF-C627 between National Science Foundation and Computer Horizons, Inc. June 30, 1975.

Carpenter, M. and Narin, Francis, "Clustering of Scientific Journals." Journal of the American Society for Information Science 24 (November-December 1973):425-436.

Narin, Francis; Carpenter, Mark; and Berlt, N.C. "Interrelationships of Scientific Journals." Journal of the American Society for Information Science 23 (September-October, 1972):323-331.

Narin, Francis and Carpenter, Mark. "National Publication and Citation Comparisons," Journal of the American Society for Information Science 26 (March-April, 1975):80-93.

Pinski, Gabriel and Narin, Francis, "Citation Influence for Journal Aggregates of Scientific Publication: Applications to the Literature of Physics." Submitted for publication.

C. Related Reports and Article: National Institutes
of Health Contract N01-OD-3-2109

Executive Summary for the period March 15, 1973 - June 14, 1974.

Evaluation of Linkage Between Research Publications and
NIH Funding. Contract N01-OD-3-2109 between National
Institutes of Health and Computer Horizons, Inc.
September 25, 1974.

Final Report for the period March 15, 1973 - June 14, 1974.

Evaluation of Linkage Between Research Publications and
NIH Funding. Contract N01-OD-3-2109 between National
Institutes of Health and Computer Horizons, Inc.
September 25, 1974.

Project Report. Structure of the Biomedical Literature.

A Sub-Task of Contract N01-OD-3-2109 between National
Institutes of Health and Computer Horizons, Inc.
November 25, 1975.

Narin, Francis; Pinski, Gabriel; and Gee, Helen Hofer.

"Structure of Biomedical Research Literature."
Journal of the American Society for Information Science
27 (January-February 1976):23-40.

GLOSSARY

This glossary is limited to evaluative bibliometric terminology. Some terms included in the glossary have meanings other than their bibliometric one; some terms not included in the glossary, particularly statistical and mathematical ones, have references in the text to explanatory papers or can be located in any standard dictionary.

AUTHOR COUNTRY (PUBLICATION) COUNT

The number of publications attributed to a country based on the address of the author's institution.

BIBLIOGRAPHIC COUPLING:

The referring, in common, by two documents to one or more previously published documents.
c.f. CO-CITATION

BIBLIOMETRICS:

The quantitative measurement of the properties of a literature, usually as an aid in exploring the production, distribution and utilization of its contents.

BIG SCIENCE:

The national role of science in the 1960's and 1970's characterized by large national expenditures of manpower and money. Big Science is distinguished from Little Science which is characterized as small scale, internally funded research in academic corners and basement workshops. See Price (1962). A critique of Price's techniques is contained in Gilbert and Woolger (1974).

BRADFORD CURVE:

The graphic representation of a Bradford distribution (see Bradford's Law): specifically a plot of the cumulated sum of articles on a given subject $[R(n)]$ on the ordinate versus the logarithm of the cumulated sum of the journals containing the articles $[\log n]$ on the abscissa.

BRADFORD'S LAW:

The empirically derived principle that if scientific journals are arranged in order of decreasing productivity of articles on a given subject, they may be divided into a nucleus of journals more particularly

devoted to the subject and several groups or zones of journals containing the same number of articles as the nucleus, where the number of periodicals in the nucleus and succeeding zones will be as $1:n:n^2:n^3\dots$. See Bradford (1948).

CITATION:

The acknowledgement that one bibliometric unit receives from another.

c.f. REFERENCE

CITATION ANALYSIS:

The evaluation and interpretation of the citations received by articles, scientists, universities, countries and other aggregates of scientific activity, used as a measure of scientific influence and productivity. Citation analysis is also used as a tool for measuring communication links in the sociology of science.

CITATION INDEX:

A structured list of all the citations to a given collection of publications, usually arranged so that each cited publication is followed by those publications which refer to it.

CITATION MATRIX:

The square array of citations received by each journal from itself and every other journal.

CLUSTER ANALYSIS:

A quantitative technique used in the analysis of multivariate data, to group objects according to their similarities. Used in bibliometrics to group journals into subject or national clusters, based on similarities in referencing patterns.

CO-CITATION:

The citation, in common, to two documents by one or more subsequent publications.

c.f. BIBLIOGRAPHIC COUPLING

CORE JOURNAL:

An important journal, central to a field or subfield, in which articles of high impact and influence frequently appear.

DOCUMENT COUPLING:

(See BIBLIOGRAPHIC COUPLING and CO-CITATION)

EVALUATIVE BIBLIOMETRICS:

The use of bibliometric techniques, especially publication and citation analyses, in the assessment of scientific activity. (See BIBLIOMETRICS)

FIELD:

A subject discipline (as physics) or an area of research (as drug abuse).

c.f. SUBFIELD

GROOS DROOP:

The levelling off of the Bradford curve at the point where the literature in a field is so widely dispersed that journals contain only one or two articles on the subject.

HIERARCHICAL MODEL:

A representation of the citation relationship between journals, fields or research levels, where for example, a level refers to the level below it more than it is cited by that level. For example,

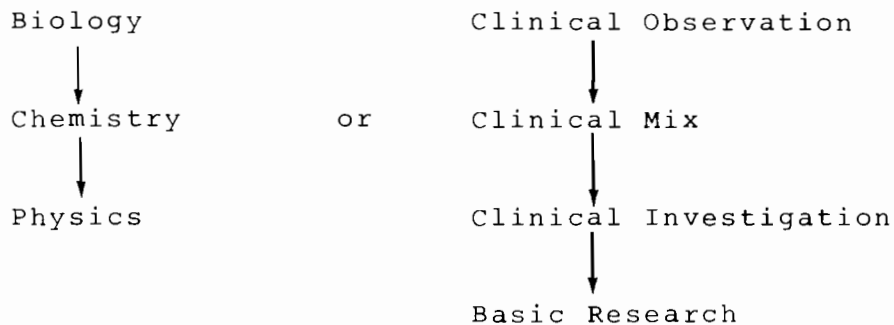

IMPACT FACTOR:

A normalized citation frequency measure, defined as the average number of citations received by articles published in a journal during a specified time period.

INFLUENCE WEIGHT:

A measure of journal importance derived by an iterative, normalized procedure in which a reference from a journal is weighted by the

influence of the referencing journals. The term "influence" as used here was developed without any knowledge of Cason and Lubotsky's almost identical use of the term in a paper published in 1936.

JOURNAL:

A recurring collection of articles (usually containing references), notes, reviews and other materials written by different authors reporting on research activity for purposes of professional communication.

JOURNAL COUNT:

The number of journals attributed to a country based on the country of publication of the journal.

JOURNAL SIZE:

A measure based on the number of articles, notes, and reviews contained in a journal. As a rough guideline, a large journal publishes over 400 articles per year, and a small journal publishes fewer than 50 articles per year.

KEYWORD:

A word or phrase used for indexing and other information retrieval purposes.

LEVEL:

See RESEARCH LEVEL

LOTKA'S LAW:

A principle of scientific productivity formulated by A.J. Lotka in 1926 stating that the number of authors who publish n papers in a given field is approximately $1/n^2$ times the number of authors who publish one paper only.

MULTI-DISCIPLINARY JOURNAL:

A journal containing articles pertaining to more than one field.

ORTEGA HYPOTHESIS:

The hypothesis that much of the growth of science can be attributed to the work of the average scientist who, with his small discoveries, paves the way for the men of genius. Cole and Cole (1972) use citation analysis to refute this hypothesis and suggest that only a few elite scientists make the majority of significant contributions which further scientific progress.

PROTOTYPE JOURNAL:

A journal serving as a type journal within a subject area or a research level: For example, the Journal of Biological Chemistry is the prototype journal for Level 4, basic biomedical research.

PUBLICATIONS:

Articles, notes, and/or reviews considered for bibliometric analysis. Letters, abstracts, book reviews, etc., are not generally used for such analysis.

REFERENCE:

The acknowledgement one unit gives to another.
c.f. CITATION

RESEARCH LEVEL:

A classification of journals by the type of research reported therein. For example, biomedical research journals are classified as:

- Level 1 - Clinical Observation
- Level 2 - Clinical Mix
- Level 3 - Clinical Investigation
- Level 4 - Basic Research

SERIAL:

A work issued in successive parts, usually at regular intervals, and, as a rule, intended to be continued indefinitely. Serials include journals, periodicals, annuals (reports, year books, etc.) and memoirs, proceedings, and transactions of societies.

SUBFIELD:

A component area of a field. For example, organic chemistry is a subfield of chemistry.
c.f. FIELD

TWO-STEP MODEL:

A map-like representation of the referencing between scientific journals constructed by tabulating all the references in the articles dealing with the area of interest, and then drawing an arrow from each journal to the two journals which it references first and second most frequently (other than for self-references).

UNIT:

A member of a set of publishing entities. These may, for example, be journals, institutions, individuals, fields of research, geographical subdivisions or levels of research methodology.

WEIGHTED JOURNAL (PUBLICATION) COUNT:

The number of publications attributed to a country based on the country of publication of the journal. Beware of international journals, especially from Holland.

APPENDIX I

JOURNAL LISTS, BY FIELD AND SUBFIELD, WITH INFLUENCE MEASURES

A-I. DATA SOURCES

The basic journal cross citing matrix was developed, after extensive refinement, from the citation tapes of the Science Citation Index.

The specific tapes used for this study were the citation tapes for 1973. These tapes contain 5,000,000 references from the 2,364 journals covered by the SCI in 1973, citing to an incredibly wide variety of different publications including journal papers, books, meetings, private communications, and so forth. While this is a comprehensive data source, it is also quite noisy due to the presence of the bewildering variety of cited journal names used by scientists.

As a result, a major unification was first carried out, in which all 5 million citations were sorted into cited publication order, and a list generated of the 16,000 cited publication names which appeared more than 20 times. Each of these cited names was individually checked and converted into the standard SCI abbreviation. This process included correcting for normal and erroneous variants of journal names, linking journals which had split or combined or changed names, and combining sections of journals where the cited sections could not be kept separate. After transformation a basic journal reference list was generated, which contained a journal by journal tabulation of all of the citations to and from each of the 2,364 journals on the tape.

The publication counts used for this study were counts of all articles, notes and reviews in each journal from the Corporate Tapes of the SCI in 1973, fully corrected for multiple authorship. The occasional article which appears without an author's organizational (corporate) affiliation would be omitted for this count. Counts of corporate index publications since 1965 indicate rather proportional growth rates, so that the use of 1973 publications as a size measure should not introduce any distortion into the influence weight computation.

A-II. COMPUTATIONAL CONSIDERATIONS

As explained in Section II, the actual computation of journal weights involves the repeated squaring of a matrix. We were limited to a maximum of an 88 x 88 matrix for this process. All the journals therefore cannot participate simultaneously in the weighting calculation on an individual basis. This problem was handled in the following way. As we have emphasized, the influence weight for any journal depends on the set of journals with which it is allowed to interact. Decisions of the type "with respect to which other journals do we wish a given journal to be evaluated?" must be made.

The biomedical fields are sufficiently interrelated that it is meaningful to talk of the weight of a journal "within biomedicine". Therefore, journals in clinical medicine and biomedical research were evaluated together. The biomedical grouping contains approximately 1,100 journals, still too much to work with in a single matrix. We can obtain a good approximation of the weights by breaking the calculation into smaller pieces. We consider individual journals in a few closely related subfields at a time, with the remaining biomedical journals grouped into several "pseudojournals". The idea is to let each journal interact on an individual basis with those with which it interacts most strongly. The remaining journals, grouped into pseudojournals, act with a common weight for each pseudojournal. As an example, one computer run involved the individual journals from general surgery and the surgical subspecialties along with the four large general medical journals, JAMA, NEJM, Lancet and Br Med J. The remaining biomedical journals were grouped into four pseudojournals, one for each research level. In this way, manipulations of a matrix larger than 88 x 88 were avoided in the weighting procedure.

The journals classified under biology were evaluated among themselves. The weight a journal received when classified as a biology journal is, of course, different from that which it would receive if classified under biomedicine. In some cases the distinction between the two categories is a close one.

Journals in psychology, chemistry, earth and space sciences, physics, and mathematics were also evaluated within their own fields. Chemical physics journals were evaluated in both chemistry and physics groupings| although only the weight within physics appears in the listings. The high weight of the large Journal of Chemical Physics with respect to the other chemistry journals has a significant effect, lowering the weight of the latter.

The citation data for engineering journals is not as good as the data for journals in the sciences. There are fewer references per publication, and of those a large percentage is to sources not covered by ISI such as trade journals and reports. Different areas of engineering are evaluated with respect to different groups of external fields. There follows a list of the various engineering subfields together with their evaluation groupings.

Chemical Engineering	with	individual applied chemical journals, subfields of chem. as pseudojournals
Metals	with	physics and chem. subfields as pseudojournals
Mechanical Engineering	with	physics and math subfields as pseudojournals
Civil Engineering		
Nuclear Engineering		
Aerospace Engineering		
Electrical Engineering	with	physics and math subfields as pseudojournals
Computers		
Library Information Science		
Operations Research Management Science/ Industrial Engineering General Engineering & Technology	with	physics, math and other engineering subfields as pseudojournals

The broad multidisciplinary journals were run simultaneously, along with pseudojournals for each of the major fields. The weights derived for multidisciplinary journals are thus weights within all science. They are composite weights for the journal as a whole and cannot be attributed to a component in a particular field. However, these weights appear in the journal listings under each category to which the journal is fractionally assigned, the same weight appearing each time. In addition, these journals were not even evaluated with respect to the same set of journals as the "pure" journals beside which they appear. This should serve as adequate caution in the interpretation of the weights for multidisciplinary journals.

A-III. INFLUENCE MEASURES FOR THE MAJOR FIELDS

In order to calculate influence measures for a field, individual journals belonging to the field are combined into a "pseudojournal" representing that field. The units which enter into the resulting 9 x 9 citation matrix are then the major fields themselves. The influence measures for the major fields appear in Table A-1.

The hierarchy for influence flow among the basic sciences

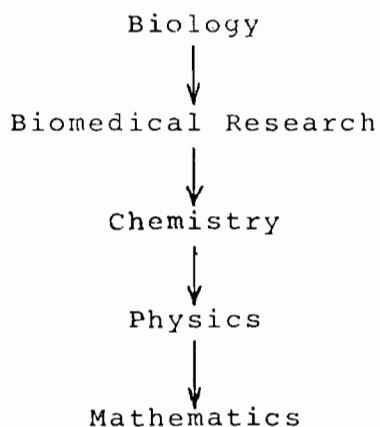

is contained in the influence weights rather than in the influence per publication or in the total influence. Mathematics has a higher influence weight than physics although it has a lower influence per publication and a lower total influence.

TABLE A-1

INFLUENCE MEASURES FOR THE MAJOR FIELDS

	<u>INFL</u> <u>WT</u>	<u>REFS/</u> <u>PUB</u>	<u>INFL/</u> <u>PUB</u>	<u>PUBS</u>	<u>TOTAL</u> <u>INFL</u>
CLINICAL MEDICINE	0.59	13.2	7.8	45759	358832
BIOMEDICAL RESEARCH	0.84	17.8	15.0	61142	915487
BIOLOGY	0.47	10.1	4.7	22186	104564
CHEMISTRY	1.05	13.9	14.6	42115	615375
PHYSICS	2.10	12.6	26.4	33134	873828
EARTH & SPACE SCIENCE	0.98	12.1	11.8	9814	115582
ENGINEERING & TECHNOLOGY	0.93	6.0	5.6	27404	153379
PSYCHOLOGY	0.62	9.9	6.1	6777	41314
MATHEMATICS	2.98	5.3	15.7	7242	113381

A-IV. INFLUENCE MEASURES FOR THE SUBFIELDS

Individual journals belonging to a subfield can be combined into a pseudojournal representing that subfield. The units which enter into the citation matrix are then the subfields themselves.

Two sets of influence measures have been derived for each of the subfields: measures for each subfield within all science and within its own field. The subfields within clinical medicine and within biomedical research are considered together so that all subfields of biomedicine have a common normalization. There was a separate calculation for the subfields of each of the other seven major fields. The listing of influence measures for all subfields appears in Table A-2.

The approximately 100 subfields into which science was subdivided were too numerous for a single computer run of the matrix algorithm. The following procedure was therefore employed: biomedicine was separated into five parts, which were then run with all subfields from the other seven major fields: biochemistry, physiology, pharmacy, clinical medicine and the remaining biomedical research. Pharmacy was treated separately because of its role both as a subfield of biomedicine and as an applied branch of chemistry. Biochemistry and physiology, the basic source fields within biomedicine, were singled out so that their weights, calculated within all science, could be used to rescale the remaining subfields of biomedicine. The influence weights for these two within all science is 1.17 while their influence within biomedicine is 1.69. The ratio, $1.17/1.69 = 0.69$, is used to rescale the biomedical subfield weights so that they are commensurable with subfield weights for the rest of science. This procedure was used for all biomedical weights except for pharmacy whose weight within science was calculated directly.

It must be remembered that a subfield measure applies to the group of journals which has been assigned to that subfield; due to the problem of general journals in a field, discussed in Section III-D, these measures do not necessarily provide a good representation of the subfield of research represented by that journal subfield. For example, most nuclear physics publications appear in journals classified under general physics. At present, subfield measures for nuclear and for solid state physics are not useful.

As citations to journal sections become more precise and as a higher percentage of citations are to years since such sections were established, influence measures for the subfields will become meaningful.

TABLE A-2

INFLUENCE MEASURES FOR THE SUBFIELDS

	INFL WT		REFS/PUB		INFL/PUB		PUBS		TOTAL INFL	
	Within	Within	Within	Within	Within	Within	Within	Within	Within	Within
	All Science	Biomedicine	All Science	Biomedicine	All Science	Biomedicine	All Science	Biomedicine	All Science	Biomedicine
CLINICAL MEDICINE										
GENERAL & INTERNAL MED (LEVEL 1)	0.37	.54	13.2	4.9	7.1	7719	37574	54455		
GENERAL & INTERNAL MED (LEVEL 2)	0.71	1.03	21.2	15.0	21.7	3628	54357	78778		
GENERAL & INTERNAL MED (LEVEL 3)	0.79	1.15	15.7	12.4	18.0	4120	51204	74208		
ALLERGY	0.38	.55	15.3	5.8	8.5	425	2479	3593		
ANESTHESIOLOGY	0.23	.33	14.4	3.2	4.7	914	2968	4302		
CANCER	0.52	.76	18.3	9.6	13.9	2607	24988	36215		
CARDIOVASCULAR SYSTEM	0.59	.86	18.8	11.1	16.1	2459	27351	39639		
DENTISTRY	0.23	.33	9.8	2.2	3.2	1809	3980	5768		
DERMATOLOGY & VENEREAL DISEASES	0.31	.45	13.7	4.3	6.2	1303	5537	8024		
ENDOCRINOLOGY	0.73	1.06	18.3	13.4	19.4	2702	36084	52296		
FERTILITY	0.35	.50	14.9	5.2	7.5	705	3643	5279		
GASTROENTEROLOGY	0.36	.52	19.1	6.8	9.9	1185	8086	11719		
GERIATRICS	0.22	.32	11.0	2.4	3.5	511	1245	1805		
HEMATOLOGY	0.58	.85	17.3	10.1	14.7	1112	11263	16323		
IMMUNOLOGY	0.65	.95	17.4	11.4	16.5	3847	43720	63362		
OBSTETRICS & GYNECOLOGY	0.37	.53	12.8	4.7	6.9	1502	7101	10291		
NEUROLOGY & NEUROSURGERY	0.47	.68	18.1	8.5	12.3	4263	36120	52348		
OPHTHALMOLOGY	0.30	.43	11.8	3.5	5.1	1785	6275	9094		
ORTHOPEDICS	0.39	.56	10.2	3.9	5.7	1009	3981	5769		
ARTHRITIS & RHEUMATISM	0.46	.67	15.4	7.1	10.3	315	2237	3242		
OTORHINOLARYNGOLOGY	0.24	.35	11.0	2.7	3.9	980	2600	3768		
PATHOLOGY	0.52	.75	17.5	9.1	13.2	2163	19639	28463		
PEDIATRICS	0.40	.59	15.1	6.1	8.8	2230	13606	15719		
PHARMACOLOGY	0.44	.63	16.1	7.0	10.2	5715	40017	57996		
PHARMACY	0.28	.22	11.9	3.4	2.7	3143	10644	8407		
PSYCHIATRY	0.50	.73	9.9	5.0	7.2	1518	7522	10901		
RADIOLOGY & NUCLEAR MEDICINE	0.38	.55	10.9	4.2	6.0	3325	13848	20069		
RESPIRATORY SYSTEM	0.33	.48	13.8	4.6	6.6	875	4003	5802		
SURGERY	0.45	.65	11.3	5.1	7.4	4414	22512	32626		
TROPICAL MEDICINE	0.51	.74	11.3	5.8	8.4	478	2766	4009		
UROLOGY	0.34	.49	9.6	3.2	4.7	926	2998	4345		
NEPHROLOGY	0.11	.17	24.3	2.8	4.0	189	524	759		
VETERINARY MEDICINE	0.19	.28	10.5	2.0	2.9	2232	4486	6501		
HYGIENE & PUBLIC HEALTH	0.59	.86	8.6	5.1	7.3	1658	8403	12178		
MISCELLANEOUS CLINICAL MEDICINE	0.19	.28	10.7	2.1	3.0	351	725	1051		

TABLE A-2

INFLUENCE MEASURES FOR THE SUBFIELDS (Continued)

	INFL WT		REFS/PUB		INFL/PUB		PUBS		TOTAL INFL	
	Within All Science	Within Biomedicine	Within All Science	Within Biomedicine	Within All Science	Within Biomedicine	Within All Science	Within Biomedicine	Within All Science	Within Biomedicine
BIOMEDICAL RESEARCH										
PHYSIOLOGY	1.17	1.69	23.5	27.4	39.8	2455	67380	97652		
ANATOMY, MORPHOLOGY & EMBRYOLOGY	0.61	.89	20.3	12.4	18.0	1214	15071	21843		
GENETICS & HEREDITY	0.49	.71	15.7	7.7	11.2	2600	20083	29106		
NUTRITION & DIETETICS	0.29	.42	17.7	5.1	7.4	1019	5187	7517		
BIOCHEMISTRY, MOLECULAR BIOLOGY & BIOPHYSICS	1.17	1.69	20.7	24.0	34.8	13318	319793	463353		
CELL BIOLOGY, CYTOLOGY & HISTOLOGY	0.81	1.17	21.7	17.5	12.3	3156	55256	80095		
MICROBIOLOGY	0.52	.75	16.5	8.5	25.4	3108	26434	38311		
VIROLOGY	0.63	.91	17.8	11.3	16.3	1406	15824	22933		
PARASITOLOGY	0.41	.59	10.9	4.4	6.4	916	4054	5876		
BIOMEDICAL ENGINEERING	0.30	.41	8.3	2.5	3.4	890	2213	1984		
MICROSCOPY	0.42	.61	12.9	5.4	7.9	164	1980	2870		
MISCELLANEOUS BIOMEDICAL RESEARCH	0.26	.37	7.8	2.0	2.9	1082	2146	3110		
GENERAL BIOMEDICAL RESEARCH	0.92	1.34	13.9	12.9	18.7	1603	20626	29893		
BIOLOGY										
GENERAL BIOLOGY	0.64	1.47	12.1	7.7	17.8	290	2244	5151		
GENERAL & MISCELLANEOUS ZOOLOGY	0.39	.96	13.1	5.1	12.6	2526	12849	31800		
ENTOMOLOGY	0.37	.94	8.2	3.0	7.7	2036	6119	15710		
MARINE BIOLOGY & HYDROBIOLOGY	0.38	.74	9.6	3.6	7.1	1402	5061	9933		
BOTANY	0.42	1.20	12.2	5.1	14.6	5747	29363	83925		
ECOLOGY	0.49	1.02	10.8	5.3	11.0	996	5286	10961		
AGRICULTURE & FOOD SCIENCE	0.31	.83	8.5	2.6	7.1	6253	16355	44168		
DAIRY & ANIMAL SCIENCE	0.35	.97	10.2	3.6	9.9	1701	6061	16864		
MISCELLANEOUS BIOLOGY	0.31	.86	11.1	3.4	9.5	478	1638	4547		

TABLE A-2
INFLUENCE MEASURES FOR THE SUBFIELDS (Continued)

	INFL WT		REFS/PUB		INFL/PUB		PUBS		TOTAL INFL	
	Within All Science	Within Chemistry	Within All Science	Within Chemistry	Within All Science	Within Chemistry	Within All Science	Within Chemistry	Within All Science	Within Chemistry
CHEMISTRY										
ANALYTICAL CHEMISTRY	0.85	.87	11.6	10.0	9.9	10.0	3852	37950	38696	
ORGANIC CHEMISTRY	0.66	.64	14.2	9.0	9.4	9.0	5968	56301	53983	
INORGANIC & NUCLEAR CHEMISTRY	0.86	.78	14.5	11.4	12.4	11.4	2515	31295	28554	
APPLIED CHEMISTRY	0.85	1.01	12.2	12.3	10.4	12.3	2762	28677	34101	
GENERAL CHEMISTRY	1.15	1.16	15.7	18.2	18.0	18.2	16089	289657	293012	
POLYMERS	0.63	.63	11.4	7.2	7.1	7.2	3224	22923	23228	
PHYSICAL CHEMISTRY	1.36	1.31	12.5	16.4	17.0	16.4	7579	128548	124485	
	Within All Science	Within Physics	Within All Science	Within Physics	Within All Science	Within Physics	Within All Science	Within All Science	Within All Science	Within Physics
PHYSICS										
CHEMICAL PHYSICS	2.84	.93	15.7	14.6	44.5	14.6	3220	143464	46965	
SOLID STATE PHYSICS	1.20	.48	11.1	5.4	13.2	5.4	3909	51635	21001	
FLUIDS & PLASMAS	2.55	1.03	10.4	10.7	26.4	10.7	888	23473	9531	
APPLIED PHYSICS	1.78	.75	8.6	6.5	15.2	6.5	6188	94033	40125	
ACOUSTICS	1.18	.76	8.3	6.3	9.8	6.3	989	9682	6247	
OPTICS	1.94	.84	12.7	10.6	24.7	10.6	1180	29148	12543	
GENERAL PHYSICS	3.04	1.22	13.5	16.4	41.0	16.4	14786	606944	243126	
NUCLEAR & PARTICLE PHYSICS	2.00	.81	23.9	19.4	47.7	19.4	1273	60722	24735	
MISCELLANEOUS PHYSICS	2.67	1.10	9.3	10.2	24.7	10.2	611	15115	6262	

TABLE A-2

INFLUENCE MEASURES FOR THE SUBFIELDS (Continued)

	INFL WT		REFS/PUB		INFL/PUB		PUBS		TOTAL INFL	
	Within	Space Science	Within	Space Science	Within	Space Science	Within	Space Science	Within	Space Science
	All Science	Engineering	All Science	Engineering	All Science	Engineering	All Science	Engineering	All Science	Engineering
EARTH & SPACE SCIENCE										
ASTRONOMY & ASTROPHYSICS	1.42	.88	14.0	19.9	12.3	12.3	3113	62118	38134	
METEOROLOGY & ATMOSPHERIC SCIENCE	1.16	1.25	9.0	10.4	11.3	11.3	571	5956	6434	
GEOLOGY	1.01	1.09	11.1	11.2	12.1	12.1	1820	20387	22081	
EARTH & PLANETARY SCIENCE	1.02	1.05	12.4	12.6	13.0	13.0	3580	45126	46523	
OCEANOGRAPHY & LIMNOLOGY	0.68	1.15	9.1	6.1	10.5	10.5	536	3283	5619	
	Within	Engineering	Within	Engineering	Within	Engineering	Within	Engineering	Within	Engineering
	All Science	Engineering	All Science	Engineering	All Science	Engineering	All Science	Engineering	All Science	Engineering
ENGINEERING & TECHNOLOGY										
CHEMICAL ENGINEERING	0.85	.92	6.3	5.4	5.8	5.8	2454	13179	14223	
MECHANICAL ENGINEERING	0.76	.68	5.3	4.0	3.6	3.6	2518	10064	9035	
CIVIL ENGINEERING	0.26	.45	7.6	2.0	3.4	3.4	799	1600	2727	
ELECTRICAL ENGINEERING & ELECTRONICS	1.22	.84	6.6	8.0	5.5	5.5	5797	46680	32139	
MISCELLANEOUS ENGINEERING & TECHNOLOGY	0.76	.81	3.7	2.8	3.0	3.0	1155	3253	3440	
METALS & METALLURGY	1.11	1.67	7.9	8.7	13.2	13.2	4570	39934	60436	
MATERIALS SCIENCE	0.69	.60	6.8	4.7	4.1	4.1	2306	10853	9424	
NUCLEAR TECHNOLOGY	0.63	.52	7.8	4.9	4.1	4.1	1712	8446	6944	
AEROSPACE TECHNOLOGY	1.84	1.09	3.6	6.7	3.9	3.9	1009	6735	3959	
COMPUTERS	1.62	1.15	5.9	9.6	6.8	6.8	1177	11249	76590	
LIBRARY & INFORMATION SCIENCE	0.49	.72	4.2	2.0	3.0	3.0	462	947	1393	
OPERATIONS RESEARCH & INDUSTRIAL ENGINEERING	1.26	1.78	3.7	4.6	6.6	6.6	341	1581	2251	

TABLE A-2

INFLUENCE MEASURES FOR THE SUBFIELDS (Continued)

	<u>INFL WT</u>		<u>REFS/PUB</u>		<u>INFL/PUB</u>		<u>PUBS</u>		<u>TOTAL INFL</u>	
	<u>All Science</u>	<u>Within Psychology</u>	<u>All Science</u>	<u>Within Psychology</u>	<u>All Science</u>	<u>Within Psychology</u>	<u>All Science</u>	<u>Within Psychology</u>	<u>All Science</u>	<u>Within Psychology</u>
<u>PSYCHOLOGY</u>										
CLINICAL PSYCHOLOGY	0.95	1.92	7.3	14.0	6.9	14.0	554	3810	7753	
PERSONALITY & SOCIAL PSYCHOLOGY	0.55	.97	7.9	7.7	4.4	7.7	785	3414	6015	
DEVELOPMENTAL & CHILD PSYCHOLOGY	0.47	.84	10.2	8.5	4.8	8.5	342	1624	2923	
EXPERIMENTAL PSYCHOLOGY	0.68	1.27	9.8	12.5	6.7	12.5	1614	10807	20119	
GENERAL PSYCHOLOGY	0.52	.92	11.1	10.2	5.8	10.2	1544	8943	15716	
MISCELLANEOUS PSYCHOLOGY	0.43	.76	7.3	5.6	3.1	5.6	637	2001	3553	
BEHAVIORAL SCIENCE	0.30	.57	12.2	6.9	3.7	6.9	1252	4582	8676	
	<u>Within All Science</u>	<u>Within Psychology</u>	<u>Within All Science</u>	<u>Within Psychology</u>	<u>Within All Science</u>	<u>Within Psychology</u>	<u>Within All Science</u>	<u>Within Psychology</u>	<u>Within All Science</u>	<u>Within Psychology</u>
	3.12	.64	5.7	3.6	17.7	3.6	1207	21311	4403	
<u>MATHEMATICS</u>										
PROBABILITY & STATISTICS	3.04	.84	5.6	4.7	17.1	4.7	1360	23223	6367	
APPLIED MATHEMATICS	5.08	1.16	5.1	5.9	25.6	5.9	4293	110118	25463	
GENERAL MATHEMATICS	3.63	.84	5.4	4.5	19.6	4.5	322	6311	1461	
MISCELLANEOUS MATHEMATICS										

A-V. INFLUENCE MEASURES FOR JOURNALS

Table A-3 contains the listing of influence measures for all journals for which enough citation and publication data were available to provide reliable results.

In order for a journal to participate in the weighting scheme, its citation data had to be judged adequate. In most fields, 100 references from and 20 cites to a journal was the minimum requirement. In fields where there tended to be less citing, such as the engineering fields, the requirement was lowered to 50 references from and 10 cites to a journal. Journals for which there was inadequate data appear in the listings without weights.

There were some cases where, because of similarity between journal names, it was impossible to unambiguously identify citations. Examples of this are Journal of Microscopy-Oxford (J Microsc O) and Journal de Microscopie-Paris (J Microscop). While some citations were easily identified others, to variants such as J Microsc, were impossible to assign.

Another such pair is

Zeitschrift fur Physikalische Chemie, Frankfurt
(Z Phys Ch F)

and

Zeitschrift fur Physikalische Chemie, Leipzig
(Z Phys Ch L)

The bulk of citations here are to the variants Z Phys Chem and Z Physik Chem and so cannot be assigned to one or the other.

As an alternative to eliminating both journals of such a pair from the analysis, it was decided to combine them into an undifferentiated form representing their combination. It is only the constructed combination which receives a weight.

Measures for journals which received split field assignments, such as the multidisciplinary journals, appear in brackets, with the percentage for that field appearing in parentheses before the influence weight.

It is essential that the context within which a journal is being evaluated is made clear. There are three levels in the classification hierarchy (as opposed to the use of the term levels for the biomedical research levels) at which one can discuss a journal: within all science, within its field and within its subfield. Except for the multidisciplinary journals the matrix calculations for journals were performed at the field level, that is, the journal influence weights, appearing in Table A-3 are weights within the major field. One might also wish to evaluate a journal within its own subfield. To consider the matrix of citations within the subfield alone would eliminate all interactions outside of that subfield. It was decided that the influence weight of a journal should be determined not only by its interactions within its own subfield, especially in view of classification problems at the subfield level, but by all its interactions within its field. Nevertheless a measure having absolute meaning at the subfield level should be available. Such a measure can be obtained by dividing the journal weight calculated within its field by the weight of its subfield calculated within its field. It is for this reason, that the influence weights for each subfield within its field are given in Table A-2.

An example of this procedure should serve to clarify it. In Table A-3, page A-53, the influence weight of the Journal of the Acoustical Society of America is given as 1.50. This is its weight within all of physics. In Table A-2, we find that the weight of the subfield acoustics within physics is 0.76. The weight of this journal within its own subfield is then $\frac{1.50}{.76} = 1.97$. This calculation should only be performed for journals in relatively self contained subfields.

A-VI. JOURNAL COVERAGE

A large majority of the significant scientific journals are covered by ISI. There are however, a number of omissions, which when contrasted with some of the journals which have been covered by ISI cause one to wonder at the selection criteria. The British Journal of Urology, one of the two most cited urology journals, with more than 1,000 cites from journals covered by ISI in 1973, is omitted. The Journal of Laryngology and Otology, with over 700 cites, is also omitted. On the other hand, ISI has covered such publications as Gleanings in Bee Culture, Dock and Harbor Authority, Pipeline and Gas Journal and Lubrication from which negligible citation data are obtained; coverage of the first two of these was discontinued in 1972.

Note on fractionally assigned journals:

Journals which were assigned to more than one field or subfield are listed in the table with the percentage for each fractional assignment appearing in parentheses. The influence weight, influence per publication, and total influence appear in square brackets indicating that these measures do not apply to one field or subfield alone but represent an average over those categories to which the journal has been assigned.

TABLE A-3

JOURNAL ASSIGNMENTS & INFLUENCE MEASURES (1973 DATA)
31-JAN-75

	INFL WT	REFS /PUB	INFL /PUB	PUBS	TOT INFL
CLINICAL MEDICINE					
GENERAL AND INTERNAL MEDICINE					
ACT MED H (L2)*	0.11	17.7	2.0	41	82
ACT MED OKA (L3)	0.12	15.2	1.9	34	64
ACT MED SC (L2)	0.56	24.4	13.7	242	3316
ACT U CAR M (L2)	0.02	84.4	1.7	19	32
AM FAM PHYS (L1)		0.1		99	
AM J MED (L2)	1.43	30.7	44.0	185	8134
AM J MED SC (L2)	1.07	18.8	20.0	119	2386
ANN BIOL CL (L3)	0.15	14.3	2.1	81	173
ANN CLIN R (L2)	0.19	19.4	3.7	40	146
ANN INT MED (L1)	1.55	26.5	41.0	198	8126
ANN MED EXP (L3)	1.50	17.0	25.5	20	510
ANN R MED (L3)	0.31	64.2	20.1	34	685
ARCH BIOL M (L3)		0.0		0	
ARCH IN MED (L2)	0.83	25.4	21.2	221	4673
ARCH INV M (L2)	0.02	9.5	0.2	52	9
AUST J EX B (L3)	0.80	18.3	14.7	86	1262
AUST NZ J M (L1)	0.30	21.1	6.3	70	442
B EX BIO R (L3)	0.19	6.8	1.2	529	661
B NY AC MED (L2)	0.95	6.0	5.7	87	499
B S SCI MED (L2)		10.2		6	
B SC AK MED (L2)	0.23	12.1	2.8	22	62
BIOCHEM MED (L3)	0.28	14.9	4.2	104	442
BIOMED EXFR (L2)		13.1		66	
BIOMEDICINE (L3)		21.6		122	
BR MED B (L3)	0.71	39.7	28.2	47	1324
BR MED J (L1)	1.39	17.7	24.7	608	15042
CALIF MED (L1)	0.12	19.6	2.4	158	378
CAN MED A J (L1)	0.73	14.2	10.4	214	2223
CLIN BIOCH (L3)	0.51	11.2	5.8	34	196
CLIN CHEM (L3)	0.60	15.4	9.2	262	2418
CLIN CHIM A (L3)	0.77	12.0	9.2	454	4186
CLIN MED (L1)	0.16	12.1	2.0	40	78
CLIN SC MOL (L3)	1.21	19.2	23.3	146	3397
DAN MED B (L2)	0.31	19.9	6.1	40	243
DEUT MED WO (L1)	0.27	15.5	4.2	534	2227
ENDOSCOPY (L1)	0.35	5.8	2.0	46	94
EUR J CL IN (L3)	0.45	27.1	12.2	48	584
HELV MED A (L2)	0.46	7.7	3.5	60	211
HIRS J MED (L2)		11.0		9	
I J MED RES (L2)	0.31	8.7	1.8	295	531
INTERNIST (L1)	0.10	15.9	1.5	100	154
IRISH J MED (L2)	0.18	12.4	2.2	55	124
ISR J MED S (L2)		0.0		0	
J ALB EIN M (L1)		9.3		7	
J AM MED A (L1)	2.07	15.0	30.9	421	13022
J CHRON DIS (L1)	0.92	22.1	20.4	47	956
J CLIN INV (L3)	2.41	26.8	64.6	366	23788
J IRISH C P (L1)		7.9		22	

*Level Indicator: (L1)=Level 1, (L2)=Level 2, etc. See III-C-2.

JOURNAL ASSIGNMENTS & INFLUENCE MEASURES (1973 DATA)
31-JAN-75

	INFL WT	REFS /PUB	INFL /PUB	PUBS	TOT INFL
CLINICAL MEDICINE (CONTINUED)					
GENERAL AND INTERNAL MEDICINE (CONTINUED)					
J IRISH MED (L1)	0.04	6.6	0.2	102	24.
J LA CL MED (L3)	1.84	21.7	39.9	206	8215.
J MED (L3)		0.0		0	
JAP J MED S (L2)	0.85	11.3	9.6	30	287.
JOHNS H MED (L2)	1.50	15.2	22.7	65	1479.
KLIN WOCH (L2)	0.53	22.7	11.9	209	2495.
LANCET (L2)	1.80	28.0	50.4	603	30415.
LILLE MED (L1)	0.05	14.8	0.8	113	86.
LYON MED (L2)	0.10	12.3	1.2	180	225.
MAYO CLIN P (L2)	0.75	15.3	11.4	106	1207.
MED C VIRG (L1)		5.1		73	
MED CLIN NA (L1)	0.18	38.6	6.9	113	783.
MED J AUST (L1)	0.32	11.1	3.5	502	1772.
MEDICINA (L2)	0.05	22.1	1.0	66	65.
MEDICINE (L2)	0.93	48.7	45.2	38	1719.
MEM I OSW C (L3)	0.22	12.6	2.7	13	35.
MILIT MED (L1)	0.82	6.1	5.0	92	458.
MT SINAI J (L2)	0.19	17.7	3.3	77	253.
N ENG J MED (L2)	1.78	26.4	46.8	438	20520.
NOUW PRESSE (L1)	0.37	10.4	3.8	427	1635.
NY ST J MED (L1)	0.22	12.3	2.7	247	674.
NZ MED J (L1)	0.26	8.9	2.3	100	229.
P R VIRCH M (L2)		0.0		0	
P ROY S MED (L1)	0.78	6.1	4.7	427	2015.
P SOC EXP M (L3)	1.56	13.4	20.8	866	18047.
P U OTAGO M (L2)	0.51	4.8	2.5	34	84.
PERSP BIOL (L3)	0.43	17.7	7.6	41	313.
POSTG MED J (L1)	0.26	13.7	3.6	247	892.
POSTGR MED (L1)	0.17	10.6	1.8	183	337.
PRACTITION (L1)	0.25	8.1	2.0	176	354.
Q J MED (L2)	1.02	31.3	32.0	47	1502.
RES EXP MED (L3)	0.32	15.4	4.9	97	477.
REV INF MED (L1)		2.2		19	
REV INV CLI (L2)	0.02	17.3	0.3	46	14.
REV MED CHI (L2)	0.01	9.8	0.1	166	17.
S AFR MED J (L1)	0.12	11.3	1.3	491	653.
SB LEKAR (L3)	0.05	13.0	0.7	51	36.
SC J CL INV (L3)	1.07	18.3	19.5	171	3331.
SCHW MED WO (L1)	0.26	14.7	3.8	349	1330.
SCOT MED J (L1)	0.41	25.5	10.6	31	327.
SEM HOP PAR (L1)	0.09	12.6	1.2	381	442.
SOUTH MED J (L1)	0.21	11.4	2.4	277	670.
SOV MED (L1)	0.03	4.9	0.1	467	65.
TEX REP BIO (L3)	1.07	19.6	21.0	27	567.
TOH J EX NE (L3)	0.32	12.1	3.9	134	517.
UN MED CAN (L2)	0.03	14.8	0.5	249	122.
UPSAL J MED (L3)	0.34	14.9	5.1	49	248.
WIEN KLIN W (L1)	0.17	12.6	2.1	225	470.
YALE J BIOL (L3)	2.27	16.8	38.2	17	649.

JOURNAL ASSIGNMENTS & INFLUENCE MEASURES (1973 DATA)
31-JAN-75

	INFL WT	REFS /PUB	INFL /PUB	PUBS	TOT INFL
CLINICAL MEDICINE (CONTINUED)					
GENERAL AND INTERNAL MEDICINE (CONTINUED)					
YON ACT MED (L3)	0.05	13.8	0.6	35	22.
Z KLIN CHEM (L3)	0.34	15.5	5.3	91	488.
ALLERGY					
ACT ALLERG (L1)	0.42	11.8	4.9	40	197.
ANN ALLERGY (L1)	0.26	15.7	4.0	59	238.
INT A ALLER (L3)	0.64	15.4	9.9	226	2242.
J ALLERG CL (L2)	0.89	16.8	15.0	72	1078.
PROG ALLERG (L3)		0.0		0	
REV FR ALLE (L1)	0.03	14.3	0.5	28	13.
ANESTHESIOLOGY					
ACT ANAE SC (L2)	0.26	15.4	4.0	43	172.
ANAESTHESIA (L1)	0.26	10.1	2.6	115	302.
ANAESTHESIS (L2)	0.08	15.0	1.1	106	119.
ANESTH AN R (L2)	0.02	16.7	0.4	50	19.
ANESTH ANAL (L2)	0.27	10.5	2.8	170	478.
ANESTHESIOL (L2)	0.66	16.8	11.0	176	1941.
BR J ANAEST (L2)	0.35	16.4	5.7	177	1009.
CAN ANAE SJ (L2)	0.19	16.5	3.2	77	246.
CANCER					
ARCH GESCHW (L3)	0.10	19.1	2.0	58	114.
B CANCER (L3)	0.35	28.3	10.0	13	130.
BR J CANC (L2)	0.65	16.6	10.8	156	1682.
CANC CHEMOT (L3)	0.58	11.2	6.5	185	1201.
CANCER (L2)	0.83	17.3	14.4	436	6261.
CANCER RES (L3)	1.09	21.8	23.0	498	11847.
EUR J CANC (L3)	0.51	17.1	8.7	96	832.
GANN (L3)	0.47	13.2	6.2	101	628.
INT J CANC (L3)	0.83	23.2	19.2	156	2998.
J NAT CANC (L3)	0.96	16.9	18.1	457	8281.
NAT CAN I M (L3)	0.09	20.3	1.9	143	275.
NEOPLASMA (L3)	0.12	14.6	1.7	110	187.
ONCOLOGY (L2)	0.11	20.7	2.3	73	166.
P AM ASS CA (L3)		0.0		0	
PROG EX TUM (L3)		0.0		0	
TUMORI (L2)	0.13	16.7	2.2	43	95.
Z KREBSF KL (L3)	0.53	13.6	7.2	82	586.
CARDIOVASCULAR SYSTEM					
AM HEART J (L2)	1.18	18.0	21.2	229	4862.
AM J CARD (L2)	0.88	22.7	19.9	258	5137.
ANGIOLOGICA (L4)	0.28	13.9	3.9	45	177.
ANGIOLOGY (L2)	0.39	14.0	5.4	77	417.
ANN CARD AN (L1)	0.03	18.1	0.5	54	25.
ARCH KREISL (L2)	0.44	116.0	51.3	2	102.
ARCH MAL C (L1)	0.14	14.0	2.0	148	300.
ATHEROSCLER (L3)	0.67	19.3	13.0	89	1154.

JOURNAL ASSIGNMENTS & INFLUENCE MEASURES (1973 DATA)
31-JAN-75

	INFL WT	REFS /PUB	INFL /PUB	PUBS	TOT INFL
CLINICAL MEDICINE (CONTINUED)					
CARDIOVASCULAR SYSTEM (CONTINUED)					
BAS R CARD (L3)		0.0		0	
BIBL CARDIO (L2)		0.0		0	
BR HEART J (L1)	0.76	15.1	11.5	213	2447.
CARDIO RES (L3)	0.44	15.5	6.8	114	775.
CARDIOLOGIA (L3)	0.48	21.4	10.3	28	290.
CHEST (L1) (80N) [0.30]		12.8	[3.8]	404	[1541.]
CIRCUL RES (L3)	1.92	25.6	49.2	192	9443.
CIRCULATION (L2)	1.53	24.3	37.1	317	11754.
COEUR MED I (L2)	0.06	14.2	0.9	63	55.
HERZ KREISL (L1)	0.02	10.9	0.2	71	16.
J ELCARDIOL (L2)	0.16	11.6	1.9	69	130.
J MOL CEL C (L4)	0.25	25.9	6.5	51	330.
JAP CIRC J (L2)	0.14	18.4	2.5	116	295.
JAP HEART J (L2)	0.27	12.2	3.3	72	236.
LYMPHOLOGY (L3)	0.38	10.5	4.0	24	97.
MICROVASC R (L4)	0.34	13.3	4.5	82	372.
Z KREISLAUF (L2)	0.09	21.6	1.9	145	270.
DENTISTRY					
ACT ODON SC (L2)	0.42	14.3	6.0	39	232.
AM J ORTHOD (L2)	0.37	5.6	2.1	146	301.
ANGL ORTHOD (L2)	0.29	16.7	4.9	30	146.
ARCH ORAL B (L3)	0.44	15.6	6.6	161	1101.
BR DENT J (L2)	0.46	7.3	3.3	134	449.
CARIES RES (L3)	0.35	13.5	4.7	36	171.
DENT CLIN N (L1)	0.24	4.1	1.0	56	55.
HELV ODON A (L2)	0.41	15.6	6.4	12	77.
INT DENT J (L3)	0.09	12.5	1.2	49	58.
J AM DENT A (L1)	0.58	8.2	4.8	134	645.
J BIOL BUCC (L3)		14.2		21	
J DENT RES (L3)	0.70	7.9	5.5	247	1358.
J ORAL SURG (L1)	0.19	7.9	1.5	154	231.
J PERIOD RE (L3)	0.13	17.0	2.2	57	125.
J PERIODONT (L2)	0.22	13.5	3.0	105	320.
J PROD DENT (L1)	0.24	6.4	1.5	161	248.
ORAL SURG D (L2)	0.29	9.8	2.9	230	660.
SC J DENT R (L3)	0.07	14.6	1.0	58	56.
DERMATOLOGY & VENEREAL DISEASES					
ACT DER-VEN (L2)	0.26	13.9	3.6	110	397.
ANN DER SYR (L1)	0.40	10.5	4.2	26	110.
ARCH DERM F (L2)	0.33	15.7	5.2	105	546.
ARCH DERMAT (L2)	0.75	13.1	9.8	255	2507.
B S FR D SY (L1)	0.60	19.3	11.6	26	301.
BERUFS-DERM (L2)	0.07	9.0	0.6	31	20.
BR J DERM (L2)	0.48	11.8	5.7	224	1272.
BR J VEN DI (L2)	0.40	9.1	3.6	148	536.
DERMATOLOG (L1)	0.21	13.2	2.6	125	350.
HAUTARZT (L1)	0.10	16.4	1.6	122	194.

JOURNAL ASSIGNMENTS & INFLUENCE MEASURES (1973 DATA)
31-JAN-75

	INFL WT	REFS /PUB	INFL /PUB	PUBS	TOT INFL
CLINICAL MEDICINE (CONTINUED)					
DERMATOLOGY & VENEREAL DISEASES (CONTINUED)					
J INVES DER (L3)	0.75	19.8	14.8	131	1935
ENDOCRINOLOGY					
ACT DIABET (L3)	0.18	22.3	4.0	38	151.
ACT ENDOC P (L3)		11.0		18	
ACT ENDOCR (L3)	0.69	24.9	17.2	247	4248.
ANN ENDOCR (L3)	0.46	3.8	4.4	119	530.
DIABETES (L3)	1.83	23.3	42.6	93	3959.
DIABETOLOG (L3)	0.75	18.7	14.0	75	1047.
ENDOCR EXP (L3)	0.04	12.3	0.5	43	22.
ENDOCR JAP (L3)	0.36	16.6	6.0	77	465.
ENDOCRINOL (L3)	1.83	19.5	35.7	495	17676.
ENDOKRINOL (L3)	0.13	16.1	2.1	88	184.
GEN C ENDOC (L4)	0.82	19.2	15.8	143	2256.
HORMONE MET (L3)	0.24	13.3	3.2	170	544.
HORMONE RES (L3)	0.29	16.0	4.7	43	205.
J CLIN END (L3)	1.90	17.2	32.6	349	11384.
J ENDOCR (L3)	0.87	17.3	15.1	329	4955.
METABOLISM (L3)	0.74	23.7	17.6	155	2726.
NEUROENDOCR (L3)	0.76	18.7	14.2	73	1037.
PROSTAGLAND (L3)	0.21	13.7	2.9	165	480.
FERTILITY					
BIOL REPROD (L3)	0.39	24.6	9.6	105	1007.
CONTRACEPT (L2)	0.24	13.0	3.1	75	232.
FERT STERIL (L2)	0.73	12.9	9.4	140	1317.
INT J FERT (L2)	0.32	12.9	4.2	48	202.
J REPR FERT (L3)	0.62	13.4	8.3	337	2790.
GASTROENTEROLOGY					
ACT HEP-SPL (L2)	0.06	16.7	0.9	69	66.
AM J DIG DI (L2)	0.42	18.7	7.8	153	1187.
AM J GASTRO (L1)	0.18	11.4	2.0	123	250.
ANN GASTRO (L1)		10.9		54	
ARCH FR MAL (L2)	0.23	20.5	4.8	55	262.
BIBL GASTRO (L2)		0.0		0	
BIOL GASTRO (L2)	0.10	22.3	2.3	22	50.
DIGESTION (L2)	0.15	21.1	3.1	62	255.
GASTROENTY (L2)	1.19	29.6	35.2	182	6406.
GUT (L2)	0.64	21.2	13.7	177	2418.
LEBER MAG O (L2)	0.05	11.0	0.6	41	36.
REND GASTRO (L2)		22.8		20	
SC J GASTR (L2)	0.28	16.0	4.5	164	736.
Z GASTROENT (L2)	0.04	11.9	0.5	97	50.
GERIATRICS					
ACT GERONT (L1)		11.5		22	
EXP GERONT (L3)	0.21	20.0	4.1	36	149.
GERIATRICE (L1)	0.25	8.9	2.2	111	244.

JOURNAL ASSIGNMENTS & INFLUENCE MEASURES (1973 DATA)
31-JAN-75

	INFL WT	REFS /PUB	INFL /PUB	PUBS	TOT INFL
CLINICAL MEDICINE (CONTINUED)					
GERIATRICS (CONTINUED)					
GERONT CLIN (L2)	0.21	8.8	1.9	35	66
GERONTOL (L1)	0.37	5.9	2.2	79	171
GERONTOLOG (L2)	0.20	26.1	5.3	38	201
GIOR GERONT (L2)	0.03	9.8	0.3	60	19
J AM GER SO (L1)	0.31	9.3	2.9	89	262
J GERONTOL (L2)	1.22	11.5	14.0	63	884
HEMATOLOGY					
ACT HAEMAT (L3)	0.54	14.3	7.7	99	762
BIBL HAEM (L2)		0.0		0	
BLOOD (L3)	1.91	19.8	37.8	166	6281
BLUT (L3)	0.18	18.8	3.4	81	272
BR J HAEM (L3)	0.93	18.4	17.2	167	2874
NOUV RF HEM (L3)	0.48	15.0	7.2	86	618
REV FR TRAN (L3)	0.04	8.4	0.3	36	13
SC J HAEMAT (L2)	0.31	21.5	6.8	104	704
SEM HEMATOL (L2)	0.36	78.3	27.9	21	586
THROMB DIAT (L3)	1.00	18.8	18.9	117	2208
TRANSFUSION (L2)	0.80	9.0	7.2	77	555
VOX SANGUIN (L3)	0.82	10.1	8.3	158	1307
IMMUNOLOGY					
ACT PAT S B (L3)		0.0		0	
ACT PATH SC (L3) (50%)	[0.61]	17.0	[10.4]	290	[3009]
ANN IMMUNOL (L3)		0.0		0	
ANN IN PAST (L3)	1.00	19.9	19.6	88	1745
B I PASTEUR (L3)	0.06	95.7	5.9	12	70
B IST SIER (L3)	0.06	12.4	0.6	35	27
BIKEN J (L3)	1.15	11.9	13.7	22	361
CELL IMMUN (L3)	0.67	20.6	13.9	194	2692
CLIN EXP IM (L2)	0.71	19.9	14.2	211	2395
CLIN IMMUN (L3)	0.08	23.0	1.9	35	65
EUR J IMMUN (L3)	0.56	20.7	11.0	161	1847
IMMUNOCHEM (L3)	1.03	20.2	20.9	111	2318
IMMUNOL COM (L3)		13.5		72	
IMMUNOLOGY (L3)	1.29	19.0	24.5	217	5325
INFEC IMMUN (L3)	0.21	17.1	3.8	325	1130
J EXP MED (L3)	4.22	22.3	96.3	245	23584
J HYG EP MI (L2)	0.20	7.8	1.6	60	95
J IMMUNOL (L3)	1.71	19.9	34.2	473	16133
J IMMUNOL N (L3)	0.09	13.2	1.2	69	86
J INFEC DIS (L2)	0.70	19.8	13.8	251	2469
J RETIC SOC (L3)	0.42	19.6	0.2	30	776
JAP J EXP M (L3)	0.07	14.1	8.1	49	396
MED MICROBI (L3)	0.18	14.1	5.4	29	157
REV IMMUNOL (L3)	0.17	22.4	5.6	7	39
SC J IMMUN (L3)	0.29	16.0	4.8	73	348
TISSUE ANTI (L3)	0.50	13.8	6.8	44	261
TRANSPLAN R (L3)	1.31	62.0	62.9	18	1073

JOURNAL ASSIGNMENTS & INFLUENCE MEASURES (1975 DATA)
31-JAN-75

	INFL WT	REFS /PUB	INFL /PUB	PUBS	TOT INFL
CLINICAL MEDICINE (CONTINUED)					
IMMUNOLOGY (CONTINUED)					
TRANSPLANT F (L3)	0.65	9.4	6.1	291	1775.
TRANSPLANT (L3)	1.08	15.0	16.2	236	3830.
Z IMMUN EXP (L3)	0.30	15.7	4.7	76	359.
ZH MIKROB E (L3)	0.08	8.7	0.7	347	229.
OBSTETRICS & GYNECOLOGY					
ACT OBST SC (L2)	0.30	19.6	5.9	73	430.
ADV OBSTET (L2)		0.0		0	
AM J OBST G (L2)	0.92	11.7	10.7	549	5902.
ARCH GYNAR (L2)	0.28	17.8	5.0	53	267.
AUST NZ J O (L1)	0.08	13.8	1.1	43	49.
FORTSC GEE (L2)		0.0		0	
GYNAKOLOGE (L2)	0.06	30.3	1.9	23	44.
GYNECOL INV (L3)	0.14	17.5	2.4	54	128.
J OBSTET GY (L2)	0.78	10.2	8.0	212	1704.
J REPRD MED (L1)	0.12	13.2	1.5	95	143.
OBSTET GYN (L1)	0.61	10.9	6.7	301	2008.
REV F GY OB (L2)	0.01	15.3	0.2	99	22.
NEUROLOGY & NEUROSURGERY					
ACT NEUR SC (L2)	0.47	16.0	7.5	75	563.
ACT NEUROE (L4)	0.05	15.6	0.8	54	42.
ACT NEUROCH (L1)	0.22	14.5	3.2	35	111.
ACT NEUROF (L3)	0.29	19.3	5.6	146	621.
ACTIV NERV (L2)	0.20	7.1	1.4	69	97.
ARCH NE PSY (L1) (70%)	[1.06]	13.8	[16.8]	170	[6206.]
ARCH NEURCL (L2)		0.0		0	
ARCH PSYCHI (L1) (50%)	[0.45]	17.4	[7.9]	44	[348.]
BRAIN (L2)	1.72	20.6	15.4	63	2230.
BRAIN BEHAV (L4)	0.17	34.3	5.7	47	268.
BRAIN RES (L4)	0.46	20.0	9.5	772	7342.
CONF NEUROL (L2)	0.37	9.9	3.7	42	150.
DEVELOP MED (L2)	0.37	11.1	4.1	119	488.
EEG CL NEUR (L3)	1.50	13.9	20.8	166	3409.
EPILEPSIA (L2)	0.61	19.2	11.6	33	382.
EUR NEUROL (L2)		0.0		0	
EXP BRAIN R (L4)	0.90	23.3	22.2	104	2307.
EXP NEUROL (L4)	0.68	18.3	12.8	248	3179.
F NEUR PSYC (L1) (50%)	[0.06]	43.3	[2.6]	29	[77.]
HEADACHE (L1)	0.13	13.1	1.7	18	31.
INT J NEURO (L3)		0.0		0	
INT J NEURS (L4)	0.44	13.3	5.9	26	160.
J COMP NEUR (L4)	1.06	28.8	10.6	140	4290.
J NE EXP NE (L3)	1.67	23.7	19.5	39	1040.
J NE NE PSY (L2)	0.80	14.8	11.6	143	1717.
J NEUR SCI (L2)	0.31	19.5	6.1	112	687.
J NEURAL TR (L4)	0.23	19.0	4.4	26	115.
J NEUROBIOL (L4)	0.35	22.7	7.9	38	301.
J NEUROCHEM (L4)	0.88	22.2	19.6	366	7224.

JOURNAL ASSIGNMENTS & INFLUENCE MEASURES (1973 DATA)
31-JAN-75

	INFL WT	REFS /PUB	INFL /PUB	PUBS	TOT INFL
CLINICAL MEDICINE (CONTINUED)					
NEUROLOGY & NEUROSURGERY (CONTINUED)					
J NEUROCYT (L4)		24.7		51	
J NEUROSURG (L1)	0.77	11.3	8.7	256	2235.
J NEURPHYSL (L4)	2.80	30.0	84.2	79	6653.
MONAT PSYCHI (L2) (50%)	[0.21]	16.2	[3.4]	68	[230.]
NERVENARZT (L1)	0.09	19.6	1.8	100	192.
NEURO-CHIRE (L2)	0.13	14.1	1.8	59	108.
NEUROBIOLOG (L4)	0.10	21.2	2.1	30	64.
NEUROCHIRA (L2)	0.20	10.9	2.2	27	60.
NEUROLOGY (L2)	0.95	15.7	14.9	185	2751.
NEURODIAT (L2)	0.12	17.4	2.0	39	80.
PSYCHIAT NE (L2) (40%)	[0.44]	10.4	[4.6]	45	[207.]
REV NEUROL (L1)	0.65	14.8	9.7	80	775.
SOV NEUR R (L3) (50%)		4.3		30	
VISION RES (L4)	0.87	17.0	14.9	261	2985.
Z NEUROL (L2)	0.25	21.0	5.1	61	314.
ZH VYSS NER (L4)	0.09	8.6	0.8	200	152.
OPHTHALMOLOGY					
A GRAEFES A (L2)	0.25	11.3	2.8	96	269.
ACT OPHTH K (L2)	0.31	12.8	4.0	118	472.
ADV OPHTHAL (L2)		0.0		0	
AM J OPHTH (L2)	0.86	9.5	8.2	297	2424.
AM J OPTOM (L2)	0.30	7.1	2.1	89	183.
ARCH OPHTAL (L2)	0.85	24.5	1.2	57	67.
ARCH OPHTH (L2)	0.82	15.4	12.6	197	2474.
ARCH S A OF (L2)		6.7		3	
BR J OPHTH (L2)	0.77	9.2	7.1	123	872.
BR J PHYS O (L3)		19.4		5	
CAN J OPHTH (L2)	0.15	6.7	1.0	102	103.
DOC OPHTHAL (L2)	0.11	34.1	3.6	29	105.
EXP EYE RES (L3)	0.32	16.9	5.4	145	782.
EYE EAR NOS (L1) (50%)	[0.13]	6.7	[0.9]	41	[36.]
INV OPHTH (L3)	0.65	12.8	8.4	130	1067.
KLIN MONATS (L1)	0.23	9.3	2.1	220	471.
OPHTHAL RES (L3)	0.11	11.9	1.3	66	84.
OPHTHALMOLA (L2)	0.46	7.3	3.3	111	370.
ORTHOPEDICS					
ACT ORTH SC (L1)	0.16	22.1	4.0	80	322.
ARCH ORTHOP (L1)	0.06	11.3	0.6	116	73.
CLIN ORTHOP (L2)	0.31	12.5	3.8	251	961.
INJURY (L1)	0.07	6.7	0.5	61	30.
J BONE JOIN (L1)	1.85	12.6	20.7	181	3754.
RECONS SURG (L1)		0.0		0	
REV CHIR OR (L1)	0.34	4.5	1.1	64	92.
Z ORTHOP GR (L1)	0.11	4.1	0.5	236	103.
ARTHRITIS & RHEUMATISM					
ANN RHEUM D (L2)	0.86	16.6	14.3	91	1300.

JOURNAL ASSIGNMENTS & INFLUENCE MEASURES (1973 DATA)
31-JAN-75

	INFL WT	REFS /PUB	INFL /PUB	FUBS	TOT INFL
CLINICAL MEDICINE (CONTINUED)					
ARTHRITIS & RHEUMATISM (CONTINUED)					
ARTH RHEUM (L2)	1.09	19.4	21.2	85	1799.
REV RHUM (L2)	0.12	10.7	1.3	105	138.
Z RHEUMAFOR (L2)	0.15	16.3	2.5	34	84.
OTORHINOLARYNGOLOGY					
ACT OTO-LAR (L2)	0.44	11.9	5.3	207	1069.
ADV OTO-RH (L2)		0.0		0	
ANN OTOL RH (L2)	0.47	13.0	6.1	125	766.
ARCH KL EXP (L2)	0.16	23.6	3.8	48	184.
ARCH OTOLAR (L1)	0.51	9.0	4.7	204	949.
AUDIOLOGY (L3)	0.13	11.9	1.5	26	42.
EYE EAR NOS (L1) (50%)	[0.13]	6.7	[0.9]	41	[36.]
HND WEG FAC (L2)	0.05	9.0	0.5	76	36.
J SPEECH HE (L2)	0.25	6.6	1.7	90	152.
LARYNGOSCOOP (L1)	0.45	12.3	5.5	136	752.
ORL-J OTO R (L1)	0.16	6.5	1.1	66	70.
PATHOLOGY					
ACT PAT JAP (L3)	0.11	15.5	1.7	73	127.
ACT PAT S A (L3)		0.0		0	
ACT PATH SC (L3) (50%)	[0.61]	17.0	[10.4]	290	[3009.]
AM J CLIN P (L2)	1.04	11.9	12.3	254	2132.
AM J PATH (L3)	1.44	22.4	32.4	146	4725.
ARCH PATH (L2)	1.16	16.0	18.6	167	3478.
BEITR PATH (L3)	0.26	18.6	4.9	101	492.
BR J EX PAT (L3)	1.71	17.0	29.0	65	1883.
EXP MOL PAT (L3)	0.56	22.4	12.6	75	945.
EXP PATH (L3)	0.02	16.3	0.3	64	23.
HUMAN PATH (L2)	0.20	24.5	5.0	51	254.
J CLIN PATH (L2)	1.07	12.4	13.3	190	2529.
J COMP PATH (L3)	0.75	12.5	9.3	64	596.
J PATH BACT (L3)	1.15	16.0	16.4	191	3507.
J PATHOLOGY (L3)		0.0		0	
LAB INV (L3)	1.03	25.5	26.2	151	3964.
PATH BIOL (L3)	0.12	22.8	2.8	179	503.
PATH EUROP (L3)	0.28	15.9	4.5	19	86.
PATH MICROB (L3)	0.41	8.6	3.5	95	334.
PATHOLOGY (L3)	0.36	16.2	5.8	37	215.
PATOLOGIA (L2)		18.7		15	
SPERIMENTAL (L3)		21.0		4	
VIRCH ARC (L3)	0.37	21.2	7.9	197	1666.
PEDIATRICS					
ACT PAED H (L1)	0.24	13.6	3.2	40	129.
ACT PAED SC (L2)	0.51	18.7	9.6	115	1106.
AM J DIS CH (L2)	0.98	13.4	13.1	250	3262.
ARCH DIS CH (L2)	0.76	13.6	10.2	207	2132.
ARCH PR PED (L2)	0.25	18.1	4.5	74	334.
AUST PAEDIA (L1)	0.23	13.3	3.0	22	67.

JOURNAL ASSIGNMENTS & INFLUENCE MEASURES (1973 DATA)
31-JAN-75

INFL REFS INFL TOT
WT /PUB /PUB PUBS INFL

CLINICAL MEDICINE (CONTINUED)

PEDIATRICS (CONTINUED)

BIOL NEONAT (L3)	0.33	18.6	6.1	73	445.
CLIN PEDIAT (L1)	0.26	8.2	2.1	154	328.
GASLINI (L1)		7.7		29	
HELV PAED R (L2)	0.19	28.1	5.3	61	321.
J PEDIAT (L2)	0.88	15.6	13.8	364	5889.
KLIN PADIAT (L2)		13.3		74	
MON PAEDIAT (L2)		0.0		0	
MONATS KIND (L2)	0.09	10.2	0.9	201	177.
PADIATR PRO (L2)	0.03	10.5	0.3	51	15.
PED CLIN NA (L2)	0.25	20.0	5.1	71	362.
PEDIAT RES (L3)	0.56	21.7	12.1	104	1255.
PEDIATRICS (L2)	1.20	15.2	18.2	290	5292.
Z KINDERHEI (L2)	0.16	19.8	3.3	79	258.

PHARMACOLOGY

ACT PHARM T (L3)	0.69	16.4	11.2	88	987.
AGENT ACTIO (L3)		8.4		55	
AGRESSOLOG (L3)	0.23	6.8	1.5	56	86.
ANN R PHARM (L3)	0.27	115.4	31.4	24	753.
ANTIBIOTIKI (L4)	0.25	7.3	1.8	252	454.
ANTIM AG CH (L3)	0.33	13.5	4.5	251	1124.
ARCH I PHAR (L3)	0.64	15.3	9.7	238	2318.
ARCH TOXIK (L3)	0.19	10.7	2.0	62	127.
ARZNEI-FOR (L3)	0.29	12.8	3.7	464	1726.
BIOCH PHARM (L3)	0.80	18.7	14.9	415	6183.
BR J PHARM (L3)	1.52	20.1	30.5	227	6935.
CHEMOTHERA (L3)	0.28	10.4	2.9	62	178.
CLIN PHARM (L2)	0.62	18.1	11.2	126	1407.
CLIN TOXIC (L2)	0.15	17.4	2.6	50	129.
COMP GEN PH (L4)	0.22	17.9	3.9	51	200.
CURR THER R (L1)	0.45	7.7	3.5	103	359.
DRUG META D (L3)		21.0		101	
DRUG METAB (L3)		76.8		9	
DRUGS (L1)	0.02	40.4	0.7	32	21.
ERGEB PHYSI (L4) (30%)	[0.45]	260.7	[116.5]	3	[350.]
EUR J CL PH (L2)	0.10	14.7	1.5	70	104.
EUR J PHARM (L3)	0.61	16.6	10.1	257	2588.
FARMAKOL T (L3)	0.08	8.9	0.7	201	135.
FDA CONSUM (L2)		0.0		38	
FOOD COSMET (L3)	0.21	15.3	3.1	78	245.
INT J CL PH (L2)	0.06	9.8	0.6	103	57.
J ANTIBIOT (L4)	1.03	12.0	12.4	112	1384.
J CLIN PHAR (L1)	0.34	11.3	3.9	58	224.
J PHAR BIOP (L4)		14.3		18	
J PHARM EXP (L3)	1.70	22.7	38.4	324	12455.
J PHARM PHA (L3)	1.11	18.8	20.9	131	2734.
J PHARMACOL (L3)	0.08	18.7	1.5	43	67.
JAP J PHARM (L3)	0.25	12.9	3.3	117	383.
MED PHAR EX (L3)	0.15	16.1	2.4	160	382.

JOURNAL ASSIGNMENTS & INFLUENCE MEASURES (1973 DATA)
31-JAN-75

	INFL WT	REFS /PUB	INFL /PUB	PUBS	TOT INFL
CLINICAL MEDICINE (CONTINUED)					
PHARMACOLOGY (CONTINUED)					
MOLEC PHARM (L3)	1.49	24.8	36.9	89	3286.
N-S ARCH PH (L3)	0.68	18.1	12.4	205	2534.
NEUROPHARM (L3)	0.52	18.9	9.8	121	1182.
P WEST PH S (L3)	0.12	5.2	0.6	78	47.
PHARM REV (L3)	0.90	155.7	139.7	23	3213.
PHARMACOL (L3)		0.0		0	
PHARMACOL R (L3)	0.11	12.5	1.4	48	69.
PHARMACOLOG (L3)		0.0		0	
POL J PHAR (L3)		13.4		76	
PSYCHOPHARM (L3)	0.50	16.9	8.5	217	1851.
RES COMM CP (L3)	0.12	10.6	1.2	215	264.
THERAPIE (L3)	0.15	14.2	2.1	85	178.
TOX APPL PH (L3)	0.33	14.8	4.8	211	1021.
TOXICON (L3)	0.44	11.3	5.0	73	368.
XENOBIOTICA (L3)	0.10	19.5	2.0	64	125.
PHARMACY					
ACT PHARM S (L3)	0.23	13.3	3.0	56	171.
ACT POL PH (L3)	0.04	6.0	0.2	102	21.
AM J HOSP P (L1)	0.07	8.6	0.6	112	65.
AM J PHAR E (L1)		2.8		43	
AM J PHARM (L1)	0.14	11.5	1.6	22	36.
ANN PHARM F (L3)	0.15	9.4	1.4	85	122.
ARCH PHARM (L3)	0.43	9.6	4.1	124	513.
CAN J PH SC (L3)	0.05	13.3	0.6	41	26.
CHEM PHARM (L3)	0.25	12.1	3.1	511	1574.
CHIM THER (L3)	0.07	11.3	0.8	84	71.
DRUG COSMET (L1)		1.3		32	
DRUG INTEL (L1)	0.02	28.0	0.5	54	25.
FARMACO (L3)	0.04	12.6	0.5	130	66.
J AM PHARM (L1)	0.41	6.2	2.6	53	136.
J MED CHEM (L3)	0.41	15.1	6.3	390	2445.
J PHARM SCI (L3)	0.28	16.4	4.7	496	2306.
KHIM FAR ZH (L3)	0.09	3.5	0.3	231	76.
PHARM ACT H (L2)	0.19	9.0	1.7	56	98.
PHARM PRAK (L2)		1.9		53	
PHARMAZIE (L3)	0.06	18.6	1.2	200	238.
PROD P PHAR (L3)		21.4		17	
YAKUGAKU ZA (L3)	0.31	7.4	2.3	283	651.
PSYCHIATRY					
ACT PSYC SC (L2)	0.51	12.1	6.2	99	616.
ADV PSY MED (L3)		0.0		0	
AM J ORTHOP (L1)	2.19	1.7	3.7	142	532.
AM J PSYCHA (L1)		3.5		14	
AM J PSYCHI (L1)	1.09	8.8	9.6	243	2323.
AM J PSYCHT (L1)	0.53	4.6	2.4	40	97.
ARCH G PSYC (L1)		0.0		0	
ARCH NE PSY (L1) (30%)	[1.06]	15.8	[16.8]	370	[6206.]
ARCH PSYCHI (L1) (50%)	[0.45]	17.4	[7.9]	44	[348.]
BIOL PSYCHI (L2)	0.25	15.0	3.7	52	194.

JOURNAL ASSIGNMENTS & INFLUENCE MEASURES (1973 DATA)
31-JAN-75

	INFL WT	REFS /PUB	INFL /PUB	PUBS	TOT INFL
CLINICAL MEDICINE (CONTINUED)					
PSYCHIATRY (CONTINUED)					
BR J PSYCHI (L1)	1.14	10.6	12.1	176	2126.
COMP PSYCHI (L1)	0.37	8.5	3.1	61	192.
CONF PSYCH (L1)		10.6		9	
DIS NER SYS (L1)	0.53	13.3	7.1	66	467.
F NEUR PSYC (L1) (50%)	[0.06]	43.3	[2.6]	29	[77.]
INT J GRP P (L1)	0.15	15.5	2.3	33	75.
INT J PSYCH (L1)	2.24	12.9	28.9	18	520.
INT PHARMAC (L1)	0.10	17.3	1.7	24	41.
J AM A CHIL (L1)		3.9		35	
J NERV MENT (L1)	1.28	11.1	14.3	81	1156.
J PSYCH RES (L2)	1.30	17.7	23.1	16	370.
J PSYCHOSOM (L2)	0.99	11.7	11.6	27	312.
MONAT PSYCHI (L2) (50%)	[0.21]	16.2	[3.4]	68	[230.]
PHARMAKOPSY (L2)	0.22	12.8	2.8	27	75.
PSYCHIAT CL (L1)		0.0		0	
PSYCHIAT NE (L2) (50%)	[0.44]	10.4	[4.6]	45	[207.]
PSYCHIAT O (L1)	0.43	5.1	2.2	60	131.
PSYCHIATRY (L1)	2.00	6.3	12.7	29	369.
PSYCHOAN RE (L1)		9.4		7	
PSYCHOL MED (L1)	0.15	18.9	2.8	48	134.
PSYCHOS MED (L2)	1.19	18.9	22.4	42	940.
PSYCHOSOMAT (L1)	0.13	14.6	1.9	55	104.
PSYCHOTH PS (L1)	0.12	3.7	0.4	76	34.
SEM PSYCHIA (L1)	0.08	14.8	1.2	31	36.
SOCIAL PSY (L1)	0.26	9.0	2.3	30	70.
SOV NEUR R (L3) (50%)		4.3		30	
RADIOLOGY & NUCLEAR MEDICINE					
ACT ISOTOP (L3)		0.0		0	
ACT RADIOL (L2)	0.74	12.9	9.5	141	1339.
AM J ROENTG (L1)	0.61	12.0	9.7	306	2974.
ANN RADIOL (L1)	0.14	10.8	1.5	86	127.
AUST RADIOL (L1)	0.03	8.7	0.2	90	21.
BIBL RADIOL (L2)		0.0		0	
BR J RADIOL (L2)	0.94	11.6	11.0	161	1773.
F ROENT NUK (L1)	0.15	12.6	1.9	243	457.
INT J A RAD (L3)	1.42	6.4	9.1	140	1273.
INT J RAD B (L4)	0.80	16.4	13.0	125	1629.
INV RADIOL (L2)	0.44	10.8	4.7	61	287.
J BELG RAD (L2)	0.06	8.4	0.5	54	27.
J NUCL BIOL (L3)	0.06	13.1	0.8	67	55.
J NUCL MED (L2)	0.81	9.1	7.4	180	1336.
J RADIOL (L1)	0.20	6.7	1.3	125	167.
MIN RAD (L1)		0.0		0	
NEURORADIOL (L1)	0.07	10.8	0.8	87	68.
NUCL MED (L2)	0.14	11.7	1.6	46	76.
POL REV RAD (L1)	0.01	6.5	0.1	81	5.
RAD CLIN (L1)	0.11	8.3	0.9	54	48.
RAD CLIN NA (L1)	0.20	27.6	5.6	38	211.

JOURNAL ASSIGNMENTS & INFLUENCE MEASURES (1973 DATA)
31-JAN-75

		INFL WT	REFS /PUB	INFL /PUB	FUBS	TOT INFL
CLINICAL MEDICINE (CONTINUED)						
RADIOLOGY & NUCLEAR MEDICINE (CONTINUED)						
RAD DIAGN	(L2)	0.03	5.8	0.2	100	17.
RAD RAD FIS	(L2)		19.4		5	
RADIAT DATA	(L3)		6.6		17	
RADIAT RES	(L4)	1.26	16.3	20.4	197	4027.
RADIOLOGE	(L1)	0.06	13.1	0.8	96	81.
RADIOLOGY	(L2)	0.71	9.2	6.5	555	3619.
SEM ROENTG	(L1)	0.08	5.2	0.4	122	52.
STRAHLENTHE	(L2)	0.23	14.8	3.3	146	496.
RESPIRATORY SYSTEM						
AM R RESP D	(L2)	0.52	13.6	7.1	372	2645.
B PHYSIO PA	(L3)	0.05	13.4	0.7	138	91.
BIBL TUB ME	(L2)		0.0		0	
CHEST	(L1) (20%)	[0.30]	12.8	[3.8]	404	[1541.]
FNEUMONOL-P	(L2)	0.13	13.1	1.7	43	73.
RESP PHYSL	(L4)	0.87	17.9	15.6	84	1306.
RESPIRATION	(L2)	0.24	16.9	4.1	59	242.
SC J RESP D	(L2)	0.34	10.8	3.7	65	239.
THORAX	(L1)	0.79	12.1	9.6	114	1093.
SURGERY						
ACT CHIR H	(L1)		17.1		40	
ACT CHIR SC	(L2)	0.69	13.5	9.2	142	1312.
AM J SURG	(L1)	0.78	11.6	9.0	327	2953.
ANN CHIR	(L1)	0.07	9.4	0.6	224	141.
ANN CHIR GY	(L2)	0.06	13.0	0.9	77	65.
ANN CHIR IN	(L1)	0.04	9.7	0.4	47	17.
ANN CHIR PL	(L1)	0.04	5.5	0.2	47	11.
ANN SURG	(L1)	1.32	15.1	20.0	272	5440.
ARCH SURG	(L1)	0.97	12.1	11.8	336	3965.
AUST NZ J S	(L1)	0.11	8.7	0.9	110	103.
BR J SURG	(L1)	0.74	12.0	8.9	266	2362.
CAN J SURG	(L1)	0.29	11.5	3.3	64	214.
CHIR PLAST	(L1)		8.5		24	
CHIRURG	(L1)	0.21	5.6	1.2	144	167.
DIS COL REC	(L1)	0.35	9.9	3.5	65	224.
EUR SURG RE	(L2)	0.20	14.6	2.9	26	75.
HELV CHIR A	(L1)	0.07	5.3	0.4	137	53.
J CARD SURG	(L1)	0.25	10.3	2.6	89	232.
J CHIR	(L1)	0.10	14.4	1.4	69	97.
J PED SURG	(L1)	0.54	10.8	5.8	99	575.
J SURG RES	(L2)	0.26	14.3	3.7	147	538.
J THOR SURG	(L1)	0.86	10.9	9.4	287	2706.
J TRAUMA	(L1)	0.37	10.8	4.0	161	646.
LANGENBECK	(L1)	0.83	11.9	9.9	32	318.
MONATS UNFA	(L1)	0.09	5.0	0.5	70	32.
PLAS R SURG	(L1)	0.41	8.5	3.5	181	626.
PROG SURG	(L2)		0.0		0	
SC J PLAST	(L1)		11.3		23	

JOURNAL ASSIGNMENTS & INFLUENCE MEASURES (1973 DATA)
31-JAN-75

	INFL WT	REFS /PUB	INFL /PUB	PUBS	TOT INFL
CLINICAL MEDICINE (CONTINUED)					
SURGERY (CONTINUED)					
SURG CL NA (L1)	0.49	11.8	5.7	133	763.
SURG GYN OB (L1)	1.48	10.9	16.1	255	4118.
SURG ITAL (L1)		8.0		25	
SURGERY (L1)	1.09	14.6	15.9	264	4198.
T AM S ART (L1)	0.28	14.5	4.1	179	736.
Z KIND CH G (L1)	0.03	8.7	0.3	124	37.
TROPICAL MEDICINE					
AM J TROP M (L2)	1.12	12.1	13.5	145	1952.
ANN TROP M (L2)	1.38	9.4	13.0	58	755.
J TROP MED (L2)	0.42	7.7	3.3	76	248.
T RS TROP M (L2)	1.01	16.5	16.7	81	1353.
TROP GEO ME (L1)	0.22	9.5	2.1	64	132.
Z TROP PARA (L2)	0.33	10.9	3.6	54	195.
UROLOGY					
ANN UROL (L1)	0.19	7.7	1.5	37	54.
INV UROL (L2)	0.30	11.3	3.3	104	346.
J UROL (L1)	0.80	8.2	6.5	492	3193.
J UROL NEPH (L1)	0.08	19.4	1.5	81	121.
SC J UROL N (L2)	0.19	9.4	1.8	68	121.
UROL INTERN (L1)	0.22	5.1	1.1	81	90.
UROLOGE (L1)	0.08	13.0	1.1	63	67.
NEPHROLOGY					
KIDNEY INT (L3)	0.09	30.2	2.7	94	258.
NEPHRON (L2)	0.26	18.4	4.9	95	463.
VETERINARY MEDICINE					
ACT VET H (L3)	0.20	10.0	2.0	36	73.
ACT VET SC (L3)	0.15	14.0	2.1	91	193.
AM J VET RE (L3)	0.44	12.7	5.6	293	1641.
AUST VET J (L2)	0.27	13.4	3.6	103	372.
AVIAN DIS (L3)	0.51	9.9	5.0	105	529.
BR VET J (L2)	0.46	7.4	3.4	104	355.
CAN J COM M (L3)	0.34	11.6	3.9	69	270.
CAN VET J (L2)	0.26	7.1	1.9	60	112.
CORNELL VET (L2)	0.39	20.5	8.1	42	339.
J AM VET ME (L2)	0.33	11.0	3.6	261	1014.
J AM VET RA (L1)	0.08	8.6	0.7	15	10.
J SM ANIM P (L1)	0.14	11.0	1.5	60	89.
JAP J VET R (L3)	0.21	7.4	1.5	32	34.
JAP J VET S (L3)	0.09	11.1	1.0	43	43.
NAT I ANIM (L3)	0.26	10.1	2.6	24	63.
NORD VETMED (L2)	0.13	9.4	1.2	79	96.
RES VET SCI (L2)	0.34	9.7	3.3	162	536.
VET MED/SAC (L1)	0.35	3.9	1.4	154	214.
VET PATH (L3)	0.26	14.5	3.7	45	167.
VET REC (L2)	0.55	9.4	5.2	261	1344.

JOURNAL ASSIGNMENTS & INFLUENCE MEASURES (1973 DATA)
31-JAN-75

	INFL WT	REFS /PUB	INFL /PUB	PUBS	TOT INFL
CLINICAL MEDICINE (CONTINUED)					
VETERINARY MEDICINE (CONTINUED)					
Z VERS KUND (L2)	0.14	9.9	1.4	33	47.
ZBL VET (L3)	0.10	11.2	1.2	150	177.
ADDICTIVE DISEASES					
B NARCOTICS (L1)	0.22	16.3	3.7	25	91.
BR J ADDICT (L2)	0.40	8.1	3.2	29	94.
INT J ADDIC (L1)	0.14	11.8	1.7	60	100.
Q J STUD AL (L2)	0.77	10.8	8.3	89	740.
HYGIENE & PUBLIC HEALTH					
AM IND HYG (L3)	0.40	5.7	2.3	143	329.
AM J EPIDEM (L2)	1.64	14.6	23.9	93	2224.
AM J PUB HE (L1)	1.81	4.4	8.1	148	1191.
ARCH ENV HE (L2)	1.22	10.1	12.4	150	1858.
ARCH MAL FR (L2)	0.18	7.0	1.3	28	36.
B OF SAN FA (L1)	0.01	12.4	0.1	70	6.
B WHO (L2)	1.39	12.3	17.2	127	2187.
BR J IND ME (L1)	1.59	8.5	13.5	54	731.
BR J PREV S (L1)	2.25	7.6	17.2	38	654.
ENVIR RES (L2)	0.19	18.8	3.5	41	144.
HEALTH SERV (L1)	1.27	4.5	5.7	138	785.
IND MED SUR (L1)	0.93	3.9	3.7	30	110.
INT A ARE (L2)		12.7		44	
J AIR POLLU (L2)	1.24	5.2	6.5	102	662.
J HYG CAME (L2)	1.04	11.1	11.5	99	1137.
NUCL SAFETY (L3)	0.33	2.6	0.9	90	76.
PUBL HEAL (L1)	0.13	4.9	0.6	32	20.
REV EPIDEM (L2)		8.7		39	
WHO CHRON (L1)		1.9		28	
MISCELLANEOUS CLINICAL MEDICINE					
AEROSP MED (L2)	0.37	8.9	3.2	206	667.
AM J PHYS M (L2)	0.41	11.1	4.5	24	108.
ARCH PHYS M (L1)	0.26	7.2	1.9	108	205.
KOSM BIOL M (L2)		0.0		0	
RIV MED AER (L2)	0.03	13.2	0.4	13	5.
BIOMEDICAL RESEARCH					
PHYSIOLOGY					
ACT PHYSL H (L4) *	0.44	14.7	6.4	63	404.
ACT PHYSL L (L4)	0.26	18.3	4.7	43	202.
ACT PHYSL P (L4)	0.03	15.5	0.4	151	59.
ACT PHYSL S (L4)	2.32	21.3	49.5	206	10207.
ADV R PHYSL (L4)		0.0		0	
AM J PHYSL (L4)	2.10	21.6	45.3	536	24297.
ANN R PHYSL (L4)	0.57	117.0	66.8	16	1069.
ARCH SCI PH (L4)	0.31	16.3	8.3	20	167.
CAN J PHYSL (L4)	0.94	16.6	15.7	160	2507.

*Level Indicator: (L1)=Level 1, (L2)=Level 2, etc. See III-C-2.

JOURNAL ASSIGNMENTS & INFLUENCE MEASURES (1973 DATA)
31-JAN-75

	INFL WT	REFS /PUB	INFL /PUB	PUBS	TOT INFL
BIOMEDICAL RESEARCH (CONTINUED)					
PHYSIOLOGY (CONTINUED)					
ERGEB PHYSI (L4) (30%)	[0.45]	260.7	[116.5]	3	[350.]
INT Z ANG P (L4)	0.68	13.7	9.3	24	223.
J APP PHYSI (L4)	1.90	16.2	30.8	301	9259.
J GEN PHYSI (L4)	4.50	24.2	109.0	92	10026.
J PHYSI LON (L4)	4.01	27.1	108.5	307	33322.
J PHYSI PAR (L4)	0.33	46.1	15.1	58	875.
JAP J PHYSI (L4)	1.22	19.7	24.0	35	840.
PFLUG ARCH (L4)	1.20	20.0	23.9	244	5841.
PHYSIOL REV (L4)	0.78	309.5	242.4	18	4364.
PHYSI BOHEM (L4)	0.19	21.3	4.1	107	443.
Q J EXP PHY (L4)	2.24	17.0	38.1	32	1220.
REV ESP FIS (L4)	0.09	11.4	1.0	42	44.
ANATOMY & MORPHOLOGY					
ACT ANATOM (L4)	0.49	15.7	7.7	136	1046.
ACT MORPH H (L4)	0.25	21.1	5.4	31	167.
ACT MORPH N (L4)	0.17	14.4	2.4	37	90.
AM J ANAT (L4)	1.47	22.4	33.0	99	3267.
ANAT REC (L4)	2.26	22.0	49.7	106	5266.
ARCH ANAT M (L4)	0.68	26.1	17.6	26	458.
BIBL ANATOM (L4)		0.0		0	
J ANAT (L4)	1.97	18.8	37.0	79	2927.
J MORPH (L4)	0.91	21.4	19.5	89	1735.
EMBRYOLOGY					
CELL DIFFER (L4)	0.39	15.5	6.0	26	157.
DEVELOP BIO (L4)	0.66	24.3	16.1	233	3754.
DEVELOP GR (L4)	0.49	16.0	7.8	24	188.
GROWTH (L4)	0.60	15.4	9.3	40	372.
J EMB EXP M (L4)	0.80	19.3	15.4	100	1543.
TERATOLOGY (L4)	0.22	17.9	3.9	69	270.
W ROUX ARCH (L4)	0.71	19.8	14.0	50	698.
Z ANAT ENTW (L4)	0.34	21.0	7.1	69	487.
GENETICS & HEREDITY					
ACT GENET M (L2)	0.32	15.7	5.1	17	86.
ADV GENETIC (L4)	0.31	245.2	76.2	6	457.
ADV HUM GEN (L3)		0.0		0	
AM J HU GEN (L3)	1.97	14.9	29.3	59	1729.
ANN GENET (L2)	0.59	12.6	7.5	48	358.
ANN HUM GEN (L3)	2.10	14.1	30.7	41	1261.
ANN R GENET (L4)	0.51	131.6	66.6	10	666.
ATT ASS GEN (L4)		0.5		83	
B EUR S HUM (L3)		6.1		24	
BIOCHEM GEN (L4)	0.71	16.7	11.9	101	1202.
CAN J GENET (L4)	0.52	13.0	6.7	103	693.
CHROMOSOMA (L4)	1.30	19.4	25.3	135	3410.
CLIN GENET (L2)	0.27	10.8	3.0	72	213.
CYTOG C GEN (L4)	1.69	13.8	23.4	43	1005.

JOURNAL ASSIGNMENTS & INFLUENCE MEASURES (1973 DATA)
31-JAN-75

		INFL WT	REFS /PUB	INFL /PUB	PUBS	TOT INFL
BIOMEDICAL RESEARCH (CONTINUED)						
GENETICS & HEREDITY (CONTINUED)						
EVOLUTION	(L4)	1.75	15.9	27.8	70	1949.
GENET IBER	(L4)		10.0		9	
GENET POL	(L4)	0.09	5.6	0.5	30	14.
GENET RES	(L4)	1.87	12.9	24.0	57	1368.
GENETICA	(L4)	0.62	11.3	6.9	47	326.
GENETICS	(L4)	1.96	19.3	37.7	178	6711.
GENETIKA	(L4)	0.10	8.8	0.9	314	286.
HEREDITAS	(L4)	0.80	16.8	13.3	93	1240.
HEREDITY	(L4)	2.55	11.8	30.1	58	1746.
HUMAN HERED	(L2)	0.77	11.1	8.6	82	704.
HUMANGENET	(L3)	0.31	15.1	4.7	186	867.
J GENET HUM	(L2)	0.24	18.6	4.5	18	80.
J GENETICS	(L4)		16.3		6	
J HEREDITY	(L4)	1.37	7.8	10.7	86	919.
J MED GENET	(L2)	0.65	14.3	9.2	74	683.
J MOL EVOL	(L4)	0.23	18.5	4.2	32	134.
JAP J GENET	(L4)	0.68	9.8	6.7	52	347.
JAP J HUM G	(L3)	0.44	12.3	5.4	19	102.
MOL G GENET	(L4)	0.58	18.4	10.7	257	2740.
MUTAT RES	(L4)	0.47	16.7	7.8	197	1535.
PROG MED GE	(L3)	0.11	186.4	20.7	7	145.
THEOR A GEN	(L4)	0.09	11.8	1.1	72	80.
THEOR POP B	(L4)	0.46	9.6	4.4	21	93.
NUTRITION & DIETETICS						
AM J CLIN N	(L4)	0.44	22.7	10.0	204	2036.
ANN NUTR AL	(L4)	0.12	19.5	2.4	11	27.
BIBL NUTR D	(L4)		0.0		0	
BR J NUTR	(L4)	0.66	17.3	11.4	99	1131.
I J NUTR D	(L4)	0.02	9.0	0.2	36	6.
INT J VIT N	(L4)	0.21	15.7	3.3	53	176.
J AM DIET A	(L4)	0.24	7.6	1.8	118	212.
J NUTR	(L4)	0.70	23.2	16.3	208	3384.
J NUTR SC V	(L4)	0.32	12.2	3.9	40	155.
NUTR METAB	(L4)	0.14	13.9	2.0	62	124.
NUTR REP IN	(L4)	0.05	10.3	0.5	101	55.
NUTR REV	(L4)	0.14	37.3	5.4	18	97.
P NUTR SOC	(L4)	0.29	29.1	8.5	33	279.
Z ERNAHRUNG	(L4)	0.14	14.7	2.1	36	76.
BIOCHEMISTRY & MOLECULAR BIOLOGY						
ACT BIO IRA	(L4)		12.2		10	
ACT BIO MED	(L4)	0.17	15.2	2.7	208	551.
ACT BIOCH H	(L4)		11.2		48	
ACT BIOCH P	(L4)	0.52	18.5	9.6	29	278.
ACT VIT ENZ	(L4)		30.9		21	
ADV ENZYM	(L4)	0.39	189.5	73.5	22	1617.
ANALYT BIOCH	(L4)	2.52	11.3	28.5	474	13533.
ANN R BIOCH	(L4)	1.00	186.0	187.0	23	4300.

JOURNAL ASSIGNMENTS & INFLUENCE MEASURES (1973 DATA)
31-JAN-75

	INFL WT	REFS /PUB	INFL /PUB	PUBS	TOT INFL
BIOMEDICAL RESEARCH (CONTINUED)					
BIOCHEMISTRY & MOLECULAR BIOLOGY (CONTINUED)					
ARCH BIOCH (L4)	1.54	22.7	34.9	569	19869.
ARCH I PHYS (L4)	0.54	13.3	7.2	101	730.
BIOC BIOP A (L4)	1.35	21.1	28.3	2253	63827.
BIOC BIOP R (L4)	2.03	13.1	26.5	1145	30365.
BIOC EX BIO (L4)		8.8		33	
BIOCHEM (L4)	1.97	25.2	49.6	832	41300.
BIOCHEM J (L4)	2.50	22.9	57.3	700	40096.
BIOCHIMIE (L4)	0.52	20.1	10.4	200	2080.
BIOKIMIYA (L4)	0.31	13.9	4.3	199	848.
BIOORG CHEM (L4)		24.7		36	
BIOPOLYMERS (L4)	1.04	22.0	22.9	210	4801.
BROOK S BIO (L4)		0.0		0	
CAN J BIOCH (L4)	0.59	20.6	12.2	235	2872.
CHEM PHYS L (L4)	1.83	16.9	31.0	53	1644.
CHEM-BIO IN (L4)	0.29	25.6	7.5	66	498.
COLD S HARB (L4)	4.50	20.6	92.7	81	7507.
CR TR LAB C (L4)	3.66	53.7	196.6	4	786.
ENZYME (L4)	0.32	17.9	5.7	58	333.
ERGEB PHYSI (L4) (40%)	[0.45]	260.7	[116.5]	3	[350.]
EUR J BIOCH (L4)	1.08	23.9	25.8	646	16647.
FEBS LETTER (L4)	1.07	13.6	14.6	718	10468.
H-S Z PHYSL (L4)	0.91	25.1	22.8	217	4945.
I J BIOCH B (L4)	0.16	13.4	2.2	86	189.
INT J BIOCH (L4)	0.11	20.3	2.3	78	178.
INT J PEPT (L4)	0.29	23.0	6.7	49	330.
ITAL J BIOC (L4)	0.81	12.7	10.2	16	164.
J BIOCHEM (L4)	0.89	19.4	17.4	341	5937.
J BIOL CHEM (L4)	3.70	26.2	97.0	1222	118497.
J LIPID RES (L4)	2.83	23.1	65.4	95	6212.
J MOL BIOL (L4)	3.32	27.0	89.7	422	37862.
J STEROID B (L4)	0.31	19.4	6.0	48	289.
J THEOR BIO (L4)	0.59	18.5	10.9	185	2011.
LIPIDS (L4)	0.75	16.2	12.1	142	1715.
MOL BIOL R (L4)	0.15	18.6	2.7	109	296.
MOL C BIOCH (L4)	0.29	33.5	9.9	38	376.
P AUST BIOC (L4)		0.0		0	
PHOTOCHEM P (L4) (60%)	[0.88]	18.6	[16.5]	134	[2209.]
PHYSL CHEM (L4)	0.34	15.2	5.1	56	286.
POST BIOCH (L4)	0.01	96.5	0.8	26	20.
PREP BIOCH (L4)	0.27	12.6	3.4	38	129.
REV RO BIOC (L4)	0.05	11.8	0.6	44	27.
SEIKAGAKU (L4)	0.24	34.6	8.2	28	230.
STEROID LIP (L4)		13.7		35	
STERIODS (L4)	1.07	14.9	16.0	135	2160.
UKR BIOKHIM (L4)	0.04	13.6	0.5	143	71.
VOP MED KH (L4)	0.09	11.9	1.1	179	195.
BIOPHYSICS					
ANN PHYS BI (L4)		6.3		11	

JOURNAL ASSIGNMENTS & INFLUENCE MEASURES (1973 DATA)
31-JAN-75

	INFL WT	REFS /PUB	INFL /PUB	PUBS	TOT INFL
BIOMEDICAL RESEARCH (CONTINUED)					
BIOPHYSICS (CONTINUED)					
ANN R BIOPH (L4)	0.04	108.1	4.7	30	141.
B MATH BIOL (L4)		11.5		33	
B MATH BIOP (L4)	1.65	11.6	19.0	18	342.
BIOFIZIKA (L4)	0.38	9.5	3.6	157	570.
BIOPHYS J (L4)	2.26	15.8	35.7	94	3354.
BIOPHYSIK (L4)	0.17	13.9	2.3	61	142.
J BIOENERG (L4)	0.17	27.2	4.7	45	209.
J BIOMECHAN (L4)	0.37	9.3	3.4	69	235.
Q REV BIOPH (L4)	1.57	79.6	124.6	5	623.
STUD BIOPHY (L4)	0.08	9.9	0.7	167	122.
CELL BIOLOGY CYTOLOGY & HISTOLOGY					
ACT CYTOL (L2)	0.48	11.0	5.2	81	424.
ACT HISTOCH (L4)	0.24	21.1	5.1	106	543.
ANN HISTOCH (L4)	0.20	15.1	3.0	30	89.
CALCIF TISS (L3)	0.43	16.4	7.0	90	629.
CARYOLOGIA (L4)	0.50	10.1	5.0	53	267.
CELL TISS K (L4)	0.59	18.4	10.8	56	605.
CYTOBIOLOG (L4)	0.26	20.8	5.3	54	288.
CYTOBIOS (L4)	0.19	21.8	4.1	41	167.
CYTOLOGIA (L4)	0.39	12.1	4.8	101	483.
EXP CELL RE (L4)	1.43	19.9	28.4	450	12793.
HISTOCHEM J (L4)	0.20	22.7	4.5	53	238.
HISTOCHEMIE (L4)	0.44	21.7	9.6	167	1597.
IN VITRO (L4)	0.46	17.7	8.2	57	467.
INT REV CYT (L4)	0.41	166.9	68.0	22	1496.
J CELL BIOL (L4)	3.04	29.5	89.9	312	28046.
J CELL PHYS (L4)	1.93	21.5	41.7	109	4543.
J CELL SCI (L4)	1.27	21.9	27.8	114	3168.
J HIST CYTO (L4)	1.71	28.6	48.9	109	5327.
J MEMBR BIO (L4)	0.84	20.0	16.7	80	1340.
J SUBMIC CY (L4)	0.25	22.4	5.7	17	97.
J ULTRA RES (L4)	1.82	23.3	42.5	128	5437.
NUCLEUS (L4)	0.25	12.4	3.1	37	115.
PROTOPLASMA (L4)	0.72	17.5	12.7	112	1422.
STAIN TECH (L4)	5.15	5.1	26.4	65	1715.
SUB-CELL BI (L4)		0.0		0	
TISSUE CELL (L4)	0.51	17.7	9.1	49	443.
TSITOLOGIYA (L4)	0.09	14.5	1.4	273	377.
Z ZELL MIKR (L4)	0.66	27.1	18.3	390	7149.
MICROBIOLOGY					
A VAN LEEUW (L4)	0.44	13.3	5.8	76	439.
ACT MICRO H (L4)	0.29	8.5	2.5	63	156.
ACT MICRO P (L4)	0.16	10.0	1.6	43	70.
ANN MICROB (L4)		0.0		0	
ANN R MICRO (L4)	0.48	138.1	66.2	21	1389.
APPL MICROB (L4)	0.59	10.0	5.9	471	2784.
ARCH MIKROB (L4)	0.52	15.8	8.2	214	1759.

JOURNAL ASSIGNMENTS & INFLUENCE MEASURES (1973 DATA)
31-JAN-75

	INFL WT	REFS /PUB	INFL /PUB	PUBS	TOT INFL
BIOMEDICAL RESEARCH (CONTINUED)					
MICROBIOLOGY (CONTINUED)					
BACT REV (L4)	0.72	182.7	132.0	21	2772.
BIBL MICROB (L4)		0.0		0	
CAN J MICRO (L4)	0.47	14.8	7.0	242	1701.
FOL MICROB (L4)	0.37	12.8	4.7	66	311.
GIOR MICROB (L4)		0.0		0	
INT J SY B (L4)	0.26	17.5	4.6	54	248.
J APPL BACT (L4)	0.57	11.8	6.8	84	568.
J BACT (L4)	1.22	19.9	24.2	748	18139.
J GEN A MIC (L4)	0.50	13.1	6.6	41	271.
J GEN MICRO (L4)	1.02	17.9	18.3	278	5082.
J MED MICRO (L3)		0.0		0	
JAP J MICRO (L4)	0.25	14.0	3.5	79	276.
MICROBIOS (L4)	0.17	14.4	2.5	51	127.
MIKROBIOLOG (L4)	0.25	8.6	2.1	202	432.
Z ALLG MIKR (L4)	0.12	13.4	1.5	87	134.
ZBL BAKT (L4)	0.27	10.7	2.9	267	764.
VIROLOGY					
ACT VIROLOG (L4)	0.41	11.1	4.5	80	362.
ARCH G VIR (L4)	0.38	13.4	5.1	164	836.
J GEN VIROL (L4)	0.50	18.3	9.1	208	1693.
J VIROLOGY (L4)	0.73	21.3	15.5	386	5991.
PROG MED VI (L3)		0.0		0	
VIROLOGY (L4)	1.59	19.7	31.3	409	12785.
VOP VIRUSOL (L4)	0.08	12.0	1.0	159	159.
PARASITOLOGY					
EXP PARASIT (L4)	0.60	17.0	10.1	98	994.
J HELMINTH (L4)	0.74	8.4	6.2	30	187.
J NEMATOL (L4)	0.17	8.2	1.4	68	95.
J PARASITOL (L4)	1.26	7.0	8.8	252	2215.
J PROTOZOOL (L4)	0.77	15.4	11.9	145	1723.
NEMATOLOGIC (L4)	0.58	7.1	4.1	51	211.
P HELM SOC (L4)	0.15	10.1	1.5	131	203.
PARASITOL (L4)	1.05	11.6	12.5	76	947.
Z PARASITEN (L4)	0.24	14.8	3.5	65	228.
BIOMEDICAL ENGINEERING					
ANN BIOMED (L3)		9.6		24	
BIO-MED ENG (L2)	0.28	5.5	1.5	49	75.
BIOTECH BIO (L4)	0.50	13.8	7.0	81	564.
COMPUT BIOM (L3)	0.70	8.0	5.6	51	287.
ERGONOMICS (L3)	0.42	7.9	3.3	59	194.
IEEE BIOMED (L3)	0.40	6.6	2.6	93	245.
J BIOMED MR (L2)	0.26	8.9	2.3	64	148.
KYBERNETIK (L4)	0.60	12.3	7.4	48	356.
MED BIO ENG (L3)	0.35	5.5	1.9	129	249.
MED RES ENG (L3)		6.3		9	

JOURNAL ASSIGNMENTS & INFLUENCE MEASURES (1973 DATA)
31-JAN-75

	INFL WT	REFS /PUB	INFL /PUB	PUBS	TOT INFL
BIOMEDICAL RESEARCH (CONTINUED)					
MICROSCOPY					
J ELEC MICR (L4)	0.29	12.3	3.6	47	168.
J MICROSC (L4)	0.82	15.5	12.7	188	2384.
J MICROSC O (L4)		0.0		0	
J MICROSCOP (L4)		0.0		0	
MICROSCOPE (L4)		3.4		17	
MIKROSKOPIE (L4)	0.35	9.5	3.3	35	115.
REV MICR EL (L4)		14.6		8	
T AM MICROS (L4)	0.40	10.6	4.2	77	326.
MISCELLANEOUS BIOMEDICAL RESEARCH					
AM J MED TE (L2)	0.17	10.6	1.8	67	120.
CAN J MED T (L2)		14.6		25	
G FIS SANIT (L3)		1.9		15	
HEALTH LAB (L2)	0.49	9.8	4.8	31	148.
HEALTH PHYS (L4)	0.59	8.5	5.0	153	771.
HUMAN BIOL (L3)	1.00	10.3	10.3	38	392.
J BIOL PHOT (L1)		3.9		30	
J BIOSOC SC (L1)	0.23	6.1	1.4	29	41.
J FOR SCI (L3)	1.28	3.9	4.9	36	178.
J MED EDUC (L1)	0.78	2.9	2.3	191	441.
LAB ANIM SC (L3)	0.39	8.0	3.1	148	459.
MED BIO ILL (L2)		1.1		32	
MED LAB TEC (L3)	0.34	5.9	2.0	61	124.
MED SCI SPT (L3)	0.09	14.3	1.3	44	58.
MET INF MED (L1)	0.19	6.5	1.2	34	41.
PHYS MED BI (L3)	0.96	11.2	10.7	69	738.
SOCIAL BIOL (L1)	0.36	7.1	2.6	62	160.
Z RECHTSMED (L2)	0.11	12.5	1.3	89	119.
GENERAL BIOMEDICAL RESEARCH*					
ACT BIOL H (L4)	0.86	14.6	12.6	21	264.
ACT CIENT V (L4) (63%)	[0.03]	15.4	[0.5]	78	[37.]
AM SCIENT (L4) (45%)	[0.66]	14.2	[9.3]	50	[465.]
AN AC BRASI (L4) (32%)	[0.18]	9.2	[1.6]	84	[138.]
ANN NY ACAD (L4) (75%)	[1.28]	15.9	[20.5]	616	[12610.]
ARCH I BIOL (L4)		10.5		8	
ARCH IT BIO (L4)	1.30	35.1	45.7	18	822.
ARCH SCI (L4) (15%)	[1.37]	3.6	[4.9]	16	[78.]
ATT ANL R F (L4) (15%)	[0.47]	14.0	[6.6]	56	[371.]
AUST J SCI (L4) (10%)	[0.79]	15.2	[12.1]	568	[6860.]
B AC POL SC (L4) (15%)	[0.49]	4.9	[2.4]	661	[1586.]
B CSAR BELG (L4) (5%)	[0.14]	6.9	[1.0]	66	[63.]
B ITAL BIOL (L4)	0.24	5.9	1.4	304	435.
B NJ ACAD S (L4) (40%)		0.0		0	
B POL BIOL (L4)		0.0		0	
B RES C ISR (L4) (60%)	[0.36]	12.4	[4.5]	461	[2074.]
BIOL REV (L4)	0.89	115.5	102.9	16	1647.

*See Note on p. A-15

JOURNAL ASSIGNMENTS & INFLUENCE MEASURES (1973 DATA)
31-JAN-75

			INFL WT	REFS /PUB	INFL /PUB	PUBS	TOT INFL
BIOMEDICAL RESEARCH (CONTINUED)							
GENERAL BIOMEDICAL RESEARCH (CONTINUED)							
BIOSCIENCE	(L4)		0.63	11.2	7.1	59	418.
CR AC SCI	(L4)	(20%)	[1.46]	4.9	[7.2]	3251	[23505.]
CR AC SCI D	(L4)	(80%)		0.0		0	
CR SOC BIOL	(L4)		1.10	6.6	7.2	428	3088.
CR SOC PHYS	(L4)	(10%)		2.6		5	
CURRENT SCI	(L4)	(25%)	[0.37]	5.0	[1.9]	434	[807.]
DAN BOLG	(L4)	(30%)	[0.13]	4.4	[0.6]	473	[265.]
DAN BSSR	(L4)	(15%)	[0.14]	2.8	[0.4]	296	[118.]
DAN SSSR	(L4)	(20%)	[1.52]	5.0	[7.5]	2307	[17395.]
ENDEAVOUR	(L4)	(20%)	[0.77]	17.1	[13.2]	21	[277.]
EXPERIENTIA	(L4)	(90%)	[0.60]	9.1	[5.4]	995	[5423.]
FED PROC	(L4)		3.13	35.0	109.7	150	16455.
FOL BIOL	(L4)		0.50	14.7	7.3	72	524.
I J EX BIOL	(L4)		0.09	10.8	1.0	191	182.
IAN SSS BIO	(L4)			0.0		0	
IAN SSSR	(L4)	(5%)	[0.67]	10.0	[6.6]	1444	[9588.]
IMPACT SCI	(L4)	(40%)		3.6		18	
J FRANKL I	(L4)	(5%)	[1.13]	5.7	[6.5]	73	[473.]
J INDIAN I	(L4)	(5%)	[0.96]	4.4	[4.2]	14	[59.]
J INTERD CY	(L4)	(30%)	[0.11]	8.4	[0.9]	44	[40.]
J RS NZ	(L4)	(5%)		0.0		0	
J SCI LAB D	(L4)	(80%)		7.0		1	
LIFE SCI	(L4)		0.96	15.7	15.1	297	4472.
NATURE	(L4)	(80%)	[2.82]	11.6	[32.6]	2397	[78070.]
NATURE-BIOL	(L4)	(80%)		0.0		0	
NATURWISSEN	(L4)	(50%)	[1.98]	7.8	[15.4]	242	[3734.]
NZ J SCI	(L4)	(5%)	[0.41]	10.7	[4.4]	76	[338.]
P I A SCI B	(L4)	(5%)	[1.90]	7.0	[13.3]	74	[982.]
P JAF ACAD	(L4)	(20%)	[1.56]	4.7	[7.3]	179	[1305.]
P KON NED	(L4)	(40%)	[0.61]	7.9	[4.9]	112	[544.]
P KON NED C	(L4)	(40%)		0.0		0	
P NAS IND	(L4)	(30%)		0.0		0	
P NAS IND B	(L4)	(60%)		0.0		0	
P NAS US	(L4)	(87%)	[3.15]	18.6	[58.6]	789	[46243.]
P R IR AC	(L4)	(10%)	[0.86]	9.8	[8.4]	34	[285.]
P R IR AC B	(L4)	(20%)		0.0		0	
P ROY SOC	(L4)	(14%)	[8.16]	15.8	[129.0]	191	[24635.]
P ROY SOC B	(L4)	(70%)		0.0		0	
P RS EDIN	(L4)	(25%)	[3.23]	4.9	[15.9]	20	[317.]
P RS EDIN B	(L4)	(50%)		0.0		0	
PAC SCI	(L4)	(10%)	[1.00]	7.7	[7.7]	26	[200.]
PER BIOL	(L4)			9.1		47	
PHI T ROY	(L4)	(40%)	[2.14]	13.4	[28.6]	169	[4835.]
PHI T ROY A	(L4)	(80%)		0.0		0	
Q REV BIOL	(L4)		1.61	38.2	61.4	17	1044.
RECHERCHE	(L4)	(30%)	[0.07]	13.1	[0.9]	32	[30.]
REV CAN BIO	(L4)		0.47	20.0	9.4	30	283.
SCI AM	(L4)	(25%)		0.9		95	
SCI FORUM	(L4)	(80%)		0.1		28	
SCI PROGR	(L4)	(20%)	[0.21]	31.8	[6.7]	19	[127.]
SCI STUD	(L4)	(10%)		1.0		8	

JOURNAL ASSIGNMENTS & INFLUENCE MEASURES (1973 DATA)
31-JAN-75

			INFL WT	REFS /PUB	INFL /PUB	PUBS	TOT INFL
BIOMEDICAL RESEARCH (CONTINUED)							
GENERAL BIOMEDICAL RESEARCH (CONTINUED)							
SCIENCE	(L4)	(50%)	[3.29]	13.9	[45.7]	1016	[46482.]
SCIENTIA	(L4)	(20%)		2.4		17	
SEARCH	(L4)	(20%)	[0.25]	5.1	[1.3]	66	[84.]
SOV SCI REV	(L4)	(30%)		6.1		7	
T NY AC SCI	(L4)	(25%)	[1.10]	18.1	[20.0]	34	[680.]
T ROY SOC C	(L4)	(10%)		2.8		12	
T RS S AFR	(L4)	(25%)		8.9		10	
T WISC AC	(L4)	(20%)		0.0		0	
T-I-T-J LIF	(L4)			12.0		11	
TEXAS J SCI	(L4)	(20%)	[0.39]	7.3	[2.9]	22	[63.]
VAN SSSR	(L4)	(5%)		0.0		0	
Z NATURFO	(L4)	(20%)	[1.17]	12.7	[14.8]	599	[8865.]
Z NATURFO B	(L4)			0.0		0	
Z NATURFO C	(L4)			0.0		0	

BIOLOGY

GENERAL BIOLOGY *

ACT BIO CRA			0.28	11.1	3.1	37	115.
ACT CIENT V	(2%)		[0.03]	15.4	[0.5]	78	[37.]
AM BIOL TEA				1.5		85	
AM SCIENT	(10%)		[0.66]	14.2	[9.3]	50	[465.]
AN AC BRASI	(15%)		[0.18]	9.2	[1.6]	84	[138.]
ANN NY ACAD	(5%)		[1.28]	15.9	[20.5]	616	[12610.]
ARCH SCI	(10%)		[1.37]	3.6	[4.9]	16	[78.]
ARCTIC	(50%)		[0.76]	3.4	[2.6]	38	[100.]
ATT ANL R F	(10%)		[0.47]	14.0	[6.6]	56	[371.]
AUST J BIOL				0.0		0	
AUST J SCI	(60%)		[0.79]	15.2	[12.1]	568	[6860.]
B AC POL SC	(15%)		[0.49]	4.9	[2.4]	661	[1586.]
B CSAR BELG	(5%)		[0.14]	6.9	[1.0]	66	[63.]
B NJ ACAD S	(40%)			0.0		0	
B RES C ISR	(10%)		[0.36]	12.4	[4.5]	461	[2074.]
BIOL J LINN			0.55	16.7	9.1	57	521.
CR AC SCI	(5%)		[1.46]	4.9	[7.2]	3251	[23505.]
CR AC SCI D	(20%)			0.0		0	
CR SOC PHYS	(30%)			2.6		5	
CURRENT SCI	(15%)		[0.37]	5.0	[1.9]	434	[807.]
DAN BOLG	(10%)		[0.13]	4.4	[0.6]	473	[265.]
DAN BSSR	(5%)		[0.14]	2.8	[0.4]	296	[118.]
DAN SSSR	(5%)		[1.52]	5.0	[7.5]	2307	[17395.]
ENDEAVOUR	(15%)		[0.77]	17.1	[13.2]	21	[277.]
EXPERIENTIA	(5%)		[0.60]	9.1	[5.4]	395	[5423.]
IAN SSSR	(2%)		[0.67]	10.0	[6.6]	1444	[9563.]
IMPACT SCI	(20%)			3.6		18	
J EXP BIOL			2.81	18.1	51.0	111	5656.
J FAC TOK 1	(2%)			5.7		8	
J FRANKL I	(5%)		[1.13]	5.7	[6.5]	73	[473.]
J INDIAN I	(10%)		[0.96]	4.4	[4.2]	14	[59.]
J INTERD CY	(20%)		[0.11]	8.4	[0.9]	44	[40.]
J RS NZ	(45%)			0.0		0	

*See Note on p. A-15

JOURNAL ASSIGNMENTS & INFLUENCE MEASURES (1973 DATA)
31-JAN-75

		INFL WT	REFS /PUB	INFL /PUB	PUBS	TOT INFL
BIOLOGY (CONTINUED)						
GENERAL BIOLOGY (CONTINUED)						
J SCI LAB D	(20%)		7.0		1	
NATURE	(1%) [2.82]	11.6	[32.6]	2397	[78070.]	
NATURE-BIOL	(20%)	0.0		0		
NATURWISSEN	(5%) [1.98]	7.8	[15.4]	242	[3734.]	
NZ J SCI	(35%) [0.41]	10.7	[4.4]	76	[338.]	
P I A SCI B	(80%) [1.90]	7.0	[13.3]	74	[982.]	
P JAP ACAD	(5%) [1.56]	4.7	[7.3]	179	[1305.]	
P KON NED C	(60%)	0.0		0		
P NAS IND	(20%)	0.0		0		
P NAS IND B	(40%)	0.0		0		
P NAS US	(4%) [3.15]	18.6	[58.6]	789	[46243.]	
P R IR AC	(15%) [0.86]	9.8	[8.4]	34	[285.]	
P R IR AC B	(30%)	0.0		0		
P ROY SOC	(6%) [8.16]	15.8	[129.0]	191	[24635.]	
P ROY SOC B	(30%)	0.0		0		
P RS EDIN	(25%) [3.23]	4.9	[15.9]	20	[317.]	
P RS EDIN B	(50%)	0.0		0		
PAC SCI	(70%) [1.00]	7.7	[7.7]	26	[200.]	
PHI T ROY	(10%) [2.14]	13.4	[28.6]	169	[4835.]	
PHI T ROY A	(20%)	0.0		0		
RADIOCARBON	(40%) [1.26]	5.2	[6.6]	46	[302.]	
RECHERCHE	(10%) [0.07]	13.1	[0.9]	32	[30.]	
SCI AM	(20%)	0.9		95		
SCI FORUM	(20%)	0.1		28		
SCI PROGR	(20%) [0.21]	31.8	[6.7]	19	[127.]	
SCI STUD	(10%)	1.0		8		
SCIENCE	(15%) [3.29]	13.9	[45.7]	1016	[46482.]	
SCIENTIA	(10%)	2.4		17		
SEARCH	(20%) [0.25]	5.1	[1.3]	66	[84.]	
SOV SCI REV	(10%)	6.1		7		
T NY AC SCI	(10%) [1.10]	18.1	[20.0]	34	[680.]	
T ROY SOC C	(40%)	2.8		12		
T RS S AFR	(35%)	8.9		10		
T WISC AC	(65%)	0.0		0		
TEXAS J SCI	(35%) [0.39]	7.3	[2.9]	22	[63.]	
VIE MILIE	(50%) [0.61]	6.8	[4.2]	63	[264.]	
VIE MILIE C		0.0		0		
GENERAL ZOOLOGY						
ACT BIO C Z		0.0		0		
ACT ZOOL H		2.4		18		
AM ZOOLOG		0.60	36.1	21.6	72	1556.
ANN ZOOTECH		0.17	9.5	1.7	39	65.
B I ZOOL AS			10.7		12	
CAN J ZOOL		0.94	13.2	12.4	169	2089.
ISR J ZOOL		0.31	6.7	2.1	24	50.
J EXP ZOOL		2.18	30.4	44.5	128	5697.
J ZOOL		1.27	13.2	16.7	90	1500.
JAP J ZOOL			2.5		2	

JOURNAL ASSIGNMENTS & INFLUENCE MEASURES (1973 DATA)
31-JAN-75

	INFL WT	REFS /PUB	INFL /PUB	PUBS	TOT INFL
BIOLOGY (CONTINUED)					
GENERAL ZOOLOGY (CONTINUED)					
P AC NAT S	0.61	22.0	13.5	7	94.
SYST ZOOLOG	1.56	13.1	20.5	37	758.
Z WISS ZOOLOG	1.47	17.8	26.2	25	655.
ZOOLOG J LINN		0.0		0	
ZOOLOG SCR		0.0		0	
ZOOLOGICA	2.72	7.6	20.7	15	310.
ENTOMOLOGY					
ACT ENT BOH	0.16	5.6	0.9	51	45.
ANN ENT S A	1.01	7.0	7.1	291	2063.
ANN R ENTOM	0.45	91.1	40.9	17	695.
ANN SOC ENT	0.35	6.8	2.4	42	101.
B ENT RES	0.63	20.0	12.5	46	577.
CAN ENTOMOL	1.04	6.7	7.0	171	1195.
ENT EXP APP	1.08	8.7	9.3	46	429.
INSECT BIOG	0.08	18.6	1.5	43	64.
INSECT SOC	0.44	7.1	3.1	27	84.
J ECON ENT	2.11	5.2	10.9	526	5744.
J ENTOMOL	0.73	6.2	4.6	46	211.
J INSECT PH	1.07	13.9	14.9	224	3344.
J MED ENT	0.40	7.9	3.2	123	387.
J NY ENT SO	0.47	4.7	2.2	37	81.
MEN ENT S C		4.7		3	
MOSQUITO NE	0.64	9.4	6.0	105	629.
P ENT S ONT	0.28	6.8	1.9	23	44.
P ENT S WAS	1.15	1.1	1.2	92	115.
P HAWAII EN		4.6		14	
PAC INSECTS		2.4		35	
PAN PAC ENT	0.58	1.9	1.1	61	66.
T ROY ENT S	1.42	11.6	16.4	16	262.
MISCELLANEOUS ZOOLOGY					
ANN BIOL AN	0.45	17.0	7.7	52	399.
ARDEA-T NED	0.42	10.6	4.5	16	72.
AUK	1.28	5.3	6.8	112	760.
BIBL PRIMAT		0.0		0	
BIRD BAND	0.67	6.2	4.2	36	149.
BIRD STUDY	1.00	5.5	5.4	22	119.
COMP BIOCH	0.79	17.0	13.4	646	8643.
CONDOR	1.16	7.1	8.2	101	832.
COPEIA	1.06	6.3	6.6	162	1074.
FOL PRIMAT	0.19	10.0	2.0	48	94.
IBIS	1.66	9.2	15.2	41	624.
J COMP PHYS	0.50	16.2	8.1	207	1673.
J INVER PAT	0.82	7.9	6.5	162	1048.
J MAMMAL	1.13	7.3	8.3	134	1111.
J MED PRIM		8.7		31	
PHYSL ZOOLOG	2.22	15.2	33.9	28	950.
PRIMATOLOG		0.0		0	

JOURNAL ASSIGNMENTS & INFLUENCE MEASURES (1973 DATA)
31-JAN-75

	INFL WT	REFS /PUB	INFL /PUB	PUBS	TOT INFL
BIOLOGY (CONTINUED)					
MISCELLANEOUS ZOOLOGY (CONTINUED)					
WILSON B	0.90	4.8	4.3	77	335.
Z MORPH TIE	0.66	12.4	8.2	45	370.
MARINE BIOLOGY & HYDROBIOLOGY					
ADV MAR BIO	0.09	205.2	19.5	4	78.
ARCH FISCH		4.2		26	
AUST J MAR	0.63	10.3	6.5	19	124.
B JAP S S F	0.47	6.4	3.0	172	521.
BIOL B	2.64	17.4	46.0	79	3636.
BOTAN MARIN	0.37	8.5	3.2	28	88.
CAN BIO MAR	0.18	8.6	1.5	44	66.
CAN ORST HY		0.0		0	
CAN ORSTOM	(50%) [0.47]	11.2	[5.3]	30 [159.]
FISH B	0.28	9.4	2.7	86	230.
HYDROBIOL	0.27	9.2	2.5	87	220.
J FISH BIOL	0.10	8.8	0.9	80	74.
J FISH RES	1.07	7.6	8.2	293	2397.
J MARINE BI	2.73	12.9	35.3	70	2470.
MAR FISH RE		0.5		6	
MARINE BIOL	0.23	12.1	2.7	233	636.
PROG FISH-C	1.98	3.1	6.1	38	231.
SARSIA	1.42	7.0	9.9	24	238.
T AM FISH S	0.68	5.8	3.9	119	468.
VIE MILIE A		0.0		0	
BOTANY					
ACT BIO C B		0.0		0	
ACT BOT NEE	0.78	10.8	8.4	65	548.
AM J BOTANY	2.73	14.0	38.1	129	4920.
ANN A PLANT	0.29	6.7	1.9	20	39.
ANN BOTANY	1.33	12.0	16.0	136	2171.
ANN MO BOT	0.49	8.0	4.0	33	131.
ANN R PHYTO	0.28	71.5	19.8	21	416.
ANN R PLANT	0.87	164.7	142.4	20	2848.
AUST J BOT	1.32	8.0	10.5	21	220.
B S BOT FR	0.20	8.5	1.7	112	194.
B TOR BOT C	1.50	6.4	9.6	49	472.
BER DEU BOT	0.58	12.5	7.2	97	700.
BIOL PLANT	0.14	9.0	1.3	68	88.
BOTAN B A S	0.09	10.1	0.9	16	15.
BOTAN GAZ	1.60	11.5	18.4	75	1082.
BOTAN J LIN		0.0		0	
BOTAN MAG	3.09	8.3	25.6	30	769.
BOTAN NOTIS	0.55	8.0	4.4	51	225.
BOTAN REV	0.78	93.0	72.7	10	727.
BOTAN TIDS	0.34	5.6	1.9	18	35.
BRITTONIA	1.16	3.9	4.5	28	127.
CAN J BOTAN	0.96	12.6	12.1	250	3093.
COM FOR REV		1.1		14	

JOURNAL ASSIGNMENTS & INFLUENCE MEASURES (1973 DATA)
31-JAN-75

	INFL WT	REFS /PUB	INFL /PUB	PUBS	TOT INFL
BIOLOGY (CONTINUED)					
BOTANY (CONTINUED)					
DANSK BOTAN		63.0		1	
ECON BOTAN	0.23	13.0	3.0	54	160.
FLORA	1.03	11.7	12.0	32	383.
FOREST CHRO	0.64	3.0	1.9	33	64.
FOREST SCI	2.23	4.0	9.0	48	432.
FORESTRY		4.3		10	
HORT RES		3.7		15	
HORTICULT		0.0		26	
ISR J BOT		0.0		0	
J AM S HORT	0.99	8.9	8.8	166	1467.
J ARN ARBOR	0.73	11.5	8.4	19	159.
J BRYOL	0.40	5.8	2.3	20	46.
J EXP BOT	1.84	15.2	28.0	98	2749.
J FORESTRY	3.69	1.5	5.4	98	531.
J HORT SCI	0.80	7.5	6.0	45	270.
J PHYCOLOGY	0.81	14.0	11.3	66	748.
JAP J BOTAN		13.5		2	
LLOYDIA	1.14	24.6	27.9	48	1340.
MEDD NOR SK		0.0		0	
MITT B FORS		7.3		26	
MYCOLOGIA	0.91	8.6	7.8	142	1113.
MYCOP MYC A	0.21	11.2	2.3	95	223.
NEW PHYTOL	0.79	15.2	12.1	158	1909.
OSTER BOT Z	0.39	8.1	3.2	35	111.
PHOTOSYNTH	0.47	12.5	5.9	44	260.
PHYSL PL P	0.28	13.4	3.8	55	208.
PHYSL PLANT	1.32	15.3	20.2	179	3614.
PHYSL VEGET	0.78	24.5	19.1	35	688.
PHYTOCHEM	1.14	12.4	14.2	648	9215.
PHYTOMA		0.3		26	
PHYTOMORPH	1.39	10.8	15.0	25	375.
PHYTON		13.2		5	
PHYTON AUST		10.1		13	
PHYTOPATHOL	1.29	10.0	12.9	501	6468.
PLANT CEL P	1.00	14.6	14.6	134	1954.
PLANT DIS R	1.57	3.9	6.2	306	1888.
PLANT PATH	2.12	3.2	6.9	44	303.
PLANT PHYSL	2.87	17.9	51.2	401	20527.
PLANT SOIL	0.57	8.3	4.7	147	697.
PLANTA	2.19	15.1	32.9	218	7179.
PLANTA MED	0.70	9.3	6.4	103	664.
RADIAT BOT	0.48	14.4	6.9	45	310.
REV PALAE P		5.8		16	
SABOURAUDIA	0.35	9.3	3.2	51	163.
SCI HORT		4.7		21	
SYM BOT UPS		0.0		0	
T BR MYCOL	0.87	8.1	7.0	146	1019.
Z PFLANZENP	0.68	14.0	9.5	134	1268.
Z PFLANZENZ	0.21	10.9	2.3	62	144.

JOURNAL ASSIGNMENTS & INFLUENCE MEASURES (1973 DATA)
31-JAN-75

	INFL WT	REFS /PUB	INFL /PUB	PUBS	TOT INFL
BIOLOGY (CONTINUED)					
BOTANY (CONTINUED)					
ECOLOGY					
AM MIDL NAT	0.64	8.8	5.6	126	703.
AM NATURAL	1.54	15.8	24.3	57	1387.
CALIF FISH	2.41	4.0	9.6	37	355.
ECOL MONOGR	0.91	31.3	28.5	28	797.
ECOLOGY	1.35	12.4	16.8	178	2956.
INV PESQ		4.9		19	
J ANIM ECOL	1.24	13.1	16.3	47	766.
J APPL ECOL	0.44	11.4	5.0	76	382.
J BR GRASSL	1.71	8.1	13.8	31	428.
J ECOLOGY	1.43	12.8	18.4	61	1121.
J NAT HIST	1.11	5.0	5.6	51	283.
J WILDL MAN	1.00	6.0	6.0	119	709.
NATURAL CAN		0.0		0	
NATURAL HI		0.3		45	
OECO PLANTA	0.11	9.9	1.0	27	28.
DECOLOGIA	0.14	13.9	2.0	76	148.
OIKOS	0.73	10.3	7.5	63	472.
USBSFW R		0.0		0	
AGRICULTURE & FOOD SCIENCE					
ACT AGRON H	0.03	5.8	0.2	63	11.
AG CHEM		0.0		2	
AGR BIOL CH	0.62	11.7	7.2	534	3845.
AGR ECON RE		1.9		10	
AGR EDUC NA		0.1		133	
AGR ENG		0.1		54	
AGR HOR GEN		1.3		3	
AGR METEOR	0.63	6.0	3.8	46	176.
AGR RES		0.0		0	
AGR SCI REV		5.5		10	
AGROCHIMICA	0.09	19.3	1.6	43	76.
AGRON J	1.18	7.2	8.6	298	2580.
AM J AGR EC	0.67	2.9	1.9	155	299.
AM J ENGL V	0.29	7.0	2.1	30	62.
AM POTATO J	0.74	7.1	5.2	45	235.
ANN AGRON	0.08	16.9	1.3	32	42.
ANN TEC AGR	0.04	10.8	0.4	42	18.
AUST J AGR	1.18	12.1	14.3	89	1274.
AUST J SOIL	0.78	10.3	8.0	27	215.
B ENVIR CON	0.70	6.3	4.4	136	596.
CALIF AGR		0.0		61	
CAN FARM EC		0.2		19	
CAN I FOOD	0.10	13.3	1.3	76	98.
CAN J AGR S	0.59	7.5	4.4	380	1676.
CAN J PLANT		0.0		0	
CAN J SOIL		0.0		0	
CEREAL CHEM	1.45	10.9	15.9	105	1666.

JOURNAL ASSIGNMENTS & INFLUENCE MEASURES (1973 DATA)
31-JAN-75

	INFL WT	REFS /PUB	INFL /PUB	PUBS	TOT INFL
BIOLOGY (CONTINUED)					
AGRICULTURE & FOOD SCIENCE (CONTINUED)					
CEREAL SCI	1.06	6.0	6.3	40	253.
CROP SCI	1.03	7.0	7.2	280	2027.
CROPS SOILS		0.0		23	
EUPHYTICA	0.56	8.4	4.7	80	380.
EXP AGRICUL	0.14	5.9	0.8	43	36.
FAO PLANT		3.2		22	
FARM Q		0.0		0	
FET SEI ANS	0.37	14.2	5.3	110	581.
FOOD TECHN	11.03	3.7	41.0	73	2990.
FOREIGN AGR		0.0		179	
GEODERMA	0.27	8.6	2.3	27	62.
HILGARDIA	0.73	35.5	25.8	15	387.
I J AGR SCI	0.17	3.7	0.6	158	98.
I J GENET P	0.27	6.8	1.9	69	128.
IIRB		4.5		11	
INT J A AFF		1.0		1	
IRISH J AGR	0.27	6.9	1.9	19	36.
IRRAD ALIM		0.0		0	
ISR J AGR R	0.52	4.7	2.4	27	66.
J AGR CHE J	0.69	8.6	6.0	139	831.
J AGR ENG R	0.65	6.2	4.1	26	105.
J AGR FOOD	1.29	11.5	14.9	302	4491.
J AGR SCI	1.40	9.7	13.6	136	1846.
J AM S SUG		4.2		21	
J AUS I AGR	0.31	6.4	2.0	48	95.
J FERM TECH	0.35	8.2	2.9	136	392.
J FOOD SCI	0.99	10.2	10.1	343	3464.
J I BREWING	3.29	10.0	32.8	47	1542.
J ROY AGR S		13.4		7	
J SCI FOOD	1.07	10.5	11.2	186	2091.
J SOIL SCI	1.25	10.2	12.8	53	678.
J SOIL WAT	0.95	1.9	1.9	56	104.
J STORED PR	0.46	6.8	3.2	36	113.
LANDBAU VOL		5.6		54	
LANDBOUWMEC		0.1		53	
LANDTECHNIK		0.4		41	
LEBENS M IND		2.2		76	
NZ J AGR		0.1		84	
NZ J AGR RE	0.46	9.6	4.4	97	425.
PEDOBIOLOG	0.27	7.4	2.0	43	85.
PEST BIOCH	0.11	16.8	1.8	49	87.
PEST CONTROL		2.2		35	
PEST MON J	0.69	5.9	4.1	24	98.
PROCESS BIO	0.47	8.2	3.9	52	201.
QUAL PLANT	0.11	12.6	1.3	38	51.
RECLAM ERA		0.0		11	
REV ZOO AGR		3.8		9	
SOIL CONS		0.0		79	
SOIL SCI	2.66	10.8	28.7	116	3332.

JOURNAL ASSIGNMENTS & INFLUENCE MEASURES (1973 DATA)
31-JAN-75

	INFL WT	REFS /PUB	INFL /PUB	PUBS	TOT INFL
BIOLOGY (CONTINUED)					
AGRICULTURE & FOOD SCIENCE (CONTINUED)					
SOIL SCI SO	2.00	8.6	17.2	227	3969.
SOV SOIL R	0.84	5.6	4.7	99	470.
SUGAR J		1.4		21	
T ASAE	0.41	4.7	1.9	246	477.
TASM J AGR		0.3		41	
TROP AGR	0.37	4.8	1.7	55	96.
TROP SCI		0.0		0	
TURRIALBA	0.14	4.5	0.6	70	45.
WEED RES	0.33	7.7	2.6	64	164.
WEED SCI	1.14	8.2	9.4	123	1157.
Z LEBENS MIT	0.17	10.4	1.8	130	233.
ZUCKER	0.15	4.7	0.7	55	38.
DAIRY & ANIMAL SCIENCE					
AM DAIRY F		0.5		42	
ANIM PRODUC	1.10	8.1	8.9	66	589.
AUST J DAIR	0.21	7.8	1.6	23	37.
BR POULT SC	0.39	9.0	3.5	75	262.
CAN J ANIM		0.0		0	
DAIRY IND	0.35	7.2	2.5	25	62.
FEEDSTUFFS	0.51	3.6	1.8	112	204.
FOOD ENG		0.4		65	
FOOD MANUF		2.0		29	
J ANIM SCI	1.20	12.8	15.4	401	6167.
J DAIRY RES	1.26	14.8	18.6	46	857.
J DAIRY SCI	2.17	12.2	26.4	250	6605.
J MILK FOOD	0.81	10.0	8.1	109	879.
J RANGE MAN	0.39	4.8	1.8	130	239.
NETH MILK D	0.30	15.4	4.7	41	191.
POULTRY SCI	1.34	9.7	13.0	382	4974.
WORLD POULT	0.20	33.2	6.7	12	81.
MISCELLANEOUS BIOLOGY					
AM ANTHROP	3.71	5.5	20.6	35	720.
AM J P ANTH	0.38	10.0	3.8	149	561.
ANN AP BIOL	1.47	7.2	10.6	115	1216.
CRYOBIOLOGY	0.78	14.9	11.6	83	961.
CURR ANTHR	0.69	29.0	20.0	12	240.
INT BIOD B		10.1		17	
ZH OBS BIOL	0.01	14.7	0.1	84	8.
CHEMISTRY					
ANALYTICAL CHEMISTRY					
ANAL LETTER	0.40	7.2	2.9	123	353.
ANALYSIS	0.12	8.5	1.1	85	90.
ANALYST	0.82	9.7	7.9	131	1039.
ANALYT CHEM	0.75	20.9	15.6	603	9401.
ANALYT CHIM	0.51	8.9	4.5	344	1555.

JOURNAL ASSIGNMENTS & INFLUENCE MEASURES (1973 DATA)
31-JAN-75

	INFL WT	REFS /PUB	INFL /PUB	PUBS	TOT INFL
CHEMISTRY (CONTINUED)					
ANALYTICAL CHEMISTRY (CONTINUED)					
J AOAC	1.04	5.1	5.3	321	1692.
J CHROM SCI	0.94	11.9	11.2	118	1317.
J CHROMAT	0.53	10.7	5.6	631	3553.
J RAD CHEM	0.20	6.4	1.3	143	186.
J THERM ANA	0.34	9.7	3.3	45	147.
JAP ANALYST	0.02	25.9	0.5	231	119.
MICROCHEM J	0.31	7.5	2.3	86	201.
MIKROCH ACT	0.43	9.9	4.2	124	525.
TALANTA	0.49	10.1	4.9	155	763.
Z ANAL CHEM	0.76	6.4	4.9	249	1210.
ZH ANAL KH	0.15	8.4	1.3	463	602.
ORGANIC CHEMISTRY					
ANN RP CH B		0.0		0	
CARBOHY RES	0.22	14.7	3.3	361	1195.
J CHEM S P1		0.0		0	
J CHEM S P2		0.0		0	
J HETERO CH	0.29	11.0	3.2	229	733.
J ORG CHEM	0.78	17.0	13.3	1266	16812.
J ORGMET CH	0.24	21.6	5.2	798	4126.
J SYN ORG J		31.5		92	
KHIM GETERO	0.06	7.9	0.5	370	189.
OMR-ORG MAG	0.11	16.9	1.9	142	268.
ORG CH RE		0.0		0	
ORG MASS SP	0.46	12.9	5.9	158	931.
SYNTHESIS	0.14	18.5	2.6	197	512.
TETRAHEDR L	1.20	8.5	10.1	1406	14229.
TETRAHEDRON	0.67	18.6	12.5	552	6894.
ZH ORG KH	0.18	10.8	2.0	489	973.
INORGANIC & NUCLEAR CHEMISTRY					
COORD CH RE	0.16	176.8	27.6	26	719.
INORG CHEM	0.87	19.9	17.2	677	11651.
INORG NUCL	0.48	7.3	3.5	263	923.
J CHEM S DA		0.0		0	
J INORG NUC	0.47	12.1	5.6	632	3546.
REV CHIM MI	0.19	16.3	3.2	48	153.
Z ANORG A C	0.86	12.6	10.8	280	3027.
ZH NEORG KH	0.33	7.6	2.5	589	1467.
APPLIED CHEMISTRY					
ANGEW CHEM	1.64	25.1	41.1	295	12122.
ANGEW MAKRO	0.10	12.1	1.2	98	117.
CHEM IND L	1.36	6.2	8.4	282	2377.
CHEM TECH	0.19	5.9	1.1	156	175.
CHEMTECH US	0.10	8.2	0.8	85	71.
CHIM IND N	0.26	15.0	3.9	101	395.
FLUORIDE	0.08	12.1	1.0	28	27.
IND CHIM EE	0.06	37.1	2.4	48	115.

JOURNAL ASSIGNMENTS & INFLUENCE MEASURES (1973 DATA)
31-JAN-75

	INFL WT	REFS /PUB	INFL /PUB	PUBS	TOT INFL
CHEMISTRY (CONTINUED)					
APPLIED CHEMISTRY (CONTINUED)					
IND ENG CH	1.53	10.4	16.0	236	3774.
J AM LEATH	3.82	4.5	17.1	30	512.
J AM OIL CH	0.61	11.7	7.2	151	1084.
J APPL CH B	0.66	8.7	5.7	94	536.
J OIL COL C	0.53	5.3	2.8	54	150.
J PAINT TEC	1.14	5.4	6.2	65	400.
J PRAK CHEM	0.51	12.0	6.1	155	949.
J S COSM CH	0.18	15.5	2.8	61	170.
J SCI IND R	0.14	60.2	8.3	47	388.
KJEMI		0.4		44	
MANUF CH AE	0.01	55.4	0.8	7	5.
OXID COMB R		572.0		1	
PRZEMY CHEM	0.12	2.5	0.3	194	58.
RES DEVELOP	0.33	4.5	1.5	51	76.
SEP PURIF M		68.1		13	
SEPARAT SCI	0.38	11.8	4.5	57	256.
SILIKATY	0.09	5.5	0.5	32	15.
SOAP COSMET		1.2		26	
STARKE	0.14	12.0	1.6	66	100.
ZH PRIK KH	0.24	7.8	1.9	363	682.
GENERAL CHEMISTRY *					
ABS PAP ACS		143.0		2	
ACC CHEM RE	1.18	44.5	52.5	63	3306.
ACT CHEM SC	0.99	12.6	12.5	492	6160.
ACT CHIM H	0.20	11.1	2.2	182	409.
ACT CIENT V	(23%) [0.03]	15.4	[0.5]	78	[37.]
ADV CHEM SE	0.45	22.8	10.3	205	2103.
AM SCIENT	(10%) [0.66]	14.2	[9.3]	50	[465.]
AN AC BRASI	(25%) [0.18]	9.2	[1.6]	84	[138.]
AN AS QUIM	0.04	11.3	0.5	34	17.
AN QUIMICA		0.0		0	
AN REAL SOC	0.07	12.0	0.8	147	118.
ANN CHEM	0.97	16.2	15.7	239	3748.
ANN CHIM	1.58	9.9	15.6	37	578.
ANN CHIM FR		0.0		0	
ANN CHIM PH	0.51	26.8	13.7	61	835.
ANN NY ACAD	(20%) [1.28]	15.9	[20.5]	616	[12610.]
ANN RP CH		222.2		50	
ARCH SCI	(15%) [1.37]	3.6	[4.9]	16	[78.]
ARK KEMI		0.0		0	
ARM KHIM ZH	0.09	5.0	0.4	191	86.
ATT ANL R F	(20%) [0.47]	14.0	[6.6]	56	[371.]
AUST J CHEM		0.0		0	
AUST J SCI	(10%) [0.79]	15.2	[12.1]	568	[6860.]
B AC POL SC	(30%) [0.49]	4.9	[2.4]	661	[1586.]
B CHEM S J	0.48	12.6	6.1	1013	6189.
B CSAR BELG	(15%) [0.14]	6.9	[1.0]	66	[63.]
B NJ ACAD S	(5%)	0.0		0	
B POL CHIM		0.0		0	

*See Note on p. A-15

JOURNAL ASSIGNMENTS & INFLUENCE MEASURES (1973 DATA)
31-JAN-75

		INFL WT	REFS /PUB	INFL /PUB	PUBS	TOT INFL
CHEMISTRY (CONTINUED)						
GENERAL CHEMISTRY (CONTINUED)						
B RES C ISR	(15%)	[0.36]	12.4	[4.5]	461	[2074.]
B S CHIM BE		0.57	15.0	8.5	73	623.
B S CHIM FR		0.40	19.5	7.9	708	5572.
CAN J CHEM		0.76	17.8	13.6	615	8339.
CHEM BER		1.53	17.2	26.4	436	11469.
CHEM BRIT		0.44	14.2	6.3	54	342.
CHEM COMM			0.0		0	
CHEM LETT		0.08	6.8	0.6	393	216.
CHEM LISTY		0.12	29.7	3.5	98	339.
CHEM NZ			10.8		9	
CHEM REV		0.71	209.0	148.6	27	4011.
CHEM SCR			15.1		81	
CHEM SOC RE		1.05	79.5	83.2	22	1831.
CHEM ZEITUN		0.05	24.3	1.3	114	145.
CHEM ZVESTI		0.14	10.3	1.4	110	155.
CHIMIA		0.45	11.5	5.2	111	575.
COLL CZECH		0.43	11.8	5.1	499	2535.
CR AC SCI	(50%)	[1.46]	4.9	[7.2]	3251	[23505.]
CR AC SCI C			0.0		0	
CR SOC PHYS	(10%)		2.6		5	
CROAT CHEM		0.17	15.0	2.5	67	170.
CURRENT SCI	(30%)	[0.37]	5.0	[1.9]	434	[807.]
DAN BOLG	(30%)	[0.13]	4.4	[0.6]	473	[265.]
DAN BSSR	(30%)	[0.14]	2.8	[0.4]	296	[118.]
DAN SSSR	(35%)	[1.52]	5.0	[7.5]	2307	[17395.]
DOP UKR A	(10%)	[0.03]	1.7	[0.1]	299	[18.]
ENDEAVOUR	(30%)	[0.77]	17.1	[13.2]	21	[277.]
EXPERIENTIA	(5%)	[0.60]	9.1	[5.4]	995	[5423.]
FIN KEM MED			13.7		8	
GAZ CHIM IT		0.48	13.8	6.6	122	808.
HELV CHIM A		1.10	16.8	18.4	273	5015.
I J CHEM		0.11	9.4	1.0	501	526.
IAN SSS KH			0.0		0	
IAN SSSR	(30%)	[0.67]	10.0	[6.6]	1444	[9588.]
IMPACT SCI	(5%)		3.6		18	
ISR J CHEM			0.0		0	
J AM CHEM S		2.20	24.5	53.8	1813	97612.
J CHEM EDUC		0.61	5.5	3.3	427	1426.
J CHEM S		1.41	14.4	20.4	2962	60277.
J CHEM S CH			0.0		0	
J CHIN CHEM		0.06	8.7	0.5	27	14.
J FAC TOK 1	(2%)		5.7		8	
J FRANKL I	(5%)	[1.13]	5.7	[6.5]	73	[473.]
J IND CH S		0.34	7.7	2.6	219	574.
J INDIAN I	(30%)	[0.96]	4.4	[4.2]	14	[59.]
J INTERD CY	(10%)	[0.11]	8.4	[0.9]	44	[40.]
J LABEL COM		0.07	7.1	0.5	101	50.
J RES NBS	(25%)	[2.54]	14.4	[36.5]	82	[2997.]
J RES NBS A	(50%)		0.0		0	
J RS NZ	(5%)		0.0		0	
J SA CHEM I			9.0		32	

JOURNAL ASSIGNMENTS & INFLUENCE MEASURES (1973 DATA)
31-JAN-75

		INFL WT	REFS /PUB	INFL /PUB	PUBS	TOT INFL
CHEMISTRY (CONTINUED)						
GENERAL CHEMISTRY (CONTINUED)						
KEM KOZLEM		0.01	48.7	0.3	43	13.
KEM TIDSKR		1.38	2.9	3.9	41	161.
KHIM PRIR S		0.08	5.5	0.5	319	147.
MAGY KEM FO		0.09	9.3	0.9	117	102.
MAGY KEM LA		0.02	8.3	0.2	65	10.
MAT FYS MED	(20%)		0.0		0	
MAT FYS SKR	(10%)		0.0		0	
MONATS CHEM		0.46	11.5	5.3	216	1136.
NATURE	(1%) [2.82]	11.6	[32.6]	2397	[78070.]	
NATURE-PHYS	(30%)		0.0		0	
NATURWISSEN	(15%) [1.98]	7.8	[15.4]	242	[3734.]	
NIP KAG KAI		0.44	6.2	2.7	548	1496.
NZ J SCI	(15%) [0.41]	10.7	[4.4]	76	[338.]	
P OAMB PHIL	(5%) [4.76]	4.9	[23.2]	111	[2577.]	
P JAP ACAD	(5%) [1.56]	4.7	[7.3]	179	[1305.]	
P KON NED	(10%) [0.61]	7.9	[4.9]	112	[544.]	
P KON NED B	(25%)		0.0		0	
P NAS IND	(20%)		0.0		0	
P NAS IND A	(40%)		0.0		0	
P NAS US	(5%) [3.15]	18.6	[58.6]	789	[46243.]	
P R IR AC	(10%) [0.86]	9.8	[8.4]	34	[285.]	
P R IR AC B	(20%)		0.0		0	
P ROY SOC	(24%) [8.16]	15.8	[129.0]	191	[24635.]	
P ROY SOC A	(30%)		0.0		0	
P RS EDIN	(10%) [3.23]	4.9	[15.9]	20	[317.]	
P RS EDIN A	(20%)		0.0		0	
PHI T ROY	(5%) [2.14]	13.4	[28.6]	169	[4835.]	
PHI T ROY B	(10%)		0.0		0	
REC TR CHIM		1.66	13.2	21.9	136	2973.
RECHERCHE	(10%) [0.87]	13.1	[0.9]	32	[30.]	
REV PO QUIM			17.2		17	
REV RO CHIM		0.08	11.4	0.9	229	206.
ROCNZ CHEM		0.14	10.5	1.5	308	450.
SCI AM	(10%)		0.9		95	
SCI PROGR	(10%) [0.21]	31.8	[6.7]	19	[127.]	
SCI R TOH A	(30%)		16.9		8	
SCI STUD	(10%)		1.0		8	
SCIENCE	(4%) [3.29]	13.9	[45.7]	1016	[46482.]	
SCIENTIA	(15%)		2.4		17	
SEARCH	(20%) [0.25]	5.1	[1.3]	66	[84.]	
SOC SCI LOD		0.04	8.7	0.3	57	18.
SOV SCI REV	(20%)		6.1		7	
SUOM KEMIST		0.39	12.6	4.9	76	372.
T NY AC SCI	(20%) [1.10]	18.1	[20.0]	34	[680.]	
T ROY SOC C	(20%)		2.8		12	
T RS S AFR	(5%)		8.9		10	
T WISC AC	(5%)		0.0		0	
TEXAS J SCI	(10%) [0.39]	7.3	[2.9]	22	[63.]	
UAR J CHEM			0.0		0	

JOURNAL ASSIGNMENTS & INFLUENCE MEASURES (1973 DATA)
31-JAN-75

	INFL WT	REFS /PUB	INFL /PUB	PUBS	TOT INFL
CHEMISTRY (CONTINUED)					
GENERAL CHEMISTRY (CONTINUED)					
UKR KHIM ZH	0.29	5.4	1.6	320	499.
USP KH	0.05	122.9	6.2	80	496.
V MOSK U KH		4.5		191	
VAN SSSR (35%)		0.0		0	
Z CHEM	0.33	7.7	2.6	249	640.
Z NATURFO (36%) [1.17]		12.7	[14.8]	599	[8865.]
Z NATURFO A (45%)		0.0		0	
ZH OBS KH	0.44	11.2	4.9	478	2366.
POLYMERS					
ADHES AGE		0.1		45	
EUR POLYM J	0.19	12.7	2.5	134	331.
J ADHESION	0.62	7.5	4.7	17	79.
J APPL POLY	0.29	10.3	3.0	318	944.
J MACR S CH		0.0		0	
J MACR S PH		0.0		0	
J MACR S RM		0.0		0	
J MACRO SCI	0.14	20.5	2.9	151	436.
J POL SC	0.54	12.0	6.4	897	5741.
KOBUNSH KAG	0.09	6.6	0.6	291	172.
MACROMOLEC	0.39	16.9	6.6	152	1003.
MAKROM CHEM	0.38	12.2	4.7	294	1367.
POLYM ENG S	0.18	11.7	2.2	64	138.
POLYM J	0.15	14.6	2.2	114	255.
POLYMER	0.37	12.4	4.6	127	583.
VYSO SOED	0.20	8.5	1.7	665	1137.
PHYSICAL CHEMISTRY					
ACT CRYST	2.58	11.1	28.6	796	22805.
ANN R PH CH		0.0		0	
ANN RP CH A		0.0		0	
APPL SP REV		109.0		11	
APPL SPECTR	0.97	8.5	8.2	96	786.
BER BUN GES	1.24	16.7	20.6	168	3462.
CAN J SPECT		8.7		37	
CARBON		15.8		41	
CATAL REV	0.19	85.4	15.9	8	127.
DENKI KAG		0.0		0	
ELECTR ACT	0.45	12.6	5.7	143	818.
FARADAY DIS	3.17	19.6	62.1	41	2545.
INT J QUANT	1.07	16.0	17.1	119	2033.
INT J RAD P	0.25	16.4	4.1	50	206.
J APPL CRYST	0.52	6.8	3.6	103	368.
J CATALYSIS	0.65	13.3	8.7	221	1918.
J CHEM S F1		0.0		0	
J CHEM THER	0.26	11.7	3.1	106	324.
J CHIM PHYS	0.69	15.1	10.4	223	2330.
J COLL I SC	0.36	14.6	5.3	279	1470.
J CRYST GR	0.55	12.4	6.8	151	1027.

JOURNAL ASSIGNMENTS & INFLUENCE MEASURES (1973 DATA)
31-JAN-75

	INFL WT	REFS /PUB	INFL /PUB	PUBS	TOT INFL
CHEMISTRY (CONTINUED)					
PHYSICAL CHEMISTRY (CONTINUED)					
J ELICHEM SO	0.69	11.3	7.8	395	3069.
J ELEC CHEM	0.24	13.9	3.4	391	1318.
J MOL SPECT	2.38	13.7	32.6	200	6520.
J MOL STRUC	0.35	14.5	5.2	183	944.
J PHYS CHEM	1.52	18.9	28.7	639	18358.
J QUAN SPEC	1.87	13.2	24.7	131	3233.
J SOL ST CH	0.20	14.6	2.9	176	503.
KOLL ZH	0.17	6.9	1.2	289	341.
KOLLOID-Z	0.48	13.8	6.6	134	883.
MATER RES B	0.41	8.2	3.4	188	632.
MOLEC CRYST	1.22	15.2	18.5	95	1760.
PHOTOCHEM P	(48%) [0.88]	18.6	[16.5]	134	[2209.]
RAD RES REV		0.0		0	
RADIOCH ACT	0.59	11.8	6.9	60	415.
REV PH CH J		0.0		0	
RUSS J PH R	0.54	6.1	3.3	789	2604.
SOV PH CR R	0.68	7.8	5.3	387	1630.
SPECT ACT	1.55	15.3	23.7	245	5809.
SPECT LETT	0.17	8.1	1.4	95	133.
T FARAD SOC		0.0		0	
THEOR CHIM	1.32	19.5	25.7	126	3241.
Z KRISTALL	2.28	10.5	23.9	85	2030.
Z PHYS CH F		0.0		0	
Z PHYS CH L		0.0		0	
Z PHYS CHEM	1.21	11.6	14.0	274	3847.
ZH STRUK KH	0.31	10.6	3.3	221	729.
PHYSICS					
CHEMICAL PHYSICS					
ADV MOL REL		20.6		34	
CHEM P LETT	0.39	11.1	4.3	969	4241.
J CHEM PHYS	1.36	18.2	24.8	1448	35931.
J CHEM S F2		0.0		0	
J MAGN RES	0.11	14.5	1.5	190	291.
J PHYS B		0.0		0	
MOLEC PHYS	0.35	17.8	6.2	289	1780.
SURF SCI	0.37	17.1	6.4	324	2077.
SOLID STATE PHYSICS					
J PHYS C		0.0		0	
J PHYS CH S	1.24	16.2	20.1	252	5078.
PHYS LETT A		0.0		0	
PHYS REV B		0.0		0	
PHYS ST S-B		0.0		0	
PHYS ST SOL	0.31	11.9	3.7	1496	5505.
SOL ST COMM	0.51	9.3	4.7	777	3675.
SOV PH SE R	0.14	13.9	2.0	479	944.
SOV PH SS R	0.58	8.2	4.8	905	4308.

JOURNAL ASSIGNMENTS & INFLUENCE MEASURES (1973 DATA)
31-JAN-75

	INFL WT	REFS /PUB	INFL /PUB	PUBS	TOT INFL
PHYSICS (CONTINUED)					
SOLID STATE PHYSICS (CONTINUED)					
FLUIDS & PLASMAS					
ANN R FLUID	0.26	34.1	8.8	16	140.
J FLUID MEC	1.31	10.0	13.1	236	3092.
J PLASMA PH	0.39	10.5	4.1	71	290.
NUCL FUSION	0.56	12.2	6.8	79	536.
PHYS FLUIDS	1.39	9.9	13.9	362	5014.
PLASMA PHYS	0.56	8.1	4.5	124	556.
APPLIED PHYSICS					
ACT POLY PH		0.0		0	
APPL PHYS L	1.89	7.2	13.6	498	6748.
CRYOGENICS	0.40	7.8	3.1	151	465.
ENERGY CONV	0.45	6.8	3.1	16	49.
FERROELECTR	0.20	29.1	5.7	23	131.
HIGH TEMP R	0.07	7.6	0.5	263	137.
HIGH TEMP S	0.25	15.8	3.9	42	163.
I J PA PHYS	0.06	8.5	0.5	348	181.
IEEE J Q EL	0.70	15.6	10.9	159	1730.
INFRAR PHYS	0.50	6.7	3.3	35	117.
J APPL PHYS	1.23	11.3	13.9	1051	14619.
J L TEMP PH	0.22	18.2	4.0	174	696.
J MECANIQUE	0.56	5.9	3.3	22	72.
J MECH PHYS	2.95	7.6	22.5	22	496.
J PHYS D		0.0		0	
J PHYS E		0.0		0	
J PHYS F		0.0		0	
J VAC SCI T	0.42	13.6	5.7	156	883.
JAP J A PHY	0.34	7.4	2.5	433	1074.
METROLOGIA	0.80	8.9	7.2	24	172.
NUCL INSTR	0.65	8.8	5.7	627	3593.
PHIL RES R	0.86	17.3	14.8	37	548.
PHIL TECH R	0.49	8.0	3.9	36	140.
PHYS ST S-A		0.0		0	
PRIB TEKHN	0.23	2.8	0.6	537	349.
REP NRL PRO	0.10	1.6	0.2	241	39.
REV G THERM		2.0		40	
REV IN HAUT	0.12	13.0	1.6	28	46.
REV PHYS AP	0.19	9.8	1.8	60	110.
REV SCI INS	1.72	5.5	9.5	434	4127.
SOV PH TP R	0.77	6.4	4.9	367	1809.
THIN FILMS		7.0		8	
THIN SOL FI	0.15	11.8	1.8	248	436.
VACUUM	0.22	8.7	2.0	77	152.
VAKUUM-TECH	0.02	9.9	0.2	28	7.
VIDE	0.19	4.1	0.8	43	34.
ACOUSTICS					
ACUSTICA	0.33	6.8	2.2	110	245.

JOURNAL ASSIGNMENTS & INFLUENCE MEASURES (1973 DATA)
31-JAN-75

		INFL WT	REFS /PUB	INFL /PUB	PUBS	TOT INFL
PHYSICS (CONTINUED)						
ACOUSTICS (CONTINUED)						
IEEE AUDIO		0.22	6.6	1.4	76	109.
IEEE SON UL		0.55	12.0	6.6	51	338.
J ACOUST SO		1.50	10.0	15.0	350	5250.
J AUD ENG S		0.17	5.6	0.9	71	66.
J SOUND VIB		0.27	7.4	2.0	191	382.
SOV PH AC R		0.43	7.7	3.3	108	361.
ULTRASONICS		0.29	6.4	1.8	32	58.
OPTICS						
APPL OPTICS		0.82	9.5	7.8	430	3337.
J OPT SOC		1.95	12.1	23.5	232	5464.
J PHOT SCI		0.13	13.0	1.7	43	74.
LICHTTECH			1.6		41	
OPT ENG			7.0		44	
OPTICA ACTA		0.42	10.7	4.5	63	282.
OPTIK		0.60	7.2	4.3	107	463.
PHOT SCI EN		0.13	13.3	1.7	91	159.
PHOTOGR ENG		0.49	2.1	1.0	85	88.
PHOTOGRAMMA			4.0		12	
SCI LIGHT			10.0		8	
ZH NP FOTOG		0.06	6.5	0.4	78	28.
GENERAL PHYSICS*						
ACT SCIENT V	(10%)	[0.03]	15.4	[0.5]	78	[37.]
ACT PHYS AU		0.24	12.4	3.0	54	164.
ACT PHYS CH		0.47	10.5	4.9	23	113.
ACT PHYS H		0.33	13.4	4.4	42	184.
ADV PHYSICS		1.12	125.1	140.4	11	1545.
AM J PHYS		0.94	3.0	2.9	323	924.
AM SCIENT	(10%)	[0.66]	14.2	[9.3]	50	[465.]
AN AC BRASI	(15%)	[0.18]	9.2	[1.6]	84	[138.]
AN FISICA			7.0		32	
ANN BRUX 1	(70%)		6.0		27	
ANN PHYSICS		1.66	17.4	29.0	147	4256.
ANN PHYSIK		1.95	8.8	17.2	49	842.
ANN PHYSIQ			0.0		0	
ANN R NUCL		0.45	116.8	52.7	12	632.
APPL SCI B			0.0		0	
APPL SCI RE	(50%)	[1.36]	6.6	[9.0]	52	[470.]
ARB U B MAT	(60%)		0.0		0	
ARCH SCI	(10%)	[1.37]	3.6	[4.9]	16	[78.]
ATT ANL R F	(15%)	[0.47]	14.0	[6.6]	56	[371.]
AUST J PHYS			0.0		0	
AUST J SCI	(5%)	[0.79]	15.2	[12.1]	568	[6860.]
B AC POL SC	(10%)	[0.49]	4.9	[2.4]	661	[1586.]
B OSAR BELG	(35%)	[0.14]	6.9	[1.0]	66	[63.]
B NJ ACAD S	(5%)		0.0		0	
B POL MATH	(20%)		0.0		0	
CAN J PHYS		0.86	13.3	11.5	339	3898.

*See Note on p. A-15

JOURNAL ASSIGNMENTS & INFLUENCE MEASURES (1973 DATA)
31-JAN-75

		INFL WT	REFS /PUB	INFL /PUB	PUBS	TOT INFL
PHYSICS (CONTINUED)						
GENERAL PHYSICS (CONTINUED)						
CONT PHYS		0.29	20.1	5.8	20	117.
CR AC SCI	(13%)	[1.46]	4.9	[7.2]	3251	[23505.]
CR AC SCI B	(70%)		0.0		0	
CR SOC PHYS	(10%)		2.6		5	
CURRENT SCI	(15%)	[0.37]	5.0	[1.9]	434	[807.]
CZEC J PHYS		0.22	9.3	2.0	193	392.
DAN BOLG	(20%)	[0.13]	4.4	[0.6]	473	[265.]
DAN BSSR	(20%)	[0.14]	2.8	[0.4]	296	[118.]
DAN SSSR	(20%)	[1.52]	5.0	[7.5]	2307	[17395.]
DOP UKR A	(25%)	[0.03]	1.7	[0.1]	299	[18.]
ENDAVOUR	(30%)	[0.77]	17.1	[13.2]	21	[277.]
FORTSCHR PH		0.37	32.1	11.7	16	187.
HELV PHYS A		1.15	4.4	5.1	180	918.
I J PHYSICS		0.34	7.6	2.6	74	189.
I J THEOR P			3.7		4	
IAN SSS FIZ			0.0		0	
IAN SSSR	(40%)	[0.67]	10.0	[6.6]	1444	[9588.]
IMPACT SCI	(5%)		3.6		18	
IVUZ FIZ		0.01	5.0	0.0	435	13.
J FAC TOK 1	(2%)		5.7		8	
J FRANKL I	(30%)	[1.13]	5.7	[6.5]	73	[473.]
J INDIAN I	(25%)	[0.96]	4.4	[4.2]	14	[59.]
J INTERD CY	(5%)	[0.11]	8.4	[0.9]	44	[48.]
J PHYS		0.59	13.1	7.7	1672	12908.
J PHYS A			0.0		0	
J PHYS JAP			0.0		0	
J PHYSIQUE		1.08	14.7	15.9	119	1887.
J RES NBS	(25%)	[2.54]	14.4	[36.5]	82	[2997.]
J RES NBS A	(50%)		0.0		0	
J RS NZ	(5%)		0.0		0	
JETP LETTER		1.25	9.8	12.2	349	4268.
LETT NUOV C		0.32	8.1	2.6	609	1583.
MAT FYS MED	(80%)		0.0		0	
MAT FYS SKR	(80%)		0.0		0	
NATURE	(1%)	[2.82]	11.6	[32.6]	2397	[78070.]
NATURE-PHYS	(30%)		0.0		0	
NATURWISSEN	(10%)	[1.98]	7.8	[15.4]	242	[3734.]
NUOV CIM		1.04	13.8	14.3	449	6425.
P CAMB PHIL	(40%)	[4.76]	4.9	[23.2]	111	[2577.]
P JAP ACAD	(5%)	[1.56]	4.7	[7.3]	179	[1305.]
P KON NED	(20%)	[0.61]	7.9	[4.9]	112	[544.]
P KON NED B	(50%)		0.0		0	
P NAS IND	(20%)		0.0		0	
P NAS IND A	(40%)		0.0		0	
P NAS US	(2%)	[3.15]	18.6	[58.6]	789	[46243.]
P PM S JAP		0.74	10.4	7.6	820	6257.
P R IR AC	(20%)	[0.86]	9.8	[8.4]	34	[285.]
P R IR AC A	(40%)		0.0		0	
P ROY SOC	(48%)	[8.16]	15.8	[129.0]	191	[24635.]
P ROY SOC A	(60%)		0.0		0	
P RS EDIN	(10%)	[3.23]	4.9	[15.9]	20	[317.]

JOURNAL ASSIGNMENTS & INFLUENCE MEASURES (1973 DATA)
31-JAN-75

		INFL WT	REFS /PUB	INFL /PUB	PUBS	TOT INFL
PHYSICS (CONTINUED)						
GENERAL PHYSICS (CONTINUED)						
P RS EDIN A	(20%)		0.0		0	
PHI T ROY	(5%) [2.14]	13.4		[28.6]	169	[4835.]
PHI T ROY B	(10%)		0.0		0	
PHILOS MAG		1.97	12.7	24.9	228	5673.
PHYS LETT		1.60	7.5	12.1	1622	19578.
PHYS LETT B			0.0		0	
PHYS NORVEG		0.73	12.8	9.4	12	112.
PHYS REV		1.42	18.6	26.4	3648	96307.
PHYS REV A			0.0		0	
PHYS REV L		3.42	11.1	38.1	897	34185.
PHYS SCR		0.17	15.8	2.8	149	411.
PHYS TODAY		0.41	17.2	7.0	33	232.
PHYSICA		0.85	13.0	11.1	309	3433.
PROG T PHYS		0.55	17.0	9.4	396	3711.
RECHERCHE	(25%) [0.07]	13.1		[0.9]	32	[30.]
REP PR PHYS		0.27	117.6	31.6	29	917.
REV M PHYS		2.10	116.9	245.8	18	4424.
REV RO PHYS		0.08	8.2	0.7	113	75.
SCI AM	(10%)		0.9		95	
SCI PROGR	(20%) [0.21]	31.8		[6.7]	19	[127.]
SCI R TOH A	(40%)		16.9		8	
SCI STUD	(20%)		1.0		8	
SCIENCE	(1%) [3.29]	13.9		[45.7]	1016	[46482.]
SCIENTIA	(15%)		2.4		17	
SEARCH	(5%) [0.25]	5.1		[1.3]	66	[84.]
SOV J NUC R		0.52	16.2	8.4	315	2637.
SOV PH JE R		2.35	10.6	24.9	598	14902.
SOV SCI REV	(20%)		6.1		7	
STU CER FIZ		0.00	13.5	0.0	97	1.
T NY AC SCI	(25%) [1.10]	18.1		[20.0]	34	[680.]
T ROY SOC C	(5%)		2.8		12	
T RS S AFR	(5%)		8.9		10	
T WISC AC	(5%)		0.0		0	
TEXAS J SCI	(10%) [0.39]	7.3		[2.9]	22	[63.]
VAN SSSR	(30%)		0.0		0	
Z NATURFO	(36%) [1.17]	12.7		[14.8]	599	[8865.]
Z NATURFO A	(45%)		0.0		0	
Z PHYS		1.11	14.5	16.0	346	5529.
NUCLEAR & PARTICLE PHYSICS						
NUCL PHYS		0.93	21.8	20.2	1209	24446.
NUCL PHYS A			0.0		0	
NUCL PHYS B			0.0		0	
PHYS REV C			0.0		0	
PHYS REV D			0.0		0	
USP FIZ NAU		0.20	63.9	12.6	64	806.
MISCELLANEOUS PHYSICS						
ANN I HEN A		0.99	7.6	7.6	40	303.

JOURNAL ASSIGNMENTS & INFLUENCE MEASURES (1973 DATA)
31-JAN-75

	INFL WT	REFS /PUB	INFL /PUB	PUBS	TOT INFL
PHYSICS (CONTINUED)					
MISCELLANEOUS PHYSICS (CONTINUED)					
COMM MATH P	1.41	7.5	10.5	122	1286.
J COMPUT PH	0.19	8.1	1.5	128	192.
J MATH PHYS	1.54	9.2	14.1	290	4092.
PHYS COND M	0.60	24.2	14.5	31	450.
TRANSP THEO		8.5		11	
EARTH AND SPACE SCIENCE					
ASTRONOMY & ASTROPHYSICS					
ANN R ASTRO	0.87	80.6	70.5	15	1057.
ASTRO SP SC	0.29	12.7	3.7	245	906.
ASTRON ASTR	0.63	14.3	8.9	470	4202.
ASTRONOM J	1.68	10.7	18.0	149	2676.
ASTRONOM ZH	0.69	7.8	5.4	188	1015.
ASTROPHYS J	1.54	15.4	23.7	977	23165.
ASTROPHYS L	1.97	10.9	21.4	105	2247.
B ASTR I CZ	0.40	6.3	2.5	62	156.
ICARUS	0.61	15.3	9.4	128	1198.
IRISH ASTR	0.17	11.7	2.0	12	24.
J ROY ASTRO	0.79	4.4	3.5	33	115.
M NOT R AST	1.22	14.5	17.7	215	3801.
OBSERVATORY	1.37	7.0	9.6	32	308.
PUB AST S J	0.53	21.0	11.1	30	332.
PUB AST S P	0.88	9.1	8.0	141	1124.
PUB DOM AST		0.0		0	
Q J R ASTRO	0.17	42.8	7.3	15	110.
SKY TELESC		0.2		66	
SOLAR PHYS	0.63	11.3	7.2	262	1876.
SPACE SCI R	0.28	55.9	15.6	34	531.
METEOROLOGY & ATMOSPHERIC SCIENCE					
ATMOS ENVIR	0.28	7.0	1.9	111	215.
B AM METEOR	1.03	5.6	5.7	53	304.
J ATMOS SCI	1.39	12.5	17.3	188	3260.
M WEATH REV	1.62	7.1	11.6	84	970.
METEOR MAG		7.6		8	
METEOR RUND		2.2		17	
PAP NET GEO		3.6		32	
Q J R METEO	2.03	11.3	22.9	53	1212.
REP ION SPA	0.36	8.7	3.2	31	98.
RIV METEO A		6.5		11	
Z METEOROL		2.9		25	
GEOLOGY					
AM A PETR G	0.61	12.6	7.6	154	1173.
AM J SCI	2.44	13.8	33.6	46	1546.
AM MINERAL	1.51	11.7	17.7	154	2727.
B S FR MIN	0.43	6.4	2.8	97	268.
CLAY CLAY M	0.76	9.8	7.4	39	290.

JOURNAL ASSIGNMENTS & INFLUENCE MEASURES (1973 DATA)
31-JAN-75

	INFL WT	REFS /PUB	INFL /PUB	PUBS	TOT INFL	
EARTH AND SPACE SCIENCE (CONTINUED)						
GEOLOGY (CONTINUED)						
CONTR MIN P	0.43	15.2	6.6	135	884.	
ECON GEOL	0.70	14.2	9.9	82	815.	
ENG GEOL		4.7		12		
GEOL MAG	0.62	7.6	4.7	67	316.	
GEOL S AM B	0.59	15.7	9.3	330	3056.	
INT J ROCK	0.25	4.7	1.2	45	54.	
J GEOL S IN	0.07	4.2	0.3	62	19.	
J GEOLOGY	1.55	17.7	27.5	36	990.	
J PALEONTOL	0.29	5.0	1.5	218	320.	
J PETROLOGY	1.27	25.1	31.8	21	667.	
J SED PETRO	0.55	10.0	5.5	125	689.	
LETHAIA	0.23	9.1	2.1	29	60.	
MARINE GEOL	0.68	11.8	8.0	41	328.	
MIN DEPOSIT	0.18	8.9	1.6	37	59.	
MINERAL MAG	1.01	8.2	8.2	66	543.	
NZ J GEOL	0.78	10.2	8.0	28	223.	
P GEOL AS C		0.0		0		
SEDIMENT GE	0.07	10.2	0.7	24	18.	
SEDIMENTOL	0.31	13.6	4.2	46	194.	
Z ANG GEOL	0.04	11.2	0.5	20	9.	
EARTH & PLANETARY SCIENCE *						
ACT SCIENT V	(2%) [0.03]	15.4	[0.5]	78	[37.]	
AM SCIENT	(20%) [0.66]	14.2	[9.3]	50	[465.]	
AN AC BRAS	(10%) [0.18]	9.2	[1.6]	84	[138.]	
ANN GEOPHIS		0.65	4.0	2.6	27	70.
ANN GEOPHYS		0.87	18.6	16.3	46	748.
ANN R EARTH			52.0		13	
ANTARCTIC J		0.19	3.1	0.6	148	87.
ARCH SCI	(50%) [1.37]	3.6	[4.9]	16	[78.]	
ARCTIC	(50%) [0.76]	3.4	[2.6]	38	[100.]	
ATT ANL R F	(10%) [0.47]	14.0	[6.6]	56	[371.]	
AUST J SCI	(15%) [0.79]	15.2	[12.1]	568	[6860.]	
B AC POL SC	(10%) [0.49]	4.9	[2.4]	661	[1586.]	
B CSAR BELG	(30%) [0.14]	6.9	[1.0]	66	[63.]	
B NJ ACAD S	(5%)	0.0		0		
B POL SCI T		0.0		0		
B RES C IER	(5%) [0.36]	12.4	[4.5]	461	[2074.]	
B SEIS S AM		1.02	10.3	10.6	141	1490.
CAN J EARTH		0.42	10.5	4.5	159	709.
CHEM GEOL		0.30	13.4	4.0	39	158.
CR AC SCI	(5%) [1.46]	4.9	[7.2]	3251	[23505.]	
CR AC SCI B	(30%)	0.0		0		
CR SOC PHYS	(40%)	2.6		5		
CURRENT SCI	(10%) [0.37]	5.0	[1.9]	434	[807.]	
DAN BOLG	(5%) [0.13]	4.4	[0.6]	473	[265.]	
DAN BSSR	(15%) [0.14]	2.8	[0.4]	296	[118.]	
DAN SSSR	(10%) [1.52]	5.0	[7.5]	2307	[17395.]	
DOP UKR A	(5%) [0.03]	1.7	[0.1]	299	[18.]	
EARTH PLAN		0.81	14.2	11.5	203	2398.

*See Note on p. A-15

JOURNAL ASSIGNMENTS & INFLUENCE MEASURES (1973 DATA)
31-JAN-75

		INFL WT	REFS /PUB	INFL /PUB	PUBS	TOT INFL
EARTH AND SPACE SCIENCE (CONTINUED)						
EARTH & PLANETARY SCIENCE (CONTINUED)						
EARTH SCI R		0.11	75.3	8.2	9	74.
ENDAVOUR	(15%)	[0.77]	17.1	[13.2]	21	[277.]
ENV SCI TEC		1.40	6.1	8.5	136	1157.
ENVIR LETT			5.9		53	
ENVIRONMENT		0.98	6.3	6.1	42	258.
GEN SYST	(10%)		3.2		16	
GEOCH COS A		1.06	19.9	21.1	200	4220.
GEOEXPLOR			3.8		14	
GEOKIMIYA		0.13	6.8	0.9	242	208.
GEOPHYS J R		0.82	15.2	12.5	108	1349.
GEOPHYSICS		1.85	6.4	11.9	78	926.
GEOTECHNIO		1.57	5.8	9.2	32	294.
IAN SSSR	(10%)	[0.67]	10.0	[6.6]	1444	[9588.]
IMPACT SCI	(5%)		3.6		18	
ISR J EARTH			0.0		0	
J ATM TER P		0.44	14.6	6.4	197	1253.
J FAC TOK 1	(2%)		5.7		8	
J FRANKL I	(10%)	[1.13]	5.7	[6.5]	73	[473.]
J GEOMAGN G		0.60	12.0	7.2	32	229.
J GEOPH RES		1.32	15.6	20.6	816	16818.
J INDIAN I	(5%)	[0.96]	4.4	[4.2]	14	[59.]
J INTERD CY	(20%)	[0.11]	8.4	[0.9]	44	[40.]
J RS NZ	(40%)		0.0		0	
NATURE	(17%)	[2.82]	11.6	[32.6]	2397	[78070.]
NATURE-PHYS	(40%)		0.0		0	
NATURWISSEN	(18%)	[1.98]	7.8	[15.4]	242	[3734.]
NZ J SCI	(25%)	[0.41]	10.7	[4.4]	76	[338.]
P CAMB PHIL	(3%)	[4.76]	4.9	[23.2]	111	[2577.]
P I A SCI B	(15%)	[1.90]	7.0	[13.3]	74	[982.]
P JAP ACAD	(5%)	[1.56]	4.7	[7.3]	179	[1305.]
P KON NED	(10%)	[0.61]	7.9	[4.9]	112	[544.]
P KON NED B	(25%)		0.0		0	
P NAS IND	(10%)		0.0		0	
P NAS IND A	(20%)		0.0		0	
P NAS US	(1%)	[3.15]	18.6	[58.6]	789	[46243.]
P R IR AC	(30%)	[0.86]	9.8	[8.4]	34	[285.]
P R IR AC A	(30%)		0.0		0	
P R IR AC B	(30%)		0.0		0	
P ROY SOC	(4%)	[8.16]	15.8	[129.0]	191	[24635.]
P ROY SOC A	(5%)		0.0		0	
P RS EDIN	(5%)	[3.23]	4.9	[15.9]	20	[317.]
P RS EDIN A	(10%)		0.0		0	
PAC SCI	(20%)	[1.00]	7.7	[7.7]	26	[200.]
PALAEOGEO P		0.34	10.0	3.4	28	94.
PHI T ROY	(40%)	[2.14]	13.4	[28.6]	169	[4835.]
PHI T ROY B	(80%)		0.0		0	
PLANET SPAC		0.64	14.0	8.9	230	2056.
PUR A GEOPH		0.13	6.0	0.8	233	182.
RADIOCARBON	(60%)	[1.26]	5.2	[6.6]	46	[302.]
RECHERCHE	(15%)	[0.07]	13.1	[0.9]	32	[30.]
REV GEOG FH		0.11	9.2	1.0	36	37.

JOURNAL ASSIGNMENTS & INFLUENCE MEASURES (1973 DATA)
31-JAN-75

		INFL WT	REFS /PUB	INFL /PUB	PUBS	TOT INFL
EARTH AND SPACE SCIENCE (CONTINUED)						
EARTH & PLANETARY SCIENCE (CONTINUED)						
REV GEOPHYS		0.74	50.8	37.5	25	938.
RIV ITAL GE			3.7		26	
SCI AM	(20%)		0.9		95	
SCI PROGR	(20%) [0.21]		31.8	[6.7]	19	[127.]
SCI STUD	(10%)		1.0		8	
SCIENCE	(18%) [3.29]		13.9	[45.7]	1016	[46482.]
SCIENTIA	(15%)		2.4		17	
SEARCH	(20%) [0.25]		5.1	[1.3]	66	[84.]
SOLAR ENERG		0.05	4.6	0.2	60	13.
SOV SCI REV	(20%)		6.1		7	
SPACE LIFE		0.02	20.1	0.4	48	19.
STUD GEOPH		1.44	2.9	4.1	45	186.
T NY AC SCI	(10%) [1.10]		18.1	[20.0]	34	[680.]
T ROY SOC C	(25%)		2.8		12	
T RS S AFR	(30%)		0.9		10	
T WISC AC	(5%)		0.0		0	
TECTONOPHYS		0.39	20.4	8.0	66	526.
TELLUS		1.69	8.5	14.5	69	398.
TEXAS J SCI	(25%) [0.39]		7.3	[2.9]	22	[63.]
VAN SSSR	(30%)		0.0		0	
Z NATURFO	(8%) [1.17]		12.7	[14.8]	599	[8865.]
Z NATURFO A	(10%)		0.0		0	
GEOGRAPHY						
GEOGR J		1.00	4.6	4.6	23	106.
OCEANOGRAPHY & LIMNOLOGY						
ANN I OCEAN			11.7		15	
ARCH HYDROB			0.0		0	
ARCH OCEAN			4.7		9	
B MARIN SCI		0.29	13.9	4.0	26	103.
BEITR MEER			4.9		19	
BER DW MEER			3.2		10	
CAH ORST OC			0.0		0	
CAH ORSTOM	(50%) [0.47]		11.2	[5.3]	30	[159.]
CONTR MAR S			9.6		12	
DEEP-SEA RE		1.46	11.2	16.3	92	1502.
HELG W MEER		0.09	10.0	0.9	71	65.
IAN SSS FRO			0.0		0	
INT HYD REV			2.3		9	
J CONSEIL			4.0		36	
J MARINE RE		3.87	7.7	29.7	22	654.
LIMN OCEAN		0.77	9.2	7.1	166	1177.
MAR TECH SJ			1.0		41	
OCEAN ENG			2.2		5	
OCEANOLOG R		0.04	6.3	0.3	125	32.
OCEANS			0.5		16	
SEA FRONT			0.0		10	

JOURNAL ASSIGNMENTS & INFLUENCE MEASURES (1973 DATA)
31-JAN-75

	INFL WT	REFS /PUB	INFL /PUB	PUBS	TOT INFL
EARTH AND SPACE SCIENCE (CONTINUED)					
OCEANOGRAPHY & LIMNOLOGY (CONTINUED)					
VIE MILIE (40%) [0.61]	6.8	[4.2]	63	[264.]
VIE MILIE B	0.0			0	
ENGINEERING AND TECHNOLOGY					
CHEMICAL ENGINEERING					
A I CH E J	0.89	10.5	9.4	234	2191.
AM GAS AS M		0.0		28	
CAN J CH EN	0.41	10.6	4.3	128	554.
CHEM ENG	2.68	1.3	3.6	185	659.
CHEM ENG L	0.67	6.0	4.0	113	454.
CHEM ENG N		0.0		0	
CHEM ENG FR	9.25	0.9	8.2	163	1341.
CHEM ENG SC	0.64	9.4	6.0	246	1478.
CHEM INSTR	0.46	7.6	3.5	22	77.
CHEM-ING-T	0.29	6.3	1.8	265	485.
CHIM IND GC		2.4		9	
COKE CHEM R	0.26	1.9	0.5	161	79.
ERD KOH EPB	0.87	4.4	3.8	74	281.
FUEL	0.39	8.4	3.2	54	175.
HYDROC PROC	0.91	2.1	1.9	156	301.
ING CHIM IT	0.07	8.0	0.6	25	15.
INT CHEM EN	0.10	6.4	0.7	101	67.
J CAN PET T		3.3		24	
J CHEM EN D	0.80	8.1	6.4	134	860.
J I FUEL	0.27	18.4	5.0	13	65.
J I PETROL	0.67	5.9	3.9	36	140.
J PETRO TEC	0.21	12.1	2.6	83	213.
PER POLY CE		0.0		0	
PIPE GAS J		0.2		35	
POWD TECH	0.11	7.4	0.8	66	54.
PROCESS TEC		6.6		35	
REV I F PET	0.06	7.4	0.4	36	15.
SOC PET E J	0.32	6.4	2.1	38	79.
T SOC RHEOL	0.62	12.0	7.4	46	342.
WORLD OIL	0.06	1.5	0.1	75	7.
MECHANICAL ENGINEERING					
ABRASIV ENG		0.8		4	
ACT MECHAN	0.27	6.3	1.7	61	104.
ACT POLY ME		0.0		0	
ARCH MECH	0.13	4.9	0.6	95	62.
ASHRAE J		0.7		75	
ASLE TRANS	1.18	7.1	8.4	30	252.
BALL BEAR J		0.1		28	
BRENN WARME	0.10	6.9	0.7	61	43.
COMB EXPL R		0.0		0	
COMB FLAME	0.17	10.2	1.7	110	187.
COMB SCI T	0.11	5.2	0.6	49	28.

JOURNAL ASSIGNMENTS & INFLUENCE MEASURES (1973 DATA)
31-JAN-75

	INFL WT	REFS /PUB	INFL /PUB	PUBS	TOT INFL
ENGINEERING AND TECHNOLOGY (CONTINUED)					
MECHANICAL ENGINEERING (CONTINUED)					
COMBUSTION		1.1		46	
CUT TOOL EN		0.3		7	
EXP MECH	0.29	4.8	1.4	83	116.
HYDRA PNEUM		0.1		63	
INT J FRACT	0.31	5.4	1.7	59	99.
INT J HEAT	0.24	9.0	2.2	221	488.
INT J MACH	0.43	3.6	1.6	17	27.
INT J MECH	0.52	4.8	2.5	90	226.
J APPL MECH		0.0		0	
J BASIC ENG		0.0		0	
J ENG IND		0.0		0	
J ENG POWER		0.0		0	
J FLUID ENG		6.7		64	
J HEAT TRAN		0.0		0	
J JAP S LUB		6.5		131	
J LUB TECH		0.0		0	
J MECH ENG	1.05	3.5	3.7	53	198.
LUBRIC ENG	0.55	3.9	2.1	40	85.
LUBRICATION		3.0		1	
MACH PROD E		0.4		18	
MACH TOOL R		0.0		0	
MACHINE DES		0.1		118	
MACHINERY		0.0		16	
MASCHIN TEC	0.51	1.7	0.9	79	70.
MECH ENG		1.0		51	
MECH HANDL		2.0		1	
MECH MACH T	0.80	2.0	1.6	33	53.
MECHANIK	0.38	0.6	0.2	132	30.
PER POLY ME		0.0		0	
POWER ENG		0.0		33	
PUMPS		0.2		10	
Q J MECH AP	1.70	6.2	10.6	35	370.
REFRIG AIR		0.2		31	
SAE J A ENG		0.2		35	
T ASME	0.43	5.0	2.2	655	1421.
THERM ENG R	0.55	4.9	2.7	301	807.
WEAR	0.57	5.3	3.0	142	429.
CIVIL ENGINEERING					
ACT POLY CI		0.0		0	
BYGNIN MEDD		0.0		4	
CIVIL ENG		0.1		98	
DESALINATN	0.26	9.0	2.6	38	99.
EFF WAT TRE		2.4		21	
GROUND WAT		0.0		2	
HIGHW ENG		0.0		7	
J AM WATER	1.32	2.7	3.5	123	433.
J ENVIR ENG	0.51	3.7	1.9	46	86.
J ENVIR SCI		0.9		18	

JOURNAL ASSIGNMENTS & INFLUENCE MEASURES (1973 DATA)
31-JAN-75

	INFL WT	REFS /PUB	INFL /PUB	PUBS	TOT INFL
ENGINEERING AND TECHNOLOGY (CONTINUED)					
CIVIL ENGINEERING (CONTINUED)					
J WATER P C	0.29	13.5	4.0	197	782.
P I CIV ENG	1.51	2.4	3.7	55	202.
PUBL ROADS		2.0		13	
TRAFFIC Q		0.7		32	
WATER RES	0.29	8.6	2.5	143	357.
WATER RES R	0.27	5.9	1.6	197	315.
WATER W ENG		0.6		20	
WATER WASTE		0.0		83	
ELECTRICAL ENGINEERING & ELECTRONICS					
ACT POLY EL		0.0		0	
ANN TELECOM	0.07	4.6	0.3	37	12.
ARCH ELEK U	0.15	4.7	0.7	95	66.
ARCH ELEKTR	1.04	3.0	3.1	24	75.
ARCH TECH M	0.09	5.5	0.5	48	24.
AUST J INST		0.6		8	
AUT REMOT R		0.0		0	
AUTOMATICA	0.21	10.0	2.1	61	130.
AUTOMATISME		1.6		28	
BELL LAB RE		0.0		47	
BELL SYST T	4.53	6.2	28.2	96	2707.
BROWN BOV R	0.68	2.2	1.5	63	93.
CONTR INSTR		1.1		28	
CONTROL ENG		0.7		23	
EEI B		0.0		5	
ELEC COMMUN	0.12	2.1	0.3	55	14.
ELEC EN JAP	0.07	5.4	0.4	125	50.
ELEC REV		0.5		66	
ELEC TECH R	1.07	8.4	8.9	23	206.
ELECTR CO J	0.01	4.6	0.1	259	18.
ELECTR ENG	1.29	1.5	1.9	59	114.
ELECTR LETT	0.84	3.5	2.9	393	1155.
ELECTR POW	0.24	1.4	0.3	56	19.
ELECTR PROD		0.0		26	
ELECTRONICS		0.1		219	
ELEKTR Z B	0.99	1.2	1.2	76	93.
ELETTROTECN	0.06	2.5	0.1	48	7.
ERICSSON RE		3.2		13	
ERICSSON TE		7.0		3	
IEEE AER EL		0.0		0	
IEEE ANTENN		0.0		0	
IEEE AUTO C	0.91	4.7	4.3	216	922.
IEEE B TELE		0.0		0	
IEEE BROADC		0.0		0	
IEEE C TECH		0.0		0	
IEEE CIRC T		0.0		0	
IEEE DEVICE		0.0		0	
IEEE E WRIT		0.0		0	
IEEE EDUCAT		0.0		0	

JOURNAL ASSIGNMENTS & INFLUENCE MEASURES (1973 DATA)
31-JAN-75

	INFL WT	REFS /PUB	INFL /PUB	PUBS	TOT INFL
ENGINEERING AND TECHNOLOGY (CONTINUED)					
ELECTRICAL ENGINEERING & ELECTRONICS (CONTINUED)					
IEEE EL INS		0.0		0	
IEEE ELM OS		0.0		0	
IEEE ELMAGN		0.0		0	
IEEE GEOSCI		0.0		0	
IEEE IND AP		0.0		0	
IEEE IND EL		0.0		0	
IEEE INSTR		0.0		0	
IEEE J SOLI		0.0		0	
IEEE MAGNET		0.0		0	
IEEE MANAGE		0.0		0	
IEEE MICR T		0.0		0	
IEEE PARTS		0.0		0	
IEEE POWER		0.0		0	
IEEE PROF C		0.0		0	
IEEE SPECTR		0.0		0	
IEEE T	0.56	5.6	3.2	2041	6429.
IEEE VEH T		0.0		0	
INSTR CONTR		0.9		57	
INSTR TECH		1.1		47	
INSTRUMENT		0.0		1	
INT ELEKTR	0.08	2.7	0.2	44	9.
INT J CONTR	0.24	4.9	1.2	236	281.
INT J EL EN		1.6		32	
INT J ELECT	0.18	5.0	0.9	197	175.
J RES NBS D		0.0		0	
J SMPTE	0.42	4.2	1.8	70	125.
JAP TELECOM		0.3		41	
MARCONI REV		3.0		13	
MEAS CONTR	0.04	2.4	0.1	39	4.
MEAS TECH R		0.0		0	
MES REG AUT		3.2		12	
MESSTECHNIK	0.07	6.6	0.4	51	23.
MICROEL REL	0.11	4.1	0.4	35	15.
NACHRTECH Z	0.09	5.3	0.5	112	52.
NEC RES DEV		4.2		39	
P EL COMP C		0.0		0	
P IEE LOND	0.83	6.0	5.0	236	1185.
P IEEE	0.82	15.7	13.0	301	3904.
PER POLY EE		0.0		0	
POINT P COM		1.8		12	
POST O EE J	0.17	4.9	0.8	26	21.
RADIO EL EN	0.16	6.2	1.0	76	78.
RADIO SCI	0.79	9.5	7.5	139	1044.
RADIOTEK EL		0.0		0	
RCA REVIEW	1.33	8.2	11.0	34	373.
REV EL COMM	0.13	3.7	0.5	63	30.
SIAM J CONT		0.0		0	
SOL ST ELEC	0.57	10.7	6.2	172	1058.
SOL ST TECH	0.30	2.9	0.9	67	58.

JOURNAL ASSIGNMENTS & INFLUENCE MEASURES (1973 DATA)
31-JAN-75

	INFL WT	REFS /PUB	INFL /PUB	PUBS	TOT INFL
ENGINEERING AND TECHNOLOGY (CONTINUED)					
ELECTRICAL ENGINEERING & ELECTRONICS (CONTINUED)					
TEL RAD E R		0.0		0	
TELECOMM J		1.8		21	
WEST ELEC E		1.0		26	
WIREL WORLD	1.07	2.1	2.3	45	103.
MISCELLANEOUS ENGINEERING & TECHNOLOGY					
AIRCRAF ENG		0.2		16	
AUDIO		1.9		9	
COMPRES AIR		0.0		5	
COST ENG		0.0		2	
DESIGN NEWS		0.2		36	
ENG EDUC	1.18	1.0	1.1	92	104.
IND PHOTOGR		0.0		21	
MANUF ENG M		0.1		10	
NAV ENG J		1.3		37	
INDUSTRIAL ENGINEERING					
IND ENG		0.1		67	
GENERAL ENGINEERING*					
ACT POLY SC	0.17	11.4	1.9	17	33.
ACT TECHN H	0.04	15.3	0.6	10	6.
APPL SCI A		0.0		0	
APPL SCI RE	(50%) [1.36]	6.6	[9.0]	52	[470.]
B AC POL SC	(10%) [0.49]	4.9	[2.4]	661	[1586.]
B CSAR BELG	(5%) [0.14]	6.9	[1.0]	66	[63.]
B INF SCI T		0.03	0.1	102	6.
B NJ ACAD S	(5%)	0.0		0	
B POL TECHN		0.0		0	
B RES C ISR	(10%) [0.36]	12.4	[4.5]	461	[2074.]
CR AC SCI	(2%) [1.46]	4.9	[7.2]	3251	[23505.]
CURRENT SCI	(5%) [0.37]	5.0	[1.9]	434	[807.]
DAN BOLG	(2%) [0.13]	4.4	[0.6]	473	[265.]
DAN BSSR	(10%) [0.14]	2.8	[0.4]	296	[118.]
DAN SSSR	(5%) [1.52]	5.0	[7.5]	2307	[17395.]
DOP UKR A	(35%) [0.03]	1.7	[0.1]	299	[18.]
ENG J		0.2		14	
ENGINEERING		0.9		39	
EURO SPECTR		3.5		12	
GEN SYST	(30%)	3.2		16	
I J TECHN	0.09	4.6	0.4	102	40.
IAN SSSR	(10%) [0.67]	10.0	[6.6]	1444	[9588.]
IMPACT SCI	(5%)	3.6		18	
IND FINISH		0.1		11	
IND LAB R	1.03	2.6	2.7	576	1526.
IND RES		1.4		34	
ING ARCH	1.84	4.3	7.9	32	254.
INT J ENG S	0.63	6.8	4.3	94	406.
ISR TRANS	0.22	2.3	0.5	47	24.

*See Note on p. A-15

JOURNAL ASSIGNMENTS & INFLUENCE MEASURES (1973 DATA)
31-JAN-75

		INFL WT	REFS /PUB	INFL /PUB	PUBS	TOT INFL
ENGINEERING AND TECHNOLOGY (CONTINUED)						
GENERAL ENGINEERING (CONTINUED)						
ISR J TECH			0.0		0	
J FRANKL I	(40%)	[1.13]	5.7	[6.5]	73	[473.]
J INDIAN I	(25%)	[0.96]	4.4	[4.2]	14	[59.]
J INTERD OY	(5%)	[0.11]	8.4	[0.9]	44	[40.]
J NAVIG			2.6		18	
J RES NBS	(25%)	[2.54]	14.4	[36.5]	82	[2997.]
J RES NBS C			0.0		0	
J SCI TECH			1.7		23	
MICROTECNIC			1.2		26	
NATURWISSEN	(2%)	[1.98]	7.8	[15.4]	242	[3734.]
NAV RES REV			2.9		33	
NBS MONOGR			255.7		3	
NZ J SCI	(20%)	[0.41]	10.7	[4.4]	76	[338.]
P CAMB PHIL	(2%)	[4.76]	4.9	[23.2]	111	[2577.]
P ROY SOC	(4%)	[8.16]	15.8	[129.0]	191	[24635.]
P ROY SOC A	(5%)		0.0		0	
PER POLYTEC		0.03	2.8	0.1	83	7.
RECHERCHE	(5%)	[0.07]	13.1	[0.9]	32	[30.]
RUSS EN J R			0.0		0	
SCI AM	(5%)		0.9		95	
SCI PROGR	(10%)	[0.21]	31.8	[6.7]	19	[127.]
SCI STUD	(20%)		1.0		8	
SCIENCE	(1%)	[3.29]	13.9	[45.7]	1016	[46482.]
SEARCH	(15%)	[0.25]	5.1	[1.3]	66	[84.]
SID J			0.3		6	
TECHNOL REV			1.0		43	
METALS & METALLURGY						
ACT METALL		1.51	17.2	26.0	184	4775.
ACT POLY CH			0.0		0	
ANTI-CORROS			7.9		8	
ARCH EISENH		0.48	10.9	5.3	118	623.
AUT WELD R		0.13	3.7	0.5	176	84.
CAN METAL Q		0.18	8.3	1.5	66	96.
CAN MIN MET		0.17	2.2	0.4	109	41.
CORROS SCI		0.28	11.1	3.1	87	271.
CORROS TRAI			4.2		12	
CORROSION		0.59	7.4	4.3	82	353.
FONDERIE FR		0.23	4.0	0.9	30	27.
INT J POWD			1.7		24	
J AUS I MET		1.21	5.2	6.3	11	69.
J ENG MATER			4.2		43	
J I METALS		3.64	6.9	25.1	50	1257.
J IRON ST I		1.71	8.2	14.3	86	1226.
J LESSC MET		0.60	10.4	6.3	171	1072.
J METALS		3.64	5.6	17.0	31	526.
J SA I MIN		0.02	2.4	0.0	33	1
JERNKON ANN			6.0		1	
MEM S R MET		0.33	10.9	3.6	86	306.

JOURNAL ASSIGNMENTS & INFLUENCE MEASURES (1973 DATA)
31-JAN-75

	INFL WT	REFS /PUB	INFL /PUB	PUBS	TOT INFL
ENGINEERING AND TECHNOLOGY (CONTINUED)					
METALS & METALLURGY (CONTINUED)					
METAL CONST	1.95	1.7	3.3	35	117.
METAL ENG Q	0.35	2.3	0.8	50	39.
METAL PROGR		0.3		59	
METAL STAMP		0.0		14	
METAL TREAT		0.0		3	
METALL	0.19	6.9	1.3	102	137.
METALL ITAL	0.05	4.1	0.2	99	19.
METALL MET	2.58	2.1	5.4	36	193.
METALLURG T	1.35	12.3	16.6	413	6868.
MIN CONGR J		0.5		56	
MIN MET Q		1.9		25	
OXID METAL	0.18	12.0	2.2	32	70.
PCM PCE		0.0		0	
PHYS MET R	0.22	8.2	1.8	1081	1924.
POWD METALL	0.80	5.9	4.7	26	123.
REV METALL	1.02	4.0	4.1	51	211.
RUSS MET R		0.0		0	
SCI R TOH A		16.9		8	
SCRIP METAL	0.38	7.4	2.8	253	708.
STAHL EISEN	0.75	18.1	13.6	38	515.
STEEL USSR	0.21	2.1	0.4	344	155.
SUMITOMO SE		2.5		25	
T IRON ST I	0.33	13.8	4.5	46	208.
T JAP I MET	0.38	10.7	4.1	78	319.
TEC MIT K F		3.0		15	
TEC MIT K W		1.3		15	
WELD PROD R	0.11	4.2	0.5	186	89.
WELD RES C	0.10	16.7	1.7	12	21.
WELDING J	0.59	3.0	1.8	108	193.
WIRE		4.4		9	
WT 2 IND FE		0.6		113	
Z METALLKUN	0.72	16.6	11.9	122	1449.
MATERIALS SCIENCE					
AM CERAM S	0.33	6.2	2.0	72	146.
AM DYE REP	0.34	2.6	0.9	76	67.
AM PAP IND		0.2		27	
APPITA	0.11	5.2	0.6	40	23.
B S FR CER	0.10	3.9	0.4	24	9.
CERAMICS		0.1		7	
CONCRETE		0.7		18	
CONCRETE Q		0.0		0	
ENG MAT DES		2.4		15	
EUROPLAST M		1.0		8	
GLASS TECH		0.0		0	
HOLZ ROH WE	0.16	4.1	0.7	58	39.
HOLZF HOLZV	0.02	8.7	0.2	18	3.
HOLZFORSCH	0.17	6.5	1.1	44	48.
IND DIAM FE		1.6		32	

JOURNAL ASSIGNMENTS & INFLUENCE MEASURES (1973 DATA)
31-JAN-75

	INFL WT	REFS /PUB	INFL /PUB	PUBS	TOT INFL
ENGINEERING AND TECHNOLOGY (CONTINUED)					
MATERIALS SCIENCE (CONTINUED)					
J AM CERAM	1.03	9.1	9.4	225	2110.
J COMPOS MA	1.64	4.3	7.1	33	235.
J I WOOD SC	0.04	15.3	0.6	12	7.
J MATER SCI	0.26	15.5	4.1	207	851.
J PRE CONCR		0.2		38	
J S DYE COL	0.58	10.1	5.8	47	273.
J S GLASS T	1.02	8.9	9.1	50	453.
J TEST EVAL	0.12	4.9	0.6	120	72.
J TEXTILE I	0.50	8.0	4.0	71	285.
KAUT GUM KU	0.26	5.2	1.4	44	60.
KUNSTSTOFFE		0.5		19	
MAG CONCR R		2.5		22	
MATER ENG		0.2		20	
MATER EVAL	0.47	1.5	0.7	56	39.
MATER PROT	0.25	1.7	0.4	85	37.
MATER SCI E	0.34	14.8	5.1	78	398.
MOD PLAST		0.3		43	
NON-DESTR T		2.0		24	
NORSK SKOG		0.9		13	
PAP FUU	0.06	8.2	0.5	43	21.
PAP TECHNOL		1.0		48	
PAPIER	0.13	4.3	0.6	87	50.
PHYS C GLAS		0.0		0	
PLAST POLYM	0.25	5.8	1.5	33	48.
PLAST WORLD		0.0		28	
PLASTICA		2.3		31	
POLYM-PLAST		0.0		0	
PROG MAT SC		0.0		0	
PULP PAPER		3.6		10	
REFRACTOR J		2.8		9	
RUBBER AGE		1.5		33	
SPE J	0.75	2.0	1.5	39	58.
SVENS PAP T	0.43	8.2	3.5	58	204.
T J BR CER	0.58	6.3	3.7	49	179.
TAPPI	0.47	4.2	2.0	239	466.
TEXT I IND		1.3		39	
TEXT RES J	0.63	9.7	6.2	112	689.
TEXTILVERED	0.15	3.3	0.5	81	40.
WOOD SCI TE	0.06	9.0	0.6	25	14.
ZELL PAPIER	0.03	3.0	0.1	56	6.
NUCLEAR TECHNOLOGY					
ATOM ENER A		3.0		11	
ATOM ENER R	0.05	95.2	4.6	20	92.
ATOM STROM		0.5		12	
ATOMKERNENE	0.09	5.1	0.5	137	66.
ATOMWIRTSCH	0.41	1.1	0.4	87	39.
ENERGA ATOM		1.2		53	
ENERGA NU M		10.2		23	

JOURNAL ASSIGNMENTS & INFLUENCE MEASURES (1973 DATA)
31-JAN-75

	INFL WT	REFS /PUB	INFL /PUB	PUBS	TOT INFL
ENGINEERING AND TECHNOLOGY (CONTINUED)					
NUCLEAR TECHNOLOGY (CONTINUED)					
ENERGA NUCL	0.31	3.3	1.0	53	54.
ENERGE NUCL		0.1		11	
IEEE NUCL S	0.68	3.2	2.2	488	1078.
J BR NUCL E	0.16	4.0	0.6	47	30.
J I NUCL EN	0.09	5.6	0.5	18	9.
J NUC SCI T	0.12	4.9	0.6	122	73.
J NUCL ENER	0.42	11.0	4.6	62	283.
J NUCL MAT	0.38	9.1	3.5	149	514.
KERNENERGIE	0.08	7.2	0.6	52	31.
KERNTECHNIK	0.26	3.4	0.9	62	55.
NUCL ENG DE	0.12	5.1	0.6	84	52.
NUCL ENG IN		0.3		47	
NUCL SCI EN	0.47	6.9	3.2	171	549.
NUCL TECH	0.31	5.2	1.6	100	163.
REACT TECH	0.15	39.7	6.0	3	18.
AEROSPACE TECHNOLOGY					
ADV SPA SCI		0.0		0	
AERONAUT J	1.15	2.8	3.2	47	149.
AERONAUT Q	0.85	6.6	5.6	21	118.
AIAA J	1.02	4.0	4.0	558	2249.
ASTRO AERON		1.4		56	
ASTRONAUT A	0.37	4.8	1.8	32	57.
CAN AER SPA		1.1		41	
CASI TRANS		3.1		7	
J ASTRONAUT		3.0		14	
J SPAC ROCK	0.39	2.8	1.1	191	208.
RECH AEROSP	0.46	2.9	1.4	33	45.
SPACEFLIGHT	0.11	7.9	0.9	18	16.
Z FLUGWISS	0.47	3.4	1.6	53	86.
COMPUTERS					
ACT POLY MA		0.0		0	
ANGEW INFOR	0.02	2.6	0.1	53	3.
COMM ACM	2.80	2.7	7.7	139	1068.
COMPUTER	0.24	1.8	0.4	40	17.
COMPUTER AU		0.6		71	
COMPUTER B		1.6		5	
COMPUTER HU		1.6		14	
COMPUTER J	2.51	3.1	7.8	82	641.
COMPUTER PH	0.05	8.1	0.4	128	50.
COMPUTING	0.28	3.6	1.0	75	76.
CYBERNETICA		3.2		12	
DATA PROCES		0.3		22	
DATAMATION		0.9		48	
ENG CYBER R		0.0		0	
IBM J RES	2.11	7.9	16.7	46	804.
IBM SYST J	4.62	2.9	13.4	22	296.
IEEE COMPUT	0.68	5.5	3.8	180	682.

JOURNAL ASSIGNMENTS & INFLUENCE MEASURES (1973 DATA)
31-JAN-75

	INFL WT	REFS /PUB	INFL /PUB	PUBS	TOT INFL
ENGINEERING AND TECHNOLOGY (CONTINUED)					
COMPUTERS (CONTINUED)					
IEEE INFO T	0.76	13.6	10.4	94	974.
IEEE MAN-MA	0.25	5.9	1.5	63	94.
IEEE SYST M		0.0		0	
INF CONTR	1.23	4.5	5.5	65	360.
INF SCI		4.9		44	
INF STORAGE	0.25	3.5	0.9	48	43.
J ACM	2.82	4.8	13.6	49	666.
PATT RECOG	0.22	9.4	2.0	26	53.
SID INT S D		0.0		0	
SIMULATION	0.30	2.5	0.8	65	49.
LIBRARY & INFORMATION SCIENCE					
ASLIB PROC		1.3		44	
B MED LIB A		4.2		32	
COLL RES LI	0.59	2.8	1.6	33	54.
FRONT LIBR		0.0		0	
INF SCIENT		1.7		10	
J AM S INFO	0.29	4.0	1.2	68	80.
J CHEM DOC	0.31	4.9	1.5	58	88.
J DOC	0.57	7.3	4.1	16	66.
J EDUC LIBR		1.0		27	
J LIBR AUT		2.7		20	
LIB RES TEC	0.17	3.3	0.6	35	20.
LIB TRENDS	0.15	5.2	0.8	40	32.
LIBRARY J		0.7		55	
LIBRARY Q		1.2		17	
NACHR DOKUM	0.06	2.3	0.1	32	4.
NAU T INF	0.00	33.0	0.2	13	2.
SPECIAL LIB	0.73	1.4	1.0	71	72.
UNESCO B LI		0.4		32	
OPERATIONS RESEARCH & MANAGEMENT SCIENCE					
IEEE RELIAB	0.34	3.7	1.2	49	61.
NAV RES LOG	0.32	4.4	1.4	74	105.
OPERAT R Q	0.17	2.2	0.4	51	19.
OPERAT RES	1.26	4.0	5.0	141	702.
REV FR AUTO		2.2		93	
TRANSP RES	0.09	3.1	0.3	26	8.
PSYCHOLOGY					
CLINICAL PSYCHOLOGY					
J ABN PSYCH	2.76	11.2	30.9	104	3200.
J CLIN PSYC	0.85	4.4	3.8	127	478.
J CONS CLIN	0.70	8.1	5.7	207	1170.
J COUN PSYC	0.28	5.7	1.6	116	188.
J INDIV PSY		4.0		12	
PSYCH PRAX		0.0		0	

JOURNAL ASSIGNMENTS & INFLUENCE MEASURES (1973 DATA)
31-JAN-75

	INFL WT	REFS /PUB	INFL /PUB	PUBS	TOT INFL
PSYCHOLOGY (CONTINUED)					
PERSONALITY & SOCIAL PSYCHOLOGY					
BR J SOCIAL	0.43	8.3	3.6	41	146.
J APPL PSYC	0.59	4.7	2.8	167	464.
J CONFL RES	0.95	6.0	5.7	41	235.
J EXP S PSY	1.12	11.4	12.7	37	471.
J PERS SOC	1.10	11.1	12.1	215	2612.
J PERSONAL	1.37	10.3	14.1	44	620.
J SOC PSYCH	0.31	5.8	1.8	168	304.
PERS PSYCH	0.61	6.4	3.9	37	144.
Z EXP R PSY	0.01	9.3	0.1	35	4.
DEVELOPMENTAL & CHILD PSYCHOLOGY					
CHILD DEV	0.82	7.3	6.1	140	847.
DEVELOP PSY	1.00	13.3	13.3	61	809.
HUMAN DEV	0.23	10.4	2.4	24	58.
J CHILD PSY	0.32	14.7	4.7	20	93.
J EXP C PSY	0.43	10.2	4.4	92	402.
MON S RES C	0.42	29.4	12.4	5	62.
EXPERIMENTAL PSYCHOLOGY					
ANIM LEAR B		10.0		75	
ANN ANIM PS		10.2		6	
B PSYCHON S		6.3		234	
J COM PHYSL	1.30	15.2	19.6	290	5736.
J EXP PSYCH	1.79	8.8	15.7	368	5763.
NEUROPSYCH	0.46	10.0	4.6	67	310.
PERC MOT SK	0.26	6.7	1.7	483	840.
PERC PSYCH	0.89	11.3	10.0	168	1685.
PHYSL PSYCH	0.05	9.6	0.5	73	36.
PSYCHON SCI	6.60	7.1	46.6	52	2423.
PSYCHOPHYSL	0.78	11.9	9.2	71	656.
Q J EXP PSY	0.88	12.5	10.9	42	460.
GENERAL PSYCHOLOGY *					
ACT PSYCHOL	1.25	8.2	10.1	45	457.
AM J PSYCHO	2.23	13.1	29.3	34	997.
AM PSYCHOL	1.51	6.3	9.5	125	1182.
AM SCIENT	(5%) [0.66]	14.2	[9.3]	50	[465.]
ANN PSYCHOL	0.02	30.4	0.7	26	18.
ANN R PSYCH	0.09	143.1	13.4	16	214.
AUST J PSYC	0.39	6.8	2.7	29	77.
BIBL PSYCH		12.0		2	
BR J PSYCHO	0.52	15.2	8.0	61	487.
CAN J PSYCH	0.89	10.6	9.5	47	446.
CAN PSYCHOL		8.0		27	
GEN SYST	(30%)	3.2		16	
HUMAN FACT	0.82	6.3	5.1	47	242.

*See Note on p. A-15

JOURNAL ASSIGNMENTS & INFLUENCE MEASURES (1973 DATA)
31-JAN-75

	INFL WT	REFS /PUB	INFL /PUB	PUBS	TOT INFL
PSYCHOLOGY (CONTINUED)					
GENERAL PSYCHOLOGY (CONTINUED)					
I J PSYCHOL		8.1		14	
IMPACT SCI (20%)		3.6		18	
J GEN PSYCH	0.56	9.4	5.3	53	281.
J INTERD CY (5%) [0.11]	[0.11]	8.4	[0.9]	44	[40.]
J PSYCHOL	0.55	5.6	3.1	130	398.
J VERB LEAR	2.42	10.4	25.2	77	1940.
JAP PSY RES	0.13	9.2	1.2	28	33.
PSYCHOL AFR	0.26	21.2	5.4	6	33.
PSYCHOL B	1.02	27.0	27.7	107	2966.
PSYCHOL FOR	0.23	19.0	4.3	20	86.
PSYCHOL ISS		0.0		5	
PSYCHOL REC	0.44	7.1	3.1	62	194.
PSYCHOL REP	0.39	5.4	2.1	497	1054.
PSYCHOL REV	3.37	29.5	99.5	32	3185.
PSYCHOL STU		3.4		10	
PSYCHOL TOD	3.10	6.9	21.4	10	214.
RECHERCHE (5%) [0.07]	[0.07]	13.1	[0.9]	32	[30.]
SC J PSYCHO	0.30	9.3	2.8	44	123.
SCI AM (5%)		0.9		95	
SCI STUD (20%)		1.0		8	
SCIENCE (10%) [3.29]	[3.29]	13.9	[45.7]	1016	[46482.]
SCIENTIA (15%)		2.4		17	
SOV PSYCO R		3.9		8	
T NY AC SCI (10%) [1.10]	[1.10]	18.1	[20.0]	34	[680.]
TRAV HUMAIN		4.9		21	
MISCELLANEOUS PSYCHOLOGY					
AM J MENT D	0.20	9.5	1.9	123	229.
BR J ED PSY	0.39	6.7	2.6	38	100.
BR J MATH S	0.33	6.9	2.2	21	47.
BR J MED PS	1.05	6.9	7.3	26	189.
COMM MENT H		3.1		19	
EDUC PSYC M	0.88	3.4	3.0	130	391.
GENET PSYCH	0.36	10.2	6.5	17	110.
INT J CE HY		8.4		23	
J ANAL PSYC		6.2		5	
J EDUC PSYC	0.44	7.7	3.3	109	364.
J GENET PSY	0.69	6.2	4.3	77	333.
J MATH PSYC	3.76	8.9	33.5	20	669.
J MENT DEF	0.21	11.8	2.5	34	85.
MEM COGNIT		12.0		79	
BEHAVIORAL SCIENCE					
ANIM BEHAV	0.94	13.5	12.7	114	1452.
BEHAV BIOL	0.02	19.6	0.4	129	58.
BEHAV RES M	0.47	2.8	1.3	122	162.
BEHAV RES T	0.93	9.1	8.5	81	690.
BEHAV SCI	1.27	7.6	9.6	35	336.
BEHAVIOUR	0.96	14.5	14.0	61	852.

JOURNAL ASSIGNMENTS & INFLUENCE MEASURES (1973 DATA)
31-JAN-75

	INFL WT	REFS /PUB	INFL /PUB	PUBS	TOT INFL
PSYCHOLOGY (CONTINUED)					
BEHAVIORAL SCIENCE (CONTINUED)					
CAN J BEH S	0.06	10.8	0.7	39	27.
HORMONE BEH	0.55	13.0	7.2	36	259.
J APPL BE A	0.59	8.9	5.2	53	278.
J APPL BEH	0.44	3.5	1.5	38	57.
J EX AN BEH	1.42	12.6	17.9	106	1893.
PHYSL BEHAV	0.40	14.1	5.7	438	2479.
MATHEMATICS					
PROBABILITY & STATISTICS					
AM STATISTN	0.03	2.9	0.1	54	5.
ANN I STAT	0.04	5.3	0.2	85	16.
ANN MATH ST	0.50	5.6	2.8	270	761.
ANN PROBAB		0.0		0	
ANN STATIST		0.0		0	
AUST J STAT		3.5		26	
B MATH STAT		0.0		0	
BIOMETR Z	0.00	4.0	0.0	49	0.
BIOMETRICS	0.17	5.8	1.0	87	86.
BIOMETRIKA	0.57	5.7	3.2	61	198.
CALC STAT A		3.2		9	
INT STAT R		0.0		0	
J AM STAT A	0.21	5.2	1.1	171	188.
J APPL PROB	0.14	3.8	0.5	94	49.
J ROY STAT	0.22	6.7	1.5	113	164.
PSYCHOMETRI	0.19	7.0	1.3	36	48.
TECHNOMET	0.20	6.0	1.2	83	100.
TEOR VEROYA	0.02	34.2	0.6	11	7.
THEOR PRO R		0.0		0	
Z WAHRSCH V	0.60	5.2	3.1	93	289.
APPLIED MATHEMATICS					
ACT SCI MAT	0.93	11.0	10.2	22	224.
ARCH R MECH	1.31	7.2	9.4	79	740.
B SCI MATH		3.7		6	
COM PA MATH	6.89	5.6	38.3	29	1110.
INT J COM N		4.8		12	
J ENG MATH		4.7		35	
J MATH P A		6.7		11	
J REIN MATH	1.24	5.1	6.4	98	623.
J S IA MATH	0.52	5.6	2.9	200	580.
MATH COMPUT	0.25	4.9	1.2	119	142.
MATR TENS Q		3.8		11	
NUMER MATH	0.60	4.4	2.7	60	160.
PRIKL MAT		0.0		0	
Q APPL MATH	0.74	4.8	3.5	47	167.
SIAM J A MA		0.0		0	
SIAM J NUM	0.17	6.7	1.2	86	100.
SIAM REV	0.15	19.4	2.9	30	87.

JOURNAL ASSIGNMENTS & INFLUENCE MEASURES (1973 DATA)
31-JAN-75

	INFL WT	REFS /PUB	INFL /PUB	PUBS	TOT INFL
MATHEMATICS (CONTINUED)					
APPLIED MATHEMATICS (CONTINUED)					
STUD APPL M		5.2		26	
TENSOR	0.03	3.5	0.1	184	20.
Z ANG MA ME	0.11	3.8	0.4	237	102.
Z ANG MATH	0.28	5.0	1.4	97	138.
GENERAL MATHEMATICS*					
ACT MATH	6.24	9.1	57.0	15	855.
ACT MATH H	0.22	3.4	0.8	106	82.
ADV MATH	1.30	3.7	4.8	38	184.
AM J MATH	7.99	6.2	49.5	36	1781.
AM MATH MO	0.67	2.8	1.9	166	309.
AN AC BRASI	(3%) [0.18]	9.2	[1.6]	84	[138.]
ANN BRUX 1	(30%)	6.0		27	
ANN I FOUR	1.88	5.5	10.3	46	472.
ANN MATH	9.20	9.9	90.6	40	3626.
ARE U B MAT	(40%)	0.0		0	
ARCH MATH	0.93	3.4	3.2	93	298.
ARK MATEMAT		0.0		0	
ATT ANL R F	(30%) [0.47]	14.0	[6.6]	56	[371.]
B AC POL SC	(10%) [0.49]	4.9	[2.4]	661	[1586.]
B AM MATH S	1.73	4.9	8.4	228	1915.
B OSAR BELG	(5%) [0.14]	6.9	[1.0]	66	[63.]
B POL MATH	(80%)	0.0		0	
B S MATH FR	1.62	5.2	8.3	53	442.
CAN J MATH	0.74	4.9	3.6	177	644.
CAN MATH B	0.36	3.4	1.2	74	89.
COLL MATH	0.31	5.0	1.5	69	107.
COMM MATH H	1.72	11.3	19.3	19	367.
COMP MATH	0.89	5.1	4.5	30	136.
CR AC SCI	(5%) [1.46]	4.9	[7.2]	3251	[23505.]
CR AC SCI A		0.0		0	
CZEC MATH J	0.83	3.3	2.7	41	112.
DAN BOLG	(3%) [0.13]	4.4	[0.6]	473	[265.]
DAN BSSR	(5%) [0.14]	2.8	[0.4]	296	[118.]
DAN SSSR	(5%) [1.52]	5.0	[7.5]	2307	[17395.]
DOP UKR A	(25%) [0.03]	1.7	[0.1]	299	[18.]
DUKE MATH J	1.75	4.9	8.6	87	749.
GLAS MATH J	0.56	3.7	2.0	31	63.
IAN SSSR	(3%) [0.67]	10.0	[6.6]	1444	[9588.]
ILL J MATH	1.01	5.8	5.9	62	366.
INDI MATH J	1.35	5.3	7.1	93	661.
INVENT MATH	1.30	6.3	8.2	60	494.
ISR J MATH		0.0		0	
J FAC TOK 1	(92%)	5.7		8	
J FRANKL I	(5%) [1.13]	5.7	[6.5]	73	[473.]
J INTERD CY	(5%) [0.11]	8.4	[0.9]	44	[40.]
J LOND MATH	0.90	4.1	3.7	173	644.
J MATH ANAL	0.40	5.1	2.0	261	527.
J MATH JAP		0.0		0	

*See Note on p. A-15

JOURNAL ASSIGNMENTS & INFLUENCE MEASURES (1973 DATA)
31-JAN-75

		INFL WT	REFS /PUB	INFL /PUB	PUBS	TOT INFL
MATHEMATICS (CONTINUED)						
GENERAL MATHEMATICS (CONTINUED)						
J RES NBS	(25%)	[2.54]	14.4	[36.5]	82	[2997.]
J RES NBS B			0.0		0	
MANUSC MATH		0.17	4.5	0.8	73	56.
MAT FYS SKR	(10%)		0.0		0	
MATH ANNAL		1.76	5.2	9.1	194	1762.
MATH NACHR		0.55	9.5	5.2	46	241.
MATH SCAND		1.17	5.3	6.2	61	376.
MATH Z		1.63	6.1	9.9	143	1416.
MATHEMATIKA		2.45	4.0	9.7	25	242.
MEM AM MATH			16.7		4	
MICH MATH J		1.95	5.6	10.9	31	338.
MONATS MATH		0.70	4.0	2.8	36	101.
NAG MATH J		0.98	4.3	4.2	55	233.
NOT AM MATH			483.0		1	
P AM MATH S		0.74	3.5	2.6	691	1790.
P CAMB PHIL	(50%)	[4.76]	4.9	[23.2]	111	[2577.]
P EDIN MATH		0.51	4.0	2.0	33	67.
P JAP ACAD	(60%)	[1.56]	4.7	[7.3]	179	[1305.]
P KON NED	(20%)	[0.61]	7.9	[4.9]	112	[544.]
P KON NED A			0.0		0	
P LOND MATH		1.79	7.0	12.6	72	908.
P NAS US	(1%)	[3.15]	18.6	[58.6]	789	[46243.]
P R IR AC	(15%)	[0.86]	9.8	[8.4]	34	[285.]
P R IR AC A	(30%)		0.0		0	
P RS EDIN	(25%)	[3.23]	4.9	[15.9]	20	[317.]
P RS EDIN A	(50%)		0.0		0	
PAC J MATH		0.80	5.0	4.0	336	1341.
Q J MATH		1.22	4.5	5.4	54	294.
RIC MAT			4.2		8	
SCI AM	(5%)		0.9		95	
SCIENCE	(1%)	[3.29]	13.9	[45.7]	1016	[46482.]
SCIENTIA	(10%)		2.4		17	
SCRIP MATH			4.7		34	
STUD MATH		1.79	8.2	14.7	61	899.
T AM MATH S		1.31	6.9	9.1	345	3140.
MISCELLANEOUS MATHEMATICS						
J ALGEBRA		0.89	6.0	5.3	147	784.
J ANAL MATH			4.9		13	
J DIFF EQUA		0.64	5.2	3.3	78	259.
J SYMB LOG		0.51	3.7	1.9	81	151.
Z NATH LOG		0.40	33.3	13.4	3	40.

APPENDIX II
ISI JOURNAL ABBREVIATIONS AND FULL TITLES¹

ISI ABBREVIATION	FULL TITLE	ISI ABBREVIATION	FULL TITLE
A GRAEFES A	ALBRECHT VON GRAEFES ARCHIV FUR KLINISCHE UND EXPERIMENTELLE OPHTHALMOLOGIE	ACT MATH	ACTA MATHEMATICA UPPSALA
A VAN LEEUW	ANTONIE VAN LEEUWENHOEK JOURNAL OF MICROBIOLOGY AND SEROLOGY	ACT MATH H	ACTA MATHEMATICA ACADEMIAE SCIENTIARUM HUNGARICAE
AAPG BULL	AAPG BULLETIN-AMERICAN ASSOCIATION OF PETROLEUM GEOLOGISTS	ACT MECHAN	ACTA MECHANICA
ABRASIV ENG	ABRASIVE ENGINEERING	ACT MED H	ACTA MEDICA ACADEMIAE SCIENTIARUM HUNGARICAE
ABS PAP ACS	ABSTRACTS OF PAPERS AMERICAN CHEMICAL SOCIETY	ACT MED OKA	ACTA MEDICINAE OKAYAMA
ACC CHEM RE	ACCOUNTS OF CHEMICAL RESEARCH	ACT MED SC	ACTA MEDICA SCANDINAVICA, AND SUPPLEMENTUM
ACT AGRON H	ACTA AGRONOMICA ACADEMIAE SCIENTIARUM HUNGARICAE	ACT METALL	ACTA METALLURGICA
ACT ALLERG	ACTA ALLERGologica AND SUPPLEMENTUM	ACT MIC P A	ACTA MICROBIOLOGICA POLONICA SERIES A MICROBIOLOGIA GENERALIS
ACT ANAE SC	ACTA ANAESTHESIOLOGICA SCANDINAVICA, AND SUPPLEMENTUM	ACT MIC P B	ACTA MICROBIOLOGICA POLONICA SERIES B MICROBIOLOGIA APPLICATA
ACT ANATOM	ACTA ANATOMICA, AND SUPPLEMENTUM	ACT MICRO H	ACTA MICROBIOLOGICA ACADEMIAE SCIENTIARUM HUNGARICAE
ACT BIO C B	ACTA BIOLOGICA CRACOVIENSIA, SERIES BOTANICA	ACT MORPH H	ACTA MORPHOLOGICA ACADEMIAE SCIENTIARUM HUNGARICAE, AND SUPPLEMENTUM
ACT BIO C Z	ACTA BIOLOGICA CRACOVIENSIA, SERIES ZOOLOGIA	ACT MORPH N	ACTA MORPHOLOGICA NEERLANDO-SCANDINAVICA
ACT BIO IRA	ACTA BIOCHIMICA IRANICA	ACT NEUR SC	ACTA NEUROLOGICA SCANDINAVICA, AND SUPPLEMENTUM
ACT BIO MED	ACTA BIOLOGICA ET MEDICA GERMANICA	ACT NEUROB	ACTA NEUROBIOLOGIAE EXPERIMENTALIS
ACT BIOCH H	ACTA BIOCHIMICA AND BIOPHYSICA ACADEMIAE SCIENTIARUM HUNGARICAE	ACT NEUROCH	ACTA NEUROCHIRURGICA
ACT BIOCH P	ACTA BIOCHIMICA POLONICA	ACT NEURO P	ACTA NEUROPATHOLOGICA
ACT BIOL H	ACTA BIOLOGICA ACADEMIAE SCIENTIARUM HUNGARICAE	ACT OBST SC	ACTA OBSTETRICIA ET GYNECOLOGICA SCANDINAVICA, AND SUPPLEMENTUM
ACT BOT NEE	ACTA BOTANICA NEERLANDICA	ACT ODON SC	ACTA ODDONTOLOGICA SCANDINAVICA
ACT CHEM A	ACTA CHEMICA SCANDINAVICA, SERIES A PHYSICAL AND INORGANIC CHEMISTRY	ACT OPHTH K	ACTA OPHTHALMOLOGICA, KOBENHAVN, AND SUPPLEMENTUM
ACT CHEM B	ACTA CHEMICA SCANDINAVICA, SERIES B ORGANIC CHEMISTRY AND BIOCHEMISTRY	ACT ORTH SC	ACTA ORTHOPAEDICA SCANDINAVICA, AND SUPPLEMENTUM
ACT CHIM H	ACTA CHIMICA ACADEMIAE SCIENTIARUM HUNGARICAE	ACT OTO-LAR	ACTA OTO-LARYNGOLOGICA
ACT CHIR H	ACTA CHIRURGICA ACADEMIAE SCIENTIARUM HUNGARICAE	ACT PAED H	ACTA PAEDIATRICA ACADEMIAE SCIENTIARUM HUNGARICAE
ACT CHIR SC	ACTA CHIRURGICA SCANDINAVICA	ACT PAED SC	ACTA PAEDIATRICA SCANDINAVICA, AND SUPPLEMENTUM
ACT CIENT V	ACTA CIENTIFICA VENEZOLANA	ACT PAT JAP	ACTA PATHOLOGICA JAPONICA
ACT CRYST A	ACTA CRYSTALLOGRAPHICA, SECTION A CRYSTAL PHYSICS, DIFFRACTION, THEORETICAL AND GENERAL CRYSTALLOGRAPHY	ACT PAT S A	ACTA PATHOLOGICA ET MICROBIOLOGICA SCANDINAVICA, SECTION A PATHOLOGY
ACT CRYST B	ACTA CRYSTALLOGRAPHICA, SECTION B STRUCTURAL CRYSTALLOGRAPHY AND CRYSTAL CHEMISTRY	ACT PAT S B	ACTA PATHOLOGICA ET MICROBIOLOGICA SCANDINAVICA, SECTION B MICROBIOLOGY AND IMMUNOLOGY
ACT CYTOL	ACTA CYTOLOGICA	ACT PHARM S	ACTA PHARMACEUTICA SUECICA
ACT DER-VEN	ACTA DERMATO-VENEREOLOGICA, AND SUPPLEMENTUM	ACT PHARM T	ACTA PHARMACOLOGICA ET TOXICOLOGICA, AND SUPPLEMENTUM
ACT DIABET	ACTA DIABETOLOGICA LATINA	ACT PHYS AU	ACTA PHYSICA AUSTRIACA
ACT ENDOCR	ACTA ENDOCRINOLOGICA, AND SUPPLEMENTUM	ACT PHYS CH	ACTA PHYSICA ET CHEMICA
ACT ENT BOH	ACTA ENTOMOLOGICA BOHEMOSLOVACA	ACT PHYS H	ACTA PHYSICA ACADEMIAE SCIENTIARUM HUNGARICAE
ACT GENET M	ACTA GENETICAE MEDICAE ET GEMELLOGIAE, AND SUPPLEMENTUM	ACT PHYS L H	ACTA PHYSIOLOGICA ACADEMIAE SCIENTIARUM HUNGARICAE
ACT HAEMAT	ACTA HAEMATOLOGICA	ACT PHYS L L	ACTA PHYSIOLOGICA LATINO-AMERICANA
ACT HEP-GAS	ACTA HEPATO-GASTROENTEROLOGICA	ACT PHYS L P	ACTA PHYSIOLOGICA POLONICA
ACT HIST CY	ACTA HISTOCHEMICA ET CYTOCHEMICA	ACT PHYS L S	ACTA PHYSIOLOGICA SCANDINAVICA, AND SUPPLEMENTUM
ACT HISTOCH	ACTA HISTOCHEMICA, AND SUPPLEMENTUM BAND	ACT POL PH	ACTA POLONIAE PHARMACEUTICA
		ACT POLY CH	ACTA POLYTECHNICA SCANDINAVICA CHEMISTRY INCLUDING METALLURGY SERIES
		ACT POLY CI	ACTA POLYTECHNICA SCANDINAVICA CIVIL ENGINEERING AND BUILDING CONSTRUCTION SERIES

¹ Institute for Scientific Information, Source
Publication Science Citation Index, Philadelphia,
Pa., 19106, January 1, 1975.

ISI ABBREVIATION	FULL TITLE
ACT POLY EL	ACTA POLYTECHNICA SCANDINAVICA ELECTRICAL ENGINEERING SERIES
ACT POLY MA	ACTA POLYTECHNICA SCANDINAVICA MATHEMATICS AND COMPUTING MACHINERY SERIES
ACT POLY ME	ACTA POLYTECHNICA SCANDINAVICA MECHANICAL ENGINEERING SERIES
ACT POLY PH	ACTA POLYTECHNICA SCANDINAVICA PHYSICS INCLUDING NUCLEONICS SERIES
ACT PSYC SC	ACTA PSYCHIATRICA SCANDINAVICA AND SUPPLEMENTUM
ACT PSYCHOL	ACTA PSYCHOLOGICA
ACT RAD DGN	ACTA RADIOLOGICA DIAGNOSIS
ACT RAD TPB	ACTA RADIOLOGICA THERAPY, PHYSICS, BIOLOGY
ACT SCI MAT	ACTA SCIENTIARUM MATHEMATICARUM
ACT TECHN H	ACTA TECHNICA ACADEMIAE SCIENTIARUM HUNGARICAE
ACT VET H	ACTA VETERINARIA ACADEMIAE SCIENTIARUM HUNGARICAE
ACT VET SC	ACTA VETERINARIA SCANDINAVICA AND SUPPLEMENTUM
ACT VIROLOG	ACTA VIROLOGICA ENGLISH EDITION
ACT VIT ENZ	ACTA VITAMINOLOGICA ET ENZYMOLOGICA
ACT ZOO H	ACTA ZOOLOGICA ACADEMIAE SCIENTIARUM HUNGARICAE
ACTIV NERV	ACTIVITAS NERVOSA SUPERIOR
ACUSTICA	ACUSTICA
ADHES AGE	ADHESIVES AGE
ADV CHEM SE	ADVANCES IN CHEMISTRY SERIES
ADV ENZYM	ADVANCES IN ENZYMOLOGY
ADV GENETIC	ADVANCES IN GENETICS
ADV HUM GEN	ADVANCES IN HUMAN GENETICS
ADV MAR BIO	ADVANCES IN MARINE BIOLOGY
ADV MATH	ADVANCES IN MATHEMATICS
ADV MOL REL	ADVANCES IN MOLECULAR RELAXATION PROCESSES
ADV OBSTET	ADVANCES IN OBSTETRICS AND GYNECOLOGY
ADV OPHTHAL	ADVANCES IN OPHTHALMOLOGY
ADV PHYSICS	ADVANCES IN PHYSICS
ADV PSY MED	ADVANCES IN PSYCHOSOMATIC MEDICINE
ADV R PHYSL	ADVANCES IN REPRODUCTIVE PHYSIOLOGY
ADV SPA SCI	ADVANCES IN SPACE SCIENCE AND TECHNOLOGY
AERONAUT J	AERONAUTICAL JOURNAL
AERONAUT Q	AERONAUTICAL QUARTERLY
AEROSP MED	AEROSPACE MEDICINE
AEU-ARCH EL	AEU-ARCHIV FUR ELEKTRONIK UND UBERTRAGUNGSTECHNIK/ ELECTRONICS AND COMMUNICATION
AG CHEM	AG CHEM AND COMMERCIAL FERTILIZER
AGENT ACTIO	AGENTS AND ACTIONS
AGR BIOL CH	AGRICULTURAL AND BIOLOGICAL CHEMISTRY
AGR ECON RE	AGRICULTURAL ECONOMICS RESEARCH
AGR EDUC MA	AGRICULTURAL EDUCATION MAGAZINE
AGR ENG	AGRICULTURAL ENGINEERING
AGR HOR GEN	AGRI HORTIQUE GENETICA
AGR METEOR	AGRICULTURAL METEOROLOGY
AGR RES	AGRICULTURAL RESEARCH
AGR SCI REV	AGRICULTURAL SCIENCE REVIEW
AGRESSOLOG	AGRESSOLOGIE
AGROCHIMICA	AGROCHIMICA
AGRON J	AGRONOMY JOURNAL
AIAA J	AIAA JOURNAL
AICHE J	AICHE JOURNAL
AIRCRAF ENG	AIRCRAFT ENGINEERING
AM ANTHROP	AMERICAN ANTHROPOLOGIST

ISI ABBREVIATION	FULL TITLE
AM BEHAV SC	AMERICAN BEHAVIORAL SCIENTIST
AM BIOL TEA	AMERICAN BIOLOGY TEACHER
AM CERAM S	AMERICAN CERAMIC SOCIETY BULLETIN
AM DAIRY R	AMERICAN DAIRY REVIEW
AM DYE REP	AMERICAN DYESTUFF REPORTER
AM FAM PHYS	AMERICAN FAMILY PHYSICIAN
AM GAS AS M	AMERICAN GAS ASSOCIATION MONTHLY
AM HEART J	AMERICAN HEART JOURNAL
AM IND HYG	AMERICAN INDUSTRIAL HYGIENE ASSOCIATION JOURNAL
AM J AGR EC	AMERICAN JOURNAL OF AGRICULTURAL ECONOMICS
AM J ANAT	AMERICAN JOURNAL OF ANATOMY
AM J BOTANY	AMERICAN JOURNAL OF BOTANY
AM J CARD	AMERICAN JOURNAL OF CARDIOLOGY
AM J CLIN N	AMERICAN JOURNAL OF CLINICAL NUTRITION
AM J CLIN P	AMERICAN JOURNAL OF CLINICAL PATHOLOGY
AM J DIG DI	AMERICAN JOURNAL OF DIGESTIVE DISEASES
AM J DIS CH	AMERICAN JOURNAL OF DISEASES OF CHILDREN
AM J ENOL V	AMERICAN JOURNAL OF ENOLOGY AND VITICULTURE
AM J EPIDEM	AMERICAN JOURNAL OF EPIDEMIOLOGY
AM J GASTRO	AMERICAN JOURNAL OF GASTROENTEROLOGY
AM J HOSP P	AMERICAN JOURNAL OF HOSPITAL PHARMACY
AM J HU GEN	AMERICAN JOURNAL OF HUMAN GENETICS
AM J MATH	AMERICAN JOURNAL OF MATHEMATICS
AM J MED	AMERICAN JOURNAL OF MEDICINE
AM J MED SC	AMERICAN JOURNAL OF THE MEDICAL SCIENCES
AM J MED TE	AMERICAN JOURNAL OF MEDICAL TECHNOLOGY
AM J MENT D	AMERICAN JOURNAL OF MENTAL DEFICIENCY
AM J OBST G	AMERICAN JOURNAL OF OBSTETRICS AND GYNECOLOGY
AM J OPHTH	AMERICAN JOURNAL OF OPHTHALMOLOGY
AM J OPTOM	AMERICAN JOURNAL OF OPTOMETRY AND PHYSIOLOGICAL OPTICS
AM J ORTHOD	AMERICAN JOURNAL OF ORTHODONTICS
AM J ORTHOP	AMERICAN JOURNAL OF ORTHOPSYCHIATRY
AM J P ANTH	AMERICAN JOURNAL OF PHYSICAL ANTHROPOLOGY
AM J PATH	AMERICAN JOURNAL OF PATHOLOGY
AM J PHAR E	AMERICAN JOURNAL OF PHARMACEUTICAL EDUCATION
AM J PHARM	AMERICAN JOURNAL OF PHARMACY
AM J PHYS	AMERICAN JOURNAL OF PHYSICS
AM J PHYS M	AMERICAN JOURNAL OF PHYSICAL MEDICINE
AM J PHYSL	AMERICAN JOURNAL OF PHYSIOLOGY
AM J PSYCHA	AMERICAN JOURNAL OF PSYCHOANALYSIS
AM J PSYCHI	AMERICAN JOURNAL OF PSYCHIATRY
AM J PSYCHO	AMERICAN JOURNAL OF PSYCHOLOGY
AM J PSYCHT	AMERICAN JOURNAL OF PSYCHOTHERAPY
AM J PUB HE	AMERICAN JOURNAL OF PUB. C. HEALTH AND THE NATIONS HEALTH
AM J ROENTG	AMERICAN JOURNAL OF ROENTGENOLOGY RADIUM THERAPY NUCLEAR MEDICINE
AM J SCI	AMERICAN JOURNAL OF SCIENCE
AM J SURG	AMERICAN JOURNAL OF SURGERY
AM J TROP M	AMERICAN JOURNAL OF TROPICAL MEDICINE AND HYGIENE
AM J VET RE	AMERICAN JOURNAL OF VETERINARY RESEARCH

ISI ABBREVIATION	FULL TITLE
AM MATH MO	AMERICAN MATHEMATICAL MONTHLY
AM MIDL NAT	AMERICAN MIDLAND NATURALIST
AM MINERAL	AMERICAN MINERALOGIST
AM NATURAL	AMERICAN NATURALIST
AM PAP IND	AMERICAN PAPER INDUSTRY
AM POTATO J	AMERICAN POTATO JOURNAL
AM PSYCHOL	AMERICAN PSYCHOLOGIST
AM R RESP D	AMERICAN REVIEW OF RESPIRATORY DISEASES
AM SCIENT	AMERICAN SCIENTIST
AM STATISTN	AMERICAN STATISTICIAN
AM ZOOLOG	AMERICAN ZOOLOGIST
AN AC BRASI	ANALIS DA ACADEMIA BRASILEIRA DE CIENCIAS
AN AS QUIM	ANALES DE LA ASOCIACION QUIMICA ARGENTINA
AN FISICA	ANALES DE FISICA
AN QUIMICA	ANALES DE QUIMICA
ANAESTHESIA	ANAESTHESIA
ANAESTHESIS	ANAESTHESIST
ANAL LETTER	ANALYTICAL LETTERS
ANALUSIS	ANALYSIS
ANALYST	ANALYST
ANALYT BIOC	ANALYTICAL BIOCHEMISTRY
ANALYT CHEM	ANALYTICAL CHEMISTRY
ANALYT CHIM	ANALYTICA CHIMICA ACTA
ANAT HIS EM	ANATOMIA HISTOLOGIA EMBRYOLOGIA ZENTRALBLATT FUR VETERINARMEDIZIN REIHE C
ANAT REC	ANATOMICAL RECORD
ANESTH AN R	ANESTHESIE ANALGESIE, REANIMATION
ANESTH ANAL	ANESTHESIA AND ANALGESIA CURRENT RESEARCHES
ANESTHESIOL	ANESTHESIOLOGY
ANGEW BOT	ANGEWANDTE BOTANIK
ANGEW CHEM	ANGEWANDTE CHEMIE INTERNATIONAL EDITION IN ENGLISH
ANGEW INFOR	ANGEWANDTE INFORMATIK
ANGEW MAKRO	ANGEWANDTE MAKROMOLEKULARE CHEMIE
ANGIOLOGY	ANGIOLOGY
ANGL ORTHOD	ANGLE ORTHODONTIST
ANIM BEHAV	ANIMAL BEHAVIOUR
ANIM LEAR B	ANIMAL LEARNING AND BEHAVIOR
ANIM PRODUC	ANIMAL PRODUCTION
ANN A PLANT	ANNALES DE L'AMELIORATION DES PLANTES
ANN AGRON	ANNALES AGRONOMIQUES
ANN ALLERGY	ANNALS OF ALLERGY
ANN ANIM PS	ANNUAL OF ANIMAL PSYCHOLOGY
ANN AP BIOL	ANNALS OF APPLIED BIOLOGY
ANN BIOL AN	ANNALES DE BIOLOGIE ANIMALE BIOCHIMIE BIOPHYSIQUE
ANN BIOL CL	ANNALES DE BIOLOGIE CLINIQUE
ANN BIOMED	ANNALS OF BIOMEDICAL ENGINEERING
ANN BOTANY	ANNALS OF BOTANY
ANN BRUX 1	ANNALES DE LA SOCIETE SCIENTIFIQUE DE BRUXELLES SERIE 1 SCIENCES MATHEMATIQUES ASTRONOMIQUES ET PHYSIQUES
ANN CARD AN	ANNALES DE CARDIOLOGIE ET D'ANGIOLOGIE
ANN CHEM	ANNALEN DER CHEMIE JUSTUS LIEBIG
ANN CHIM	ANNALI DI CHIMICA
ANN CHIM FR	ANNALES DE CHIMIE FRANCAISE
ANN CHIR	ANNALES DE CHIRURGIE
ANN CHIR GY	ANNALES CHIRURGIAE ET GYNAECOLOGIAE FENIAE

ISI ABBREVIATION	FULL TITLE
ANN CHIR IN	ANNALES DE CHIRURGIE INFANTILE
ANN CHIR PL	ANNALES DE CHIRURGIE PLASTIQUE
ANN CLIN R	ANNALS OF CLINICAL RESEARCH
ANN DER SYP	ANNALES DE DERMATOLOGIE ET DE SYPHILIGRAPHIE
ANN ENDOCR	ANNALES D'ENDOCRINOLOGIE ET SUPPLEMENTAIRE
ANN ENT S A	ANNALS OF THE ENTOMOLOGICAL SOCIETY OF AMERICA
ANN GASTRO	ANNALES DE GASTROENTEROLOGIE ET D'HEPATOLOGIE
ANN GENET	ANNALES DE GENETIQUE
ANN GEOFIS	ANNALI DI GEOFISICA
ANN GEOPHYS	ANNALES DE GEOPHYSIQUE
ANN HISTOCH	ANNALES D'HISTOCHIMIE
ANN HUM BIO	ANNALS OF HUMAN BIOLOGY
ANN HUM GEN	ANNALS OF HUMAN GENETICS
ANN HYDROB	ANNALES D'HYDROBIOLOGIE
ANN I FOUR	ANNALES DE L'INSTITUT FOURIER
ANN I HEN A	ANNALES DE L'INSTITUT HENRI POINCARÉ SECTION A PHYSIQUE THEORIQUE
ANN I HEN B	ANNALES DE L'INSTITUT HENRI POINCARÉ SECTION B CALCUL DES PROBABILITÉS ET STATISTIQUE
ANN I OCEAN	ANNALES DE L'INSTITUT OCEANOGRAPHIQUE
ANN I STAT	ANNALS OF THE INSTITUTE OF STATISTICAL MATHEMATICS
ANN IMMUNOL	ANNALES D'IMMUNOLOGIE
ANN INT MED	ANNALS OF INTERNAL MEDICINE
ANN MATH	ANNALS OF MATHEMATICS
ANN MICROB	ANNALES DE MICROBIOLOGIE
ANN MO BOT	ANNALS OF THE MISSOURI BOTANICAL GARDEN
ANN NUC SCI	ANNALS OF NUCLEAR SCIENCE AND ENGINEERING
ANN NUTR AL	ANNALES DE LA NUTRITION ET DE L'ALIMENTATION
ANN NY ACAD	ANNALS OF THE NEW YORK ACADEMY OF SCIENCES
ANN OTOL RH	ANNALS OF OTOTOLOGY RHINOLOGY AND LARYNGOLOGY
ANN PHARM F	ANNALES PHARMACEUTIQUES FRANCAISES
ANN PHYS BI	ANNALES DE PHYSIQUE BIOLOGIQUE ET MEDICALE
ANN PHYSICS	ANNALS OF PHYSICS
ANN PHYSIK	ANNALEN DER PHYSIK
ANN PHYSIQ	ANNALES DE PHYSIQUE
ANN PROBAB	ANNALS OF PROBABILITY
ANN PSYCHOL	ANNEE PSYCHOLOGIQUE
ANN R ASTRO	ANNUAL REVIEW OF ASTRONOMY AND ASTROPHYSICS
ANN R BIOC	ANNUAL REVIEW OF BIOCHEMISTRY
ANN R BIOPH	ANNUAL REVIEW OF BIOPHYSICS AND BIOENGINEERING
ANN R EARTH	ANNUAL REVIEW OF EARTH AND PLANETARY SCIENCE
ANN R ENTOM	ANNUAL REVIEW OF ENTOMOLOGY
ANN R FLUID	ANNUAL REVIEW OF FLUID MECHANICS
ANN R GENET	ANNUAL REVIEW OF GENETICS
ANN R MED	ANNUAL REVIEW OF MEDICINE
ANN R MICRO	ANNUAL REVIEW OF MICROBIOLOGY
ANN R NUCL	ANNUAL REVIEW OF NUCLEAR SCIENCE
ANN R PH CH	ANNUAL REVIEW OF PHYSICAL CHEMISTRY
ANN R PHARM	ANNUAL REVIEW OF PHARMACOLOGY
ANN R PHYSL	ANNUAL REVIEW OF PHYSIOLOGY
ANN R PHYTO	ANNUAL REVIEW OF PHYTOPATHOLOGY
ANN R PLANT	ANNUAL REVIEW OF PLANT PHYSIOLOGY

ISI ABBREVIATION	FULL TITLE
ANN R PSYCH	ANNUAL REVIEW OF PSYCHOLOGY
ANN RADIOL	ANNALES DE RADIOLOGIE RADIOLOGIE CLINIQUE - RADIOBIOLOGIE
ANN RHEUM D	ANNALS OF THE RHEUMATIC DISEASES
ANN RP CH A	ANNUAL REPORTS ON THE PROGRESS OF CHEMISTRY SECTION A GENERAL PHYSICAL AND INORGANIC CHEMISTRY
ANN RP CH B	ANNUAL REPORTS ON THE PROGRESS OF CHEMISTRY SECTION B ORGANIC CHEMISTRY
ANN SCLAVO	ANNALI SCLAVO
ANN SOC ENT	ANNALES DE LA SOCIETE ENTOMOLOGIQUE DE FRANCE
ANN STATIST	ANNALS OF STATISTICS
ANN SURG	ANNALS OF SURGERY
ANN TEC AGR	ANNALES DE TECHNOLOGIE AGRICOLE
ANN TELECOM	ANNALES DES TELECOMMUNICATIONS
ANN TROP M	ANNALS OF TROPICAL MEDICINE AND PARASITOLOGY
ANN UROL	ANNALES D UROLOGIE
ANN ZOOTECH	ANNALES DE ZOOTECHNIE
ANTARCTIC J	ANTARCTIC JOURNAL OF THE UNITED STATES
ANTI-CORROS	ANTI-CORROSION METHODS AND MATERIALS
ANTIBIOTIKI	ANTIBIOTIKI
ANTIM AG CH	ANTIMICROBIAL AGENTS AND CHEMOTHERAPY
APPITA	APPITA
APPL MICROB	APPLIED MICROBIOLOGY
APPL OPTICS	APPLIED OPTICS
APPL PHYS	APPLIED PHYSICS
APPL PHYS L	APPLIED PHYSICS LETTERS
APPL SCI RE	APPLIED SCIENTIFIC RESEARCH
APPL SP REV	APPLIED SPECTROSCOPY REVIEWS
APPL SPECTR	APPLIED SPECTROSCOPY
AQUACULTURE	AQUACULTURE
ARB U B MAT	ARBEID FOR UNIVERSITETET I BERGEN MATEMATISK-NATURVITENSKAPELIG SERIE
ARCH ANAT M	ARCHIVES D ANATOMIE MICROSCOPIQUE ET DE MORPHOLOGIE EXPERIMENTALE
ARCH BIOCH	ARCHIVES OF BIOCHEMISTRY AND BIOPHYSICS
ARCH BIOL M	ARCHIVOS DE BIOLOGIA Y MEDICINA EXPERIMENTALES
ARCH DERM F	ARCHIV FUR DERMATOLOGISCHE FORSCHUNG
ARCH DERMAT	ARCHIVES OF DERMATOLOGY
ARCH DIS CH	ARCHIVES OF DISEASE IN CHILDHOOD
ARCH EISENH	ARCHIV FUR DAS EISENHUTTENWESEN
ARCH ELEK U	ARCHIV FUR ELEKTRONIK UND UBERTRAGUNGSTECHNIK
ARCH ELEKTR	ARCHIV FUR ELEKTROTECHNIK
ARCH ENV HE	ARCHIVES OF ENVIRONMENTAL HEALTH
ARCH FISCH	ARCHIV FUR FISCHEREIWISSENSCHAFT
ARCH FR MAL	ARCHIVES FRANCAISES DES MALADIES DE L APPAREIL DIGESTIF
ARCH FR PED	ARCHIVES FRANCAISES DE PEDIATRIE
ARCH G PSYC	ARCHIVES OF GENERAL PSYCHIATRY
ARCH G VIR	ARCHIV FUR DIE GESAMTE VIRUSFORSCHUNG
ARCH GESCHW	ARCHIV FUR GESCHWULSTFORSCHUNG
ARCH GYNAC	ARCHIV FUR GYNKOLOGIE
ARCH HIST E	ARCHIVE FOR HISTORY OF EXACT SCIENCES
ARCH HYDROB	ARCHIV FUR HYDROBIOLOGIE
ARCH I BIOL	ARCHIVOS DE INSTITUTO DE BIOLOGIA ANDINA
ARCH I PHAR	ARCHIVES INTERNATIONALES DE PHARMACODYNAMIE ET DE THERAPIE
ARCH I PHYS	ARCHIVES INTERNATIONALES DE PHYSIOLOGIE ET DE BIOCHIMIE

ISI ABBREVIATION	FULL TITLE
ARCH IN MED	ARCHIVES OF INTERNAL MEDICINE
ARCH INV M	ARCHIVOS DE INVESTIGACION MEDICA
ARCH IT BIO	ARCHIVES ITALIENNES DE BIOLOGIE
ARCH MAL C	ARCHIVES DES MALADIES DU COEUR ET DES VAISSEAUX
ARCH MAL PR	ARCHIVES DES MALADIES PROFESSIONNELLES DE MEDECINE DU TRAVAIL ET DE SECURITE SOCIALE
ARCH MATH	ARCHIV DER MATHEMATIK
ARCH MECH	ARCHIVES OF MECHANICS
ARCH MICROB	ARCHIVES OF MICROBIOLOGY
ARCH NEUROL	ARCHIVES OF NEUROLOGY
ARCH OCEAN	ARCHIVO DI OCEANOGRAFIA E LIMNOLOGIA
ARCH OPHTAL	ARCHIVES D OPHTALMOLOGIE
ARCH OPHTH	ARCHIVES OF OPHTHALMOLOGY
ARCH ORAL B	ARCHIVES OF ORAL BIOLOGY
ARCH ORTHOP	ARCHIV FUR ORTHOPADISCHE UND UNFALLCHIRURGIE
ARCH OTO-R	ARCHIVES OF OTORHINO-LARYNGOLOGY
ARCH OTOLAR	ARCHIVES OF OTOLARYNGOLOGY
ARCH PATH	ARCHIVES OF PATHOLOGY
ARCH PHARM	ARCHIV DER PHARMAZIE UND BERICHTE DER DEUTSCHEN PHARMAZEUTISCHEN GESELLSCHAFT
ARCH PHYS M	ARCHIVES OF PHYSICAL MEDICINE AND REHABILITATION
ARCH PSYCHI	ARCHIV FUR PSYCHIATRIE UND NERVENKRANKHEITEN
ARCH R MECH	ARCHIVE FOR RATIONAL MECHANICS AND ANALYSIS
ARCH S A OF	ARCHIVOS DE LA SOCIEDAD AMERICANA DE OFTALMOLOGIA Y OPTOMETRIA
ARCH SCI	ARCHIVES DES SCIENCES
ARCH SCI PH	ARCHIVES DES SCIENCES PHYSIOLOGIQUES
ARCH SURG	ARCHIVES OF SURGERY
ARCH TDXIC	ARCHIVES OF TOXICOLOGY-ARCHIV FUR TOXIKOLOGIE
ARCTIC	ARCTIC
ARDEA-T NED	ARDEA
ARK KEMI	ARKIV FOR KEMI
ARK MATEMAT	ARKIV FOR MATEMATIK
ARM KHIM ZH	ARMYANSKII KHIMICHESKII ZHURNAL
ARTH RHEUM	ARTHRITIS AND RHEUMATISM
ARZNEI-FOR	ARZNEIMITTEL-FORSCHUNG
ASHRAE J	ASHRAE JOURNAL
ASLE TRANS	ASLE TRANSACTIONS
ASLIB PROC	ASLIB PROCEEDINGS
ASTRO AERON	ASTRONAUTICS AND AERONAUTICS
ASTRO SP SC	ASTROPHYSICS AND SPACE SCIENCE
ASTRON ASTR	ASTRONOMY AND ASTROPHYSICS
ASTRONAUT A	ASTRONAUTICA ACTA
ASTRONOM J	ASTRONOMICAL JOURNAL
ASTRONOM ZH	ASTRONOMICHESKIIA ZHURNAL
ASTROPH J S	ASTROPHYSICAL JOURNAL SUPPLEMENT SERIES
ASTROPHYS J	ASTROPHYSICAL JOURNAL
ASTROPHYS L	ASTROPHYSICAL LETTERS
ATHEROSCLER	ATHEROSCLEROSIS
ATM MESS PR	ATM MESSTECHNISCHE PRAXIS
ATMOS ENVIR	ATMOSPHERIC ENVIRONMENT
ATOM ENER A	ATOMIC ENERGY AUSTRALIA
ATOM ENER R	ATOMIC ENERGY REVIEW

ISI ABBREVIATION	FULL TITLE
ATOM STROM	ATOM UND STROM
ATOMKERNENE	ATOMKERNENERGIE
ATOMNAYA EN	ATOMNAYA ENERGIYA
ATOMWIRTSCH	ATOMWIRTSCHAFT
ATT ANL R F	ATTI DELLA ACCADEMIA NAZIONALE DEI LINCEI: RENDICONTI CLASSE DI SCIENZE FISICHE MATEMATICHE E NATURALI
ATT ASS GEN	ATTI ASSOCIAZIONE GENETICA ITALIANA
AUDIO	AUDIO
AUDIOLOGY	AUDIOLOGY
AUK	AUK
AUST J AGR	AUSTRALIAN JOURNAL OF AGRICULTURAL RESEARCH
AUST J BIOL	AUSTRALIAN JOURNAL OF BIOLOGICAL SCIENCES
AUST J BOT	AUSTRALIAN JOURNAL OF BOTANY
AUST J CHEM	AUSTRALIAN JOURNAL OF CHEMISTRY
AUST J DAIR	AUSTRALIAN JOURNAL OF DAIRY TECHNOLOGY
AUST J EX B	AUSTRALIAN JOURNAL OF EXPERIMENTAL BIOLOGY AND MEDICAL SCIENCE
AUST J INST	AUSTRALIAN JOURNAL OF INSTRUMENTATION AND CONTROL
AUST J MAR	AUSTRALIAN JOURNAL OF MARINE AND FRESHWATER RESEARCH
AUST J PHYS	AUSTRALIAN JOURNAL OF PHYSICS
AUST J PSYC	AUSTRALIAN JOURNAL OF PSYCHOLOGY
AUST J SOIL	AUSTRALIAN JOURNAL OF SOIL RESEARCH
AUST J STAT	AUSTRALIAN JOURNAL OF STATISTICS
AUST J ZOO	AUSTRALIAN JOURNAL OF ZOOLOGY
AUST NZ J M	AUSTRALIAN AND NEW ZEALAND JOURNAL OF MEDICINE
AUST NZ J O	AUSTRALIAN AND NEW ZEALAND JOURNAL OF OBSTETRICS AND GYNAECOLOGY
AUST NZ J S	AUSTRALIAN AND NEW ZEALAND JOURNAL OF SURGERY
AUST PAEDIA	AUSTRALIAN PAEDIATRIC JOURNAL
AUST RADIOD	AUSTRALASIAN RADIOLOGY
AUST VET J	AUSTRALIAN VETERINARY JOURNAL
AUT ENG	AUTOMOTIVE ENGINEERING
AUT REMOT R	AUTOMATION AND REMOTE CONTROL USSR
AUT WELD R	AUTOMATIC WELDING USSR
AUTOMATICA	AUTOMATICA
AUTOMATISME	AUTOMATISME
AVIAN DIS	AVIAN DISEASES
B AM MATH S	BULLETIN OF THE AMERICAN MATHEMATICAL SOCIETY
B AM METEOR	BULLETIN OF THE AMERICAN METEOROLOGICAL SOCIETY
B AM PHYS S	BULLETIN OF THE AMERICAN PHYSICAL SOCIETY
B ASTR I CZ	BULLETIN OF THE ASTRONOMICAL INSTITUTES OF CZECHOSLOVAKIA
B CANCER	BULLETIN DU CANCER
B CHEM S J	BULLETIN OF THE CHEMICAL SOCIETY OF JAPAN
B CSAR BELG	BULLETIN DE LA CLASSE DES SCIENCES ACADEMIE ROYALE DE BELGIQUE
B EKSP BIOL	BULLETEN EKSPERIMENTALNOI BIOLOGII I MEDITSINY
B ENT RES	BULLETIN OF ENTOMOLOGICAL RESEARCH
B ENVIR CON	BULLETIN OF ENVIRONMENTAL CONTAMINATION AND TOXICOLOGY
B EUR S HUM	BULLETIN OF THE EUROPEAN SOCIETY OF HUMAN GENETICS
B I PASTEUR	BULLETIN DE L'INSTITUT PASTEUR
B I ZOO AS	BULLETIN OF THE INSTITUTE OF ZOOLOGY ACADEMIA SINICA

ISI ABBREVIATION	FULL TITLE
B INF SCI T	BULLETIN D'INFORMATIONS SCIENTIFIQUES ET TECHNIQUES AND SUPPLEMENT
B IST SIER	BOLLETTINO DELL'ISTITUTO SIROTERAPICO MILANESE
B ITAL BIOL	BOLLETTINO DELLA SOCIETA ITALIANA DI BIOLOGIA SPERIMENTALE
B JAP S S F	BULLETIN OF THE JAPANESE SOCIETY OF SCIENTIFIC FISHERIES
B JSME	BULLETIN OF THE JSME JAPAN SOCIETY OF MECHANICAL ENGINEERS
B MARIN SCI	BULLETIN OF MARINE SCIENCE
B MATH BIOL	BULLETIN OF MATHEMATICAL BIOLOGY
B MATH STAT	BULLETIN OF MATHEMATICAL STATISTICS
B MED LIB A	BULLETIN OF THE MEDICAL LIBRARY ASSOCIATION
B NARCOTICS	BULLETIN ON NARCOTICS
B NJ ACAD S	BULLETIN NEW JERSEY ACADEMY OF SCIENCE
B NY AC MED	BULLETIN OF THE NEW YORK ACADEMY OF MEDICINE
B OF SAN PA	BOLETTIN DE LA OFICINA SANITARIA PANAMERICANA
B PHYSIO PA	BULLETTIN DE PHYSIO-PATHOLOGIE RESPIRATOIRE
B POL BIOL	BULLETIN DE L'ACADEMIE POLONAISE DES SCIENCES SERIE DES SCIENCES BIOLOGIQUES
B POL CHIM	BULLETIN DE L'ACADEMIE POLONAISE DES SCIENCES SERIE DES SCIENCES CHIMIQUES
B POL MATH	BULLETIN DE L'ACADEMIE POLONAISE DES SCIENCES SERIE DES SCIENCES MATHÉMATIQUES ASTRONOMIQUES ET PHYSIQUES
B POL SCI T	BULLETIN DE L'ACADEMIE POLONAISE DES SCIENCES SERIE DES SCIENCES DE LA TERRE
B POL TECHN	BULLETIN DE L'ACADEMIE POLONAISE DES SCIENCES SERIE DES SCIENCES TECHNIQUES
B PSYCHOM S	BULLETIN OF THE PSYCHONOMIC SOCIETY
B S BOT FR	BULLETIN DE LA SOCIETE BOTANIQUE DE FRANCE
B S CH FR 1	BULLETIN DE LA SOCIETE CHIMIQUE DE FRANCE PART 1 CHIMIE ANALYTIQUE CHIMIE MINERALE CHIMIE PHYSIQUE
B S CH FR 2	BULLETIN DE LA SOCIETE CHIMIQUE DE FRANCE PART 2 CHIMIE ORGANIQUE BIOCHIMIE
B S CHIM BE	BULLETIN DES SOCIETES CHIMIQUES BELGES
B S FR CER	BULLETIN DE LA SOCIETE FRANCAISE DE CERAMIQUE
B S FR D SY	BULLETIN DE LA SOCIETE FRANCAISE DE DERMATOLOGIE ET DE SYPHILIGRAPHIE
B S FR MIN	BULLETIN DE LA SOCIETE FRANCAISE DE MINERALOGIE ET DE CRISTALLOGRAPHIE
B S MATH FR	BULLETIN DE LA SOCIETE MATHEMATIQUE DE FRANCE
B S SCI MED	BULLETIN DE LA SOCIETE DES SCIENCES MEDICALES DU GRAND-DUCHÉ DE LUXEMBOURG
B S ZOO FR	BULLETIN DE LA SOCIETE ZOOLOGIQUE DE FRANCE
B SC AK MED	BULLETIN DER SCHWEIZERISCHEN AKADEMIE DER MEDIZINISCHEN WISSENSCHAFTEN
B SCI MATH	BULLETIN DES SCIENCES MATHÉMATIQUES
B SEIS S AM	BULLETIN OF THE SEISMOLOGICAL SOCIETY OF AMERICA
B TOR BOT C	BULLETIN OF THE TORREY BOTANICAL CLUB
B WHO	BULLETIN OF THE WORLD HEALTH ORGANIZATION
BACT REV	BACTERIOLOGICAL REVIEWS
BALL BEAR J	BALL BEARING JOURNAL
BAS R CARD	BASIC RESEARCH IN CARDIOLOGY
BEHAV BIOL	BEHAVIORAL BIOLOGY

ISI ABBREVIATION	FULL TITLE
BEHAV RES M	BEHAVIOR RESEARCH METHODS AND INSTRUMENTATION
BEHAV RES T	BEHAVIOUR RESEARCH AND THERAPY
BEHAV SCI	BEHAVIORAL SCIENCE
BEHAVIOUR	BEHAVIOUR
BEITR MEER	BEITRAGE ZUR MEERESKUNDE
BEITR PATH	BEITRAGE ZUR PATHOLOGIE
BELL LAB RE	BELL LABORATORIES RECORD
BELL SYST T	BELL SYSTEM TECHNICAL JOURNAL
BER BUN GES	BERICHTE DER BUNSEN GESELLSCHAFT FÜR PHYSIKALISCHE CHEMIE
BER DEU BOT	BERICHTE DER DEUTSCHEN BOTANISCHEN GESELLSCHAFT
BER DW MEER	BERICHTE DER DEUTSCHEN WISSENSCHAFTLICHEN KOMMISSION FÜR MEERESFORSCHUNG
BERUFS-DERM	BERUFS-DERMATOSEN
BIBL ANATOM	BIBLIOTHECA ANATOMICA
BIBL CARDIO	BIBLIOTHECA CARDIOLOGICA
BIBL GASTRO	BIBLIOTHECA GASTROENTEROLOGICA
BIBL HAEM	BIBLIOTHECA HAEMATOLOGICA
BIBL MICROB	BIBLIOTHECA MICROBIOLOGICA
BIBL NUTR D	BIBLIOTHECA NUTRITIO ET DIETA
BIBL PHONET	BIBLIOTHECA PHONETICA
BIBL PRIMAT	BIBLIOTHECA PRIMATOLOGICA
BIBL PSYCH	BIBLIOTHECA PSYCHIATRICA
BIBL RADIOD	BIBLIOTHECA RADIOLOGICA
BIBL TUB ME	BIBLIOTHECA TUBERCULOSEA AND MEDICINAE THORACALIS
BIKEN J	BIKEN JOURNAL
BIO-MED ENG	BIO-MEDICAL ENGINEERING
BIOC BIOP A	BIOCHIMICA ET BIOPHYSICA ACTA
BIOC BIOP R	BIOCHEMICAL AND BIOPHYSICAL RESEARCH COMMUNICATIONS
BIOC PHY PF	BIOCHEMIE UND PHYSIOLOGIE DER PFLANZEN
BIOCH PHARM	BIOCHEMICAL PHARMACOLOGY
BIOCH SOC T	BIOCHEMICAL SOCIETY TRANSACTIONS
BIOCHEM	BIOCHEMISTRY
BIOCHEM GEN	BIOCHEMICAL GENETICS
BIOCHEM J	BIOCHEMICAL JOURNAL
BIOCHEM MED	BIOCHEMICAL MEDICINE
BIOCHIMIE	BIOCHIMIE
BIOFIZIKA	BIOFIZIKA
BIONORG CH	BIOINORGANIC CHEMISTRY
BIOKHIMIYA	BIOKHIMIYA
BIOL B	BIOLOGICAL BULLETIN
BIOL GASTRO	BIOLOGIE ET GASTRO-ENTEROLOGIE
BIOL J LINN	BIOLOGICAL JOURNAL OF THE LINNEAN SOCIETY
BIOL NEONAT	BIOLOGY OF THE NEONATE
BIOL PLANT	BIOLOGIA PLANTARUM
BIOL PSYCHI	BIOLOGICAL PSYCHIATRY
BIOL REPROD	BIOLOGY OF REPRODUCTION
BIOL REV	BIOLOGICAL REVIEWS OF THE CAMBRIDGE PHILOSOPHICAL SOCIETY
BIOL ZBL	BIOLOGISCHES ZENTRALBLATT
BIOMED EXPR	BIOMEDICINE EXPRESS
BIOMED MASS	BIOMEDICAL MASS SPECTROMETRY
BIOMEDICINE	BIOMEDICINE
BIOMETR Z	BIOMETRISCHE ZEITSCHRIFT
BIOMETRICS	BIOMETRICS
BIOMETRIKA	BIOMETRIKA
BIOORG CHEM	BIOORGANIC CHEMISTRY
BIOPHYS CH	BIOPHYSICAL CHEMISTRY
BIOPHYS J	BIOPHYSICAL JOURNAL

ISI ABBREVIATION	FULL TITLE
BIOPHYS STR	BIOPHYSICS OF STRUCTURE AND MECHANISM
BIOPOLYMERS	BIOPOLYMERS
BIOSCIENCE	BIOSCIENCE
BIO SYSTEMS	BIO SYSTEMS
BIOTECH BIO	BIOTECHNOLOGY AND BIOENGINEERING
BIOTELEMETRY	BIOTELEMETRY
BIRD BAND	BIRD-BANDING
BIRD STUDY	BIRD STUDY
BLOOD	BLOOD THE JOURNAL OF HEMATOLOGY
BLOOD VESS	BLOOD VESSELS
BLUT	BLUT
BOTAN B A S	BOTANICAL BULLETIN OF ACADEMIA SINICA
BOTAN GAZ	BOTANICAL GAZETTE
BOTAN J LIN	BOTANICAL JOURNAL OF THE LINNEAN SOCIETY
BOTAN MAG	BOTANICAL MAGAZINE TOKYO
BOTAN MARIN	BOTANICA MARINA
BOTAN NOTIS	BOTANISKA NOTISER
BOTAN REV	BOTANICAL REVIEW
BOTAN TIDS	BOTANISK TIDSSKRIFT
BR DENT J	BRITISH DENTAL JOURNAL
BR HEART J	BRITISH HEART JOURNAL
BR J ADDICT	BRITISH JOURNAL OF ADDICTION
BR J ANAEST	BRITISH JOURNAL OF ANAESTHESIA
BR J CANC	BRITISH JOURNAL OF CANCER
BR J CL PH	BRITISH JOURNAL OF CLINICAL PHARMACOLOGY
BR J DERM	BRITISH JOURNAL OF DERMATOLOGY
BR J ED PSY	BRITISH JOURNAL OF EDUCATIONAL PSYCHOLOGY
BR J EX PAT	BRITISH JOURNAL OF EXPERIMENTAL PATHOLOGY
BR J HAEM	BRITISH JOURNAL OF HAEMATOLOGY
BR J IND ME	BRITISH JOURNAL OF INDUSTRIAL MEDICINE
BR J MATH S	BRITISH JOURNAL OF MATHEMATICAL AND STATISTICAL PSYCHOLOGY
BR J MED PS	BRITISH JOURNAL OF MEDICAL PSYCHOLOGY
BR J NUTR	BRITISH JOURNAL OF NUTRITION
BR J OPHTH	BRITISH JOURNAL OF OPHTHALMOLOGY
BR J PHARM	BRITISH JOURNAL OF PHARMACOLOGY
BR J PHYS D	BRITISH JOURNAL OF PHYSIOLOGICAL OPTICS
BR J PREV S	BRITISH JOURNAL OF PREVENTIVE AND SOCIAL MEDICINE
BR J PSYCHI	BRITISH JOURNAL OF PSYCHIATRY
BR J PSYCHO	BRITISH JOURNAL OF PSYCHOLOGY
BR J RADIOD	BRITISH JOURNAL OF RADIOLOGY
BR J SOC CL	BRITISH JOURNAL OF SOCIAL AND CLINICAL PSYCHOLOGY
BR J SURG	BRITISH JOURNAL OF SURGERY
BR J VEN DI	BRITISH JOURNAL OF VENEREAL DISEASES
BR MED B	BRITISH MEDICAL BULLETIN
BR MED J	BRITISH MEDICAL JOURNAL
BR POULT SC	BRITISH POULTRY SCIENCE
BR VET J	BRITISH VETERINARY JOURNAL
BRAIN	BRAIN
BRAIN BEHAV	BRAIN, BEHAVIOR AND EVOLUTION
BRAIN LANG	BRAIN AND LANGUAGE
BRAIN RES	BRAIN RESEARCH
BRENN WARM	BRENNSTOFF-WARME-KRAFT
BRITTONIA	BRITTONIA
BROOK S BIO	BROOKHAVEN SYMPOSIA IN BIOLOGY
BROWN BOV R	BROWN BOVERI REVIEW

ISI ABBREVIATION	FULL TITLE
BYGNIN MEDD	BYGNINGSSTATISTISKE MEDDELELSER
CAH BIO MAR	CAHIERS DE BIOLOGIE MARINE
CAH ORST HY	CAHIERS ORSTOM HYDROBIOLOGIE
CAH ORST OC	CAHIERS ORSTOM OCEANOGRAPHIE
CALC STAT A	CALCUTTA STATISTICAL ASSOCIATION BULLETIN
CALCIF TISS	CALCIFIED TISSUE RESEARCH
CALIF AGR	CALIFORNIA AGRICULTURE
CALIF FISH	CALIFORNIA FISH AND GAME
CAN AER SPA	CANADIAN AERONAUTICS AND SPACE JOURNAL
CAN ANAE SJ	CANADIAN ANAESTHETISTS SOCIETY JOURNAL
CAN ENTOMOL	CANADIAN ENTOMOLOGIST
CAN FARM EC	CANADIAN FARM ECONOMICS
CAN I FOOD	CANADIAN INSTITUTE OF FOOD SCIENCE AND TECHNOLOGY JOURNAL
CAN J ANIM	CANADIAN JOURNAL OF ANIMAL SCIENCE
CAN J BEH S	CANADIAN JOURNAL OF BEHAVIOURAL SCIENCE
CAN J BIOCH	CANADIAN JOURNAL OF BIOCHEMISTRY
CAN J BOTAN	CANADIAN JOURNAL OF BOTANY
CAN J CH EN	CANADIAN JOURNAL OF CHEMICAL ENGINEERING
CAN J CHEM	CANADIAN JOURNAL OF CHEMISTRY
CAN J COM M	CANADIAN JOURNAL OF COMPARATIVE MEDICINE
CAN J EARTH	CANADIAN JOURNAL OF EARTH SCIENCES
CAN J GENET	CANADIAN JOURNAL OF GENETICS AND CYTOLOGY
CAN J MATH	CANADIAN JOURNAL OF MATHEMATICS
CAN J MED T	CANADIAN JOURNAL OF MEDICAL TECHNOLOGY
CAN J MICRO	CANADIAN JOURNAL OF MICROBIOLOGY
CAN J OPTH	CANADIAN JOURNAL OF OPHTHALMOLOGY
CAN J PH SC	CANADIAN JOURNAL OF PHARMACEUTICAL SCIENCES
CAN J PHYS	CANADIAN JOURNAL OF PHYSICS
CAN J PHYSL	CANADIAN JOURNAL OF PHYSIOLOGY AND PHARMACOLOGY
CAN J PLANT	CANADIAN JOURNAL OF PLANT SCIENCE
CAN J PSYCH	CANADIAN JOURNAL OF PSYCHOLOGY
CAN J SOIL	CANADIAN JOURNAL OF SOIL SCIENCE
CAN J SPECT	CANADIAN JOURNAL OF SPECTROSCOPY
CAN J SURG	CANADIAN JOURNAL OF SURGERY
CAN J ZOOL	CANADIAN JOURNAL OF ZOOLOGY
CAN MATH B	CANADIAN MATHEMATICAL BULLETIN
CAN MED A J	CANADIAN MEDICAL ASSOCIATION JOURNAL
CAN METAL Q	CANADIAN METALLURGICAL QUARTERLY
CAN MIN MET	CANADIAN MINING AND METALLURGICAL BULLETIN
CAN PSYCHOL	CANADIAN PSYCHOLOGIST "PSYCHOLOGIE CANADIENNE"
CAN R SOC A	CANADIAN REVIEW OF SOCIOLOGY AND ANTHROPOLOGY
CAN VET J	CANADIAN VETERINARY JOURNAL
CANC CH P1	CANCER CHEMOTHERAPY REPORTS PART 1
CANC CH P2	CANCER CHEMOTHERAPY REPORTS PART 2
CANC CH P3	CANCER CHEMOTHERAPY REPORTS PART 3
CANCER	CANCER
CANCER RES	CANCER RESEARCH
CARBOHY RES	CARBOHYDRATE RESEARCH
CARBON	CARBON
CARDIO RES	CARDIOVASCULAR RESEARCH
CARDIOLOGY	CARDIOLOGY
CARIES RES	CARIES RESEARCH

ISI ABBREVIATION	FULL TITLE
CARYOLOGIA	CARYOLOGIA
CASI TRANS	CASI TRANSACTIONS
CATAL REV	CATALYSIS REVIEWS
CELL	CELL
CELL DIFFER	CELL DIFFERENTIATION
CELL IMMUN	CELLULAR IMMUNOLOGY
CELL TIS RE	CELL AND TISSUE RESEARCH
CELL TISS K	CELL AND TISSUE KINETICS
CERAMICS	CERAMICS
CEREAL CHEM	CEREAL CHEMISTRY
CEREAL SCI	CEREAL SCIENCE TODAY
CESK C FYS	CESKOSLOVENSKY CASOPIS PRO FYSIKU SECTION A
CHEM BER	CHEMISCHE BERICHTE
CHEM BRIT	CHEMISTRY IN BRITAIN
CHEM ENG	CHEMICAL ENGINEERING
CHEM ENG L	CHEMICAL ENGINEER
CHEM ENG PR	CHEMICAL ENGINEERING PROGRESS
CHEM ENG SC	CHEMICAL ENGINEERING SCIENCE
CHEM GEOL	CHEMICAL GEOLOGY
CHEM IND L	CHEMISTRY AND INDUSTRY, LONDON
CHEM INSTR	CHEMICAL INSTRUMENTATION
CHEM LETT	CHEMISTRY LETTERS
CHEM LISTY	CHEMICKE LISTY
CHEM NZ	CHEMISTRY IN NEW ZEALAND
CHEM P LETT	CHEMICAL PHYSICS LETTERS
CHEM PHARM	CHEMICAL AND PHARMACEUTICAL BULLETIN
CHEM PHYS	CHEMICAL PHYSICS
CHEM PHYS L	CHEMISTRY AND PHYSICS OF LIPIDS
CHEM REV	CHEMICAL REVIEWS
CHEM SCR	CHEMICA SCRIPTA
CHEM SENSES	CHEMICAL SENSES AND FLAVOR
CHEM SOC RE	CHEMICAL SOCIETY REVIEWS
CHEM TECH	CHEMISCHE TECHNIK
CHEM ZEITUN	CHEMIKER ZEITUNG
CHEM ZVESTI	CHEMICKE ZVESTI
CHEM-BIO IN	CHEMICO-BIOLOGICAL INTERACTIONS
CHEM-ING-T	CHEMIE INGENIEUR-TECHNIK
CHEMOTHERA	CHEMOTHERAPY
CHEMTECH US	CHEMICAL TECHNOLOGY
CHEST	CHEST
CHILD DEV	CHILD DEVELOPMENT
CHIM IND M	CHIMICA E L INDUSTRIA MILAN
CHIMIA	CHIMIA
CHIR PLAST	CHIRURGIA PLASTICA
CHIRURG	CHIRURG
CHROMOSOMA	CHROMOSOMA
CIRC SHOCK	CIRCULATORY SHOCK
CIRCUL RES	CIRCULATION RESEARCH
CIRCULATION	CIRCULATION
CIVIL ENG	CIVIL ENGINEERING
CLAY CLAY M	CLAYS AND CLAY MINERALS
CLIN BIOCH	CLINICAL BIOCHEMISTRY
CLIN CHEM	CLINICAL CHEMISTRY
CLIN CHIM A	CLINICA CHIMICA ACTA
CLIN ENDOCR	CLINICAL ENDOCRINOLOGY
CLIN EXP IM	CLINICAL AND EXPERIMENTAL IMMUNOLOGY
CLIN EXP PH	CLINICAL AND EXPERIMENTAL PHARMACOLOGY AND PHYSIOLOGY
CLIN GENET	CLINICAL GENETICS
CLIN IMMUN	CLINICAL IMMUNOLOGY AND IMMUNOPATHOLOGY

ISI ABBREVIATION	FULL TITLE
CLIN MED	CLINICAL MEDICINE
CLIN ORTHOP	CLINICAL ORTHOPAEDICS AND RELATED RESEARCH
CLIN PEDIAT	CLINICAL PEDIATRICS
CLIN PHARM	CLINICAL PHARMACOLOGY AND THERAPEUTICS
CLIN SC MOL	CLINICAL SCIENCE AND MOLECULAR MEDICINE
CLIN TOXIC	CLINICAL TOXICOLOGY
COEUR MED I	COEUR ET MEDECINE INTERNE
COKE CHEM R	COKE AND CHEMISTRY, USSR
COLD S HARB	COLD SPRING HARBOR SYMPOSIA ON QUANTITATIVE BIOLOGY
COLL CZECH	COLLECTION OF CZECHOSLOVAK CHEMICAL COMMUNICATIONS
COLL MATH	COLLOQUIUM MATHEMATICUM
COLL RES LI	COLLEGE AND RESEARCH LIBRARIES
COLLOID P S	COLLOID AND POLYMER SCIENCE
COM FOR REV	COMMONWEALTH FORESTRY REVIEW
COM PA MATH	COMMUNICATIONS ON PURE AND APPLIED MATHEMATICS
COMB EXPL R	COMBUSTION, EXPLOSION, AND SHOCK WAVES
COMB FLAME	COMBUSTION AND FLAME
COMB SCI T	COMBUSTION SCIENCE AND TECHNOLOGY
COMBUSTION	COMBUSTION
COMM ACM	COMMUNICATIONS OF THE ACM
COMM BROADCAST	COMMUNICATION AND BROADCASTING
COMM MATH H	COMMENTARIJ MATHEMATICI HELVETICI
COMM MATH P	COMMUNICATIONS IN MATHEMATICAL PHYSICS
COMM MENT H	COMMUNITY MENTAL HEALTH JOURNAL
COMM PHYS-M	COMMENTATIONES PHYSICO-MATHEMATICAE
COMM SOIL S	COMMUNICATIONS IN SOIL SCIENCE AND PLANT ANALYSIS
COMP BIOCH	COMPARATIVE BIOCHEMISTRY AND PHYSIOLOGY
COMP GEN PH	COMPARATIVE AND GENERAL PHARMACOLOGY
COMP MATH	COMPOSITIO MATHEMATICA
COMP PSYCHI	COMPREHENSIVE PSYCHIATRY
COMPRES AIR	COMPRESSED AIR
COMPUT BIOM	COMPUTERS AND BIOMEDICAL RESEARCH
COMPUTER	COMPUTER
COMPUTER HU	COMPUTERS AND THE HUMANITIES
COMPUTER J	COMPUTER JOURNAL
COMPUTER PE	COMPUTERS AND PEOPLE
COMPUTER PH	COMPUTER PHYSICS COMMUNICATIONS
COMPUTING	COMPUTING
CONCRETE	CONCRETE
CONCRETE Q	CONCRETE QUARTERLY
CONDOR	CONDOR
CONF NEUROL	CONFINIA NEUROLOGICA
CONF PSYCH	CONFINIA PSYCHIATRICA
CONNECT TIS	CONNECTIVE TISSUE RESEARCH
CONT PHYS	CONTEMPORARY PHYSICS
CONTR INSTR	CONTROL AND INSTRUMENTATION
CONTR MAR S	CONTRIBUTIONS IN MARINE SCIENCE
CONTR MIN P	CONTRIBUTIONS TO MINERALOGY AND PETROLOGY
CONTRACEPT	CONTRACEPTION
CONTROL ENG	CONTROL ENGINEERING
COORD CH RE	COORDINATION CHEMISTRY REVIEWS
COPEIA	COPEIA
CORNELL VET	CORNELL VETERINARIAN
CORROS SCI	CORROSION SCIENCE
CORROSION	CORROSION

ISI ABBREVIATION	FULL TITLE
CR AC SCI A	COMPTES RENDUS HEBDOMADAIRES DES SEANCES DE L'ACADEMIE DES SCIENCES. SERIE A SCIENCES MATHÉMATIQUES
CR AC SCI B	COMPTES RENDUS HEBDOMADAIRES DES SEANCES DE L'ACADEMIE DES SCIENCES. SERIE B SCIENCES PHYSIQUES
CR AC SCI C	COMPTES RENDUS HEBDOMADAIRES DES SEANCES DE L'ACADEMIE DES SCIENCES. SERIE C SCIENCES CHIMIQUES
CR AC SCI D	COMPTES RENDUS HEBDOMADAIRES DES SEANCES DE L'ACADEMIE DES SCIENCES. SERIE D SCIENCES NATURELLES
CR SOC BIOL	COMPTES RENDUS DES SEANCES DE LA SOCIETE DE BIOLOGIE ET DE SES FILIALES
CR SOC PHYS	COMPTE RENDU DES SEANCES DE LA SOCIETE DE PHYSIQUE ET D'HISTOIRE NATURELLE DE GENEVE
CR TR LAB C	COMPTES RENDUS DES TRAVAUX DU LABORATOIRE CARLSBERG
CROAT CHEM	CROATICA CHEMICA ACTA
CROP SCI	CROP SCIENCE
CROPS SOILS	CROPS AND SOILS MAGAZINE
CRYBIOLOGY	CRYOBIOLOGY
CRYST LATT	CRYSTAL LATTICE DEFECTS
CURR ANTHR	CURRENT ANTHROPOLOGY
CURR CONTEN	CURRENT CONTENTS
CURR THER R	CURRENT THERAPEUTIC RESEARCH. CLINICAL AND EXPERIMENTAL
CURRENT SCI	CURRENT SCIENCE
CUT TOOL EN	CUTTING TOOL ENGINEERING
CYBERNETICA	CYBERNETICA
CYTOBIOLOG	CYTOBIOLOGIE
CYTOBIOS	CYTOBIOS
CYTOG C GEN	CYTOGENETICS AND CELL GENETICS
CYTOLOGIA	CYTOLOGIA
CZEC J PHYS	CZECHOSLOVAK JOURNAL OF PHYSICS SECTION B
CZEC MATH J	CZECHOSLOVAK MATHEMATICAL JOURNAL
DAIRY IND	DAIRY INDUSTRIES
DAN BOLG	DOKLADY BOLGARSKOI AKADEMII NAUK
DAN BSSR	DOKLADY AKADEMII NAUK BSSR
DAN MED B	DANISH MEDICAL BULLETIN
DAN SSSR	DOKLADY AKADEMII NAUK SSSR
DANSK BOTAN	DANSK BOTANISK ARKIV
DATA PROCES	DATA PROCESSING
DATAMATION	DATAMATION
DEEP-SEA RE	DEEP-SEA RESEARCH
DEMOGRAPHY	DEMOGRAPHY
DENKI KAGAKU	DENKI KAGAKU
DENT CLIN N	DENTAL CLINICS OF NORTH AMERICA
DERMATOLOG	DERMATOLOGICA
DESALINATN	DESALINATION
DESIGN NEWS	DESIGN NEWS
DEUT MED WO	DEUTSCHE MEDIZINISCHE WOCHENSCHRIFT
DEVELOP BIO	DEVELOPMENTAL BIOLOGY
DEVELOP GR	DEVELOPMENT GROWTH AND DIFFERENTIATION
DEVELOP MED	DEVELOPMENTAL MEDICINE AND CHILD NEUROLOGY
DEVELOP PSY	DEVELOPMENTAL PSYCHOBIOLOGY
DIABETES	DIABETES
DIABETOLOG	DIABETOLOGIA
DIFFERENTIA	DIFFERENTIATION
DIGESTION	DIGESTION
DIS COL REC	DISEASES OF THE COLON AND RECTUM
DIS MER SYS	DISEASES OF THE NERVOUS SYSTEM AND SUPPLEMENT
DOC OPHTHAL	DOCUMENTA OPHTHALMOLOGICA

ISI ABBREVIATION	FULL TITLE
DOP UKR A	DOPOVIDI AKADEMII NAUK UKRAINSKOI RSR
DRUG COSMET	DRUG AND COSMETIC INDUSTRY
DRUG INTEL	DRUG INTELLIGENCE AND CLINICAL PHARMACY
DRUG META D	DRUG METABOLISM AND DISPOSITION
DRUG METAB	DRUG METABOLISM REVIEWS
DRUGS	DRUGS
DUKE MATH J	DUKE MATHEMATICAL JOURNAL
EARTH PLAN	EARTH AND PLANETARY SCIENCE LETTERS
EARTH SCI R	EARTH SCIENCES REVIEWS
ECOL MONOGR	ECOLOGICAL MONOGRAPHS
ECOLOGY	ECOLOGY
ECON BOTAN	ECONOMIC BOTANY
ECON GEOL	ECONOMIC GEOLOGY AND THE BULLETIN OF THE SOCIETY OF ECONOMIC GEOLOGISTS
ECONOMETRIC	ECONOMETRICA
EDUC PSYC M	EDUCATIONAL AND PSYCHOLOGICAL MEASUREMENT
EEG CL NEUR	ELECTROENCEPHALOGRAPHY AND CLINICAL NEUROPHYSIOLOGY
EEL B	EE BULLETIN
EFF WAT TRE	EFFLUENT AND WATER TREATMENT JOURNAL
ELEC COMMUN	ELECTRICAL COMMUNICATION
ELEC EN JAP	ELECTRICAL ENGINEERING IN JAPAN
ELEC REV	ELECTRICAL REVIEW
ELEC TECH R	ELECTRIC TECHNOLOGY, USSR
ELECTR ACT	ELECTROCHIMICA ACTA
ELECTR CO J	ELECTRONICS AND COMMUNICATIONS IN JAPAN
ELECTR ENG	ELECTRONIC ENGINEERING
ELECTR LETT	ELECTRONICS LETTERS
ELECTR POW	ELECTRONICS AND POWER
ELECTR PROD	ELECTRONIC PRODUCTS MAGAZINE
ELECTRONICS	ELECTRONICS
ELEKTR Z B	ELEKTROTECHNISCHE ZEITSCHRIFT AUSGABE B
ELETTROTECN	ELETTROTECNICA
ENDEAVOUR	ENDEAVOUR
ENDOCR EXP	ENDOCRINOLOGIA EXPERIMENTALIS
ENDOCR JAP	ENDOCRINOLOGIA JAPONICA
ENDOCR RES	ENDOCRINE RESEARCH COMMUNICATIONS
ENDOCRINOL	ENDOCRINOLOGY
ENDOKRINOL	ENDOKRINOLOGIE
ENDOSCOPY	ENDOSCOPY
ENERGA ATOM	ENERGIA ES ATOMTECHNIKA
ENERGA NU M	ENERGIA NUCLEAR, MADRID
ENERGA NUCL	ENERGIA NUCLEAR
ENERGY CONV	ENERGY CONVERSION
ENG CYBER R	ENGINEERING CYBERNETICS, USSR
ENG EDUC	ENGINEERING EDUCATION
ENG GEOL	ENGINEERING GEOLOGY
ENG J	ENGINEERING JOURNAL, NEW YORK
ENG MAT DES	ENGINEERING MATERIALS AND DESIGN
ENGINEERING	ENGINEERING
ENT EXP APP	ENTOMOLOGIA EXPERIMENTALIS ET APPLICATA
ENV ENTOMOL	ENVIRONMENTAL ENTOMOLOGY
ENV PHYS BI	ENVIRONMENTAL PHYSIOLOGY AND BIOCHEMISTRY
ENV SCI TEC	ENVIRONMENTAL SCIENCE AND TECHNOLOGY
ENVIR LETT	ENVIRONMENTAL LETTERS
ENVIR POLLU	ENVIRONMENTAL POLLUTION
ENVIR RES	ENVIRONMENTAL RESEARCH
ENVIRONMENT	ENVIRONMENT

ISI ABBREVIATION	FULL TITLE
ENZYME	ENZYME
EPILEPSIA	EPILEPSIA AND SUPPLEMENT
ERD KOH EPB	ERDOL UND KOHLE ERDGAS PETROCHEMIE VEREINIGT MIT BRENNSTOFFCHEMIE
ERGER PHYSI	ERGEBNISSE DER PHYSIOLOGIE BIOLOGISCHEN CHEMIE UND EXPERIMENTELLEN PHARMAKOLOGIE
ERGONOMICS	ERGONOMICS
ERICSSON RE	ERICSSON REVIEW
ERICSSON TE	ERICSSON TECHNICS
EUPHYTICA	EUPHYTICA
EUR J A PHY	EUROPEAN JOURNAL OF APPLIED PHYSIOLOGY AND OCCUPATIONAL PHYSIOLOGY
EUR J BIOCH	EUROPEAN JOURNAL OF BIOCHEMISTRY
EUR J CANC	EUROPEAN JOURNAL OF CANCER
EUR J CL IN	EUROPEAN JOURNAL OF CLINICAL INVESTIGATION
EUR J CL PH	EUROPEAN JOURNAL OF CLINICAL PHARMACOLOGY
EUR J IMMUN	EUROPEAN JOURNAL OF IMMUNOLOGY
EUR J MED C	EUROPEAN JOURNAL OF MEDICINAL CHEMISTRY
EUR J PHARM	EUROPEAN JOURNAL OF PHARMACOLOGY
EUR NEUROL	EUROPEAN NEUROLOGY
EUR POLYM J	EUROPEAN POLYMER JOURNAL
EUR SURG RE	EUROPEAN SURGICAL RESEARCH
EURO SPECTR	EURO SPECTRA
EUROPLAST M	EUROPLASTICS MONTHLY
EVOLUTION	EVOLUTION
EXP AGRICUL	EXPERIMENTAL AGRICULTURE
EXP BRAIN R	EXPERIMENTAL BRAIN RESEARCH
EXP CELL RE	EXPERIMENTAL CELL RESEARCH
EXP EYE RES	EXPERIMENTAL EYE RESEARCH
EXP GERONT	EXPERIMENTAL GERONTOLOGY
EXP HEMATOL	EXPERIMENTAL HEMATOLOGY
EXP MECH	EXPERIMENTAL MECHANICS
EXP MOL PAT	EXPERIMENTAL AND MOLECULAR PATHOLOGY
EXP NEUROL	EXPERIMENTAL NEUROLOGY
EXP PARASIT	EXPERIMENTAL PARASITOLOGY
EXP PATH	EXPERIMENTELLE PATHOLOGIE
EXPERIENTIA	EXPERIENTIA
EYE EAR NOS	EYE EAR, NOSE AND THROAT MONTHLY
F NEUR PSYC	FORTSCHRITTE DER NEUROLOGIE UND PSYCHIATRIE UND IHRER GRENZGEBIETE
F ROENT NUK	FORTSCHRITTE AUF DEM GEBIETE DER RONTGENSTRAHLEN UND DER NUKLEARMEDIZIN
FAO PLANT	FAO PLANT PROTECTION BULLETIN
FARADAY DIS	FARADAY DISCUSSIONS OF THE CHEMICAL SOCIETY
FARMACO PRA	FARMACO EDIZIONE PRATICA
FARMACO SCI	FARMACO EDIZIONE SCIENTIFICA
FARMAKOL T	FARMAKOLOGIYA I TOKSIKOLOGIYA
FDA CONSUM	FDA CONSUMER
FEBS LETTER	FEBS LETTERS
FED PROC	FEDERATION PROCEEDINGS
FEEDSTUFFS	FEEDSTUFFS
FERROELECTR	FERROELECTRICS
FERT STERIL	FERTILITY AND STERILITY
FET SEI ANS	FETTE, SEIFEN, ANSTRICHMITTEL VERBUNDEN MIT DER ZEITSCHRIFT DIE ERNAHRUNGSINDUSTRIE
FINN CHEM L	FINNISH CHEMICAL LETTERS
FISH B	FISHERY BULLETIN OF THE NATIONAL OCEANIC AND ATMOSPHERIC ADMINISTRATION
FIZ METAL M	FIZIKA METALLOV I METALLOVEDENIE

ISI ABBREVIATION	FULL TITLE
FIZ TVERD T	FIZIKA TVERDOGO TELA
FLORA	FLORA
FLUORIDE	FLUORIDE OFFICIAL QUARTERLY JOURNAL OF INTERNATIONAL SOCIETY FOR FLUORIDE RESEARCH
FOL BIOL	FOLIA BIOLOGICA
FOL ENDOC J	FOLIA ENDOCRINOLOGICA JAPONICA
FOL HIST CY	FOLIA HISTOCHEMICA ET CYTOCHEMICA
FOL MICROB	FOLIA MICROBIOLOGICA
FOL PHARM J	FOLIA PHARMACOLOGICA JAPONICA
FOL PRIMAT	FOLIA PRIMATOLOGICA
FONDERIE FR	FONDERIE, FRANCE
FOOD COSMET	FOOD AND COSMETICS TOXICOLOGY
FOOD ENG	FOOD ENGINEERING
FOOD MANUF	FOOD MANUFACTURE
FOOD TECHN	FOOD TECHNOLOGY
FOREIGN AGR	FOREIGN AGRICULTURE
FOREST CHRO	FORESTRY CHRONICLE
FOREST SCI	FOREST SCIENCE
FORESTRY	FORESTRY
FORTSC GEB	FORSCHRITTE DER GEBURSHILFE UND GYNAEKOLOGIE
FORTSCHR PH	FORTSCHRITTE DER PHYSIK
FOUND LANG	FOUNDATIONS OF LANGUAGE
FOUND PHYS	FOUNDATIONS OF PHYSICS
FRESHW BIOL	FRESHWATER BIOLOGY
FRONT LIBR	FRONTIERS OF LIBRARIANSHIP SYRACUSE UNIVERSITY
FUEL	FUEL
G FIS SANIT	GIORNALE DI FISICA SANITARIA E PROTEZIONE CONTRO LE RADIAZIONI
GANN	GANN
GASLINI	GASLINI
GASTROENTY	GASTROENTEROLOGY
GAZ CHRM IT	GAZZETTA CHIMICA ITALIANA
GEN C ENDOC	GENERAL AND COMPARATIVE ENDOCRINOLOGY
GEN SYST	GENERAL SYSTEMS BULLETIN
GENET IBER	GENETICA IBERICA
GENET POL	GENETICA POLONICA
GENET PSYCH	GENETIC PSYCHOLOGY MONOGRAPHS
GENET RES	GENETICAL RESEARCH
GENETICA	GENETICA
GENETICS	GENETICS
GENETIKA	GENETIKA
GEOCH COS A	GEOCHIMICA ET COSMOCHIMICA ACTA
GEODERMA	GEODERMA
GEOEXPLOR	GEOEXPLORATION
GEOGR J	GEOGRAPHICAL JOURNAL
GEOKHIMIYA	GEOKHIMIYA
GEOL MAG	GEOLOGICAL MAGAZINE
GEOL S AM B	GEOLOGICAL SOCIETY OF AMERICA BULLETIN
GEOPHYS J R	GEOPHYSICAL JOURNAL OF THE ROYAL ASTRONOMICAL SOCIETY
GEOPHYSICS	GEOPHYSICS
GEOSCI CAN	GEOSCIENCE CANADA
GEOTECHNIQ	GEOTECHNIQUE
GERIATRICS	GERIATRICS
GERONT CLIM	GERONTOLOGIA CLINICA
GERONTOL	GERONTOLOGIST
GERONTOLOG	GERONTOLOGIA
GIOR GERONT	GIORNALE DI GERONTOLOGIA
GIOR MICROB	GIORNALE DI MICROBIOLOGIA
GLAS MATH J	GLASGOW MATHEMATICAL JOURNAL
GLASS TECH	GLASS TECHNOLOGY

ISI ABBREVIATION	FULL TITLE
GROUND WAT	GROUND WATER AGE
GROWTH	GROWTH
GUT	GUT
GYNAKOLOGE	GYNAKOLOGE
GYNECOL INV	GYNECOLOGIC INVESTIGATIO
H-S Z PHYSL	HOPPE-SEYLER'S ZEITSCHRIFT FUR PHYSIOLOGISCHE CHEMIE
HAEMOSTASIS	HAEMOSTASIS
HAUTARZT	HAUTARZT
HEADACHE	HEADACHE
HEALTH LAB	HEALTH LABORATORY SCIENCE
HEALTH PHYS	HEALTH PHYSICS
HELG W MEER	HELGOLANDER WISSENSCHAFTLICHE MEERESUNTERSUCHUNGEN
HELV CHIM A	HELVETICA CHIMICA ACTA
HELV CHIR A	HELVETICA CHIRURGICA ACTA
HELV ODOM A	HELVETICA ODONTOLOGICA ACTA
HELV PAED A	HELVETICA PAEDIATRICA ACTA
HELV PHYS A	HELVETICA PHYSICA ACTA
HEREDITAS	HEREDITAS, GENETISKT ARKIV
HEREDITY	HEREDITY
HERZ KREISL	HERZ KREISLAUF
HIGH TEMP R	HIGH TEMPERATURE, USSR
HIGH TEMP S	HIGH TEMPERATURE SCIENCE
HIGHW ENG	HIGHWAY ENGINEER
HILGARDIA	HILGARDIA
HIROS J MED	HIROSHIMA JOURNAL OF MEDICAL SCIENCES
HISTOCHEM J	HISTOCHEMICAL JOURNAL
HISTOCHEMIS	HISTOCHEMISTRY
HMO WEG FAC	HMO, WEGWEISER FUR DIE FACHARZTLICHE PRAXIS
HOLZ ROH WE	HOLZ ALS ROH- UND WERKSTOFF
HOLZF HOLZV	HOLZFORSCHUNG UND HOLZVERWERTUNG
HOLZFORSCH	HOLZFORSCHUNG
HORMONE BEH	HORMONES AND BEHAVIOR
HORMONE MET	HORMONE AND METABOLIC RESEARCH
HORMONE RES	HORMONE RESEARCH
HORT RES	HORTICULTURAL RESEARCH
HORTICULT	HORTICULTURE
HUMAN BIOL	HUMAN BIOLOGY
HUMAN OEV	HUMAN DEVELOPMENT
HUMAN FACT	HUMAN FACTORS
HUMAN HERED	HUMAN HEREDITY
HUMAN PATH	HUMAN PATHOLOGY
HUMANGENET	HUMANGENETIK
HYDRA PNEUM	HYDRAULICS AND PNEUMATICS
HYDROBIOL	HYDROBIOLOGIA
HYDROC PROC	HYDROCARBON PROCESSING
I J AGR SCI	INDIAN JOURNAL OF AGRICULTURAL SCIENCES
I J BIOCH B	INDIAN JOURNAL OF BIOCHEMISTRY AND BIOPHYSICS
I J CHEM	INDIAN JOURNAL OF CHEMISTRY
I J EX BIOL	INDIAN JOURNAL OF EXPERIMENTAL BIOLOGY
I J GENET P	INDIAN JOURNAL OF GENETICS AND PLANT BREEDING
I J MED RES	INDIAN JOURNAL OF MEDICAL RESEARCH
I J NUTR D	INDIAN JOURNAL OF NUTRITION AND DIETETICS
I J PA PHYS	INDIAN JOURNAL OF PURE AND APPLIED PHYSICS

ISI ABBREVIATION	FULL TITLE
I J PHYSICS	INDIAN JOURNAL OF PHYSICS AND PROCEEDINGS OF THE INDIAN ASSOCIATION FOR THE CULTIVATION OF SCIENCE
I J PSYCHOL	INDIAN JOURNAL OF PSYCHOLOGY
I J TECHN	INDIAN JOURNAL OF TECHNOLOGY
I J THEOR P	INDIAN JOURNAL OF THEORETICAL PHYSICS
IAN SSS BIO	IZVESTIYA AKADEMI NAUK SSSR SERIYA BIOLOGICHESKAYA
IAN SSS FAO	IZVESTIYA AKADEMI NAUK SSSR FIZIKA ATMOSFERY I OKEANA
IAN SSS FIZ	IZVESTIYA AKADEMI NAUK SSSR SERIYA FIZICHESKAYA
IAN SSS KH	IZVESTIYA AKADEMI NAUK SSSR SERIYA KHIMICHESKAYA
IBIS	IBIS
IBM J RES	IBM JOURNAL OF RESEARCH AND DEVELOPMENT
IBM SYST J	IBM SYSTEMS JOURNAL
ICARUS	ICARUS
IEEE ACOUST	IEEE TRANSACTIONS ON ACOUSTICS SPEECH AND SIGNAL PROCESSING
IEEE AER EL	IEEE TRANSACTIONS ON AEROSPACE AND ELECTRONIC SYSTEMS
IEEE ANTENN	IEEE TRANSACTIONS ON ANTENNAS AND PROPAGATION
IEEE AUTO C	IEEE TRANSACTIONS ON AUTOMATIC CONTROL
IEEE B TELE	IEEE TRANSACTIONS ON BROADCAST AND TELEVISION RECEIVERS
IEEE BIOMED	IEEE TRANSACTIONS ON BIO-MEDICAL ENGINEERING
IEEE BROADC	IEEE TRANSACTIONS ON BROADCASTING
IEEE CIRC S	IEEE TRANSACTIONS ON CIRCUITS AND SYSTEMS
IEEE COMMUN	IEEE TRANSACTIONS ON COMMUNICATIONS
IEEE COMPUT	IEEE TRANSACTIONS ON COMPUTERS
IEEE DEVICE	IEEE TRANSACTIONS ON ELECTRON DEVICES
IEEE EDUCAT	IEEE TRANSACTIONS ON EDUCATION
IEEE EL INS	IEEE TRANSACTIONS ON ELECTRICAL INSULATION
IEEE ELM CS	IEEE ELECTROMAGNETIC COMPATIBILITY SYMPOSIA, RECORDS
IEEE GEOSCI	IEEE TRANSACTIONS ON GEOSCIENTIFIC ELECTRONICS
IEEE IND AP	IEEE TRANSACTIONS ON INDUSTRY APPLICATIONS
IEEE IND EL	IEEE TRANSACTIONS ON INDUSTRIAL ELECTRONICS AND CONTROL INSTRUMENTATION
IEEE INFO T	IEEE TRANSACTIONS ON INFORMATION THEORY
IEEE INSTR	IEEE TRANSACTIONS ON INSTRUMENTATION AND MEASUREMENT
IEEE J Q EL	IEEE JOURNAL OF QUANTUM ELECTRONICS
IEEE J SOLI	IEEE JOURNAL OF SOLID STATE CIRCUITS
IEEE MAGNET	IEEE TRANSACTIONS ON MAGNETICS
IEEE MANAGE	IEEE TRANSACTIONS ON ENGINEERING MANAGEMENT
IEEE MICR T	IEEE TRANSACTIONS ON MICROWAVE THEORY AND TECHNIQUES
IEEE NUCL S	IEEE TRANSACTIONS ON NUCLEAR SCIENCE
IEEE PARTS	IEEE TRANSACTIONS ON PARTS HYBRIDS AND PACKAGING
IEEE POWER	IEEE TRANSACTIONS ON POWER APPARATUS AND SYSTEMS
IEEE PROF C	IEEE TRANSACTIONS ON PROFESSIONAL COMMUNICATION
IEEE RELIAB	IEEE TRANSACTIONS ON RELIABILITY
IEEE SON UL	IEEE TRANSACTIONS ON SONICS AND ULTRASONICS
IEEE SPECTR	IEEE SPECTRUM

ISI ABBREVIATION	FULL TITLE
IEEE SYST M	IEEE TRANSACTIONS ON SYSTEMS MAN AND CYBERNETICS
IEEE VEH T	IEEE TRANSACTIONS ON VEHICULAR TECHNOLOGY
IIRB	IIRB
ILL J MATH	ILLINOIS JOURNAL OF MATHEMATICS
IMMUNOCHEM	IMMUNOCHEMISTRY
IMMUNOGENET	IMMUNOGENETICS
IMMUNOL COM	IMMUNOLOGICAL COMMUNICATIONS
IMMUNOLOGY	IMMUNOLOGY
IMPACT SCI	IMPACT OF SCIENCE ON SOCIETY
IN VITRO	IN VITRO JOURNAL OF THE TISSUE CULTURE ASSOCIATION
IND CHIM BE	INDUSTRIE CHIMIQUE BELGE BELGISCHE CHEMISCHE INDUSTRIE
IND DIAM RE	INDUSTRIAL DIAMOND REVIEW
IND ENG	INDUSTRIAL ENGINEERING
IND ENG F	INDUSTRIAL AND ENGINEERING CHEMISTRY FUNDAMENTALS
IND ENG POD	INDUSTRIAL AND ENGINEERING CHEMISTRY PROCESS DESIGN AND DEVELOPMENT
IND ENG PRD	INDUSTRIAL AND ENGINEERING CHEMISTRY PRODUCT RESEARCH AND DEVELOPMENT
IND FINISH	INDUSTRIAL FINISHING
IND LAB R	INDUSTRIAL LABORATORY USSR
IND PHOTOGR	INDUSTRIAL PHOTOGRAPHY
IND RES	INDUSTRIAL RESEARCH
INDI MATH J	INDIANA UNIVERSITY MATHEMATICS JOURNAL
INF CONTR	INFORMATION AND CONTROL
INF SCI	INFORMATION SCIENCES
INF SCIENT	INFORMATION SCIENTIST
INF STORAGE	INFORMATION STORAGE AND RETRIEVAL
INFEC IMMUN	INFECTION AND IMMUNITY
INFRAR PHYS	INFRARED PHYSICS
ING ARCH	INGENIEURARCHIV
ING CHIM IT	QUADERNI DELL'INGEGNERE CHIMICO
INJURY	INJURY THE BRITISH JOURNAL OF ACCIDENT SURGERY
INORG CHEM	INORGANIC CHEMISTRY
INORG CHIM	INORGANICA CHIMICA ACTA
INDRG NUCL	INORGANIC AND NUCLEAR CHEMISTRY LETTERS
INSECT BIOC	INSECT BIOCHEMISTRY
INSECT SOC	INSECTES SOCIALE
INSTR CONTR	INSTRUMENTS AND CONTROL SYSTEMS
INSTR TECH	INSTRUMENTATION TECHNOLOGY
INSTRUMENT	INSTRUMENTATION
INT A ALLER	INTERNATIONAL ARCHIVES OF ALLERGY AND APPLIED IMMUNOLOGY
INT A ARB	INTERNATIONALES ARCHIV FUR ARBEITSMEDIZIN
INT BIOD B	INTERNATIONAL BIODETERIORATION BULLETIN
INT CHEM EN	INTERNATIONAL CHEMICAL ENGINEERING
INT DENT J	INTERNATIONAL DENTAL JOURNAL
INT ELEKTR	INTERNATIONALE ELEKTRONISCHE RUNDSCHAU
INT HYD REV	INTERNATIONAL HYDROGRAPHIC REVIEW
INT J A AFF	INTERNATIONAL JOURNAL OF AGRARIAN AFFAIRS
INT J A RAD	INTERNATIONAL JOURNAL OF APPLIED RADIATION AND ISOTOPIES
INT J ADDIC	INTERNATIONAL JOURNAL OF THE ADDICTIONS
INT J BIOC	INTERNATIONAL JOURNAL OF BIOCHEMISTRY
INT J BIOM	INTERNATIONAL JOURNAL OF BIOMETEOROLOGY

ISI ABBREVIATION	FULL TITLE
INT J CANC	INTERNATIONAL JOURNAL OF CANCER
INT J CE HY	INTERNATIONAL JOURNAL OF CLINICAL AND EXPERIMENTAL HYPNOSIS
INT J CH K	INTERNATIONAL JOURNAL OF CHEMICAL KINETICS
INT J CL PH	INTERNATIONAL JOURNAL OF CLINICAL PHARMACOLOGY, THERAPY AND TOXICOLOGY
INT J COM M	INTERNATIONAL JOURNAL OF COMPUTER MATHEMATICS
INT J CONTR	INTERNATIONAL JOURNAL OF CONTROL
INT J EL EN	INTERNATIONAL JOURNAL OF ELECTRICAL ENGINEERING EDUCATION
INT J ELECT	INTERNATIONAL JOURNAL OF ELECTRONICS
INT J ENG S	INTERNATIONAL JOURNAL OF ENGINEERING SCIENCE
INT J FERT	INTERNATIONAL JOURNAL OF FERTILITY
INT J FRACT	INTERNATIONAL JOURNAL OF FRACTURE
INT J GRP P	INTERNATIONAL JOURNAL OF GROUP PSYCHOTHERAPY
INT J HEAT	INTERNATIONAL JOURNAL OF HEAT AND MASS TRANSFER
INT J MACH	INTERNATIONAL JOURNAL OF MACHINE TOOL DESIGN AND RESEARCH
INT J MECH	INTERNATIONAL JOURNAL OF MECHANICAL SCIENCES
INT J NEURO	INTERNATIONAL JOURNAL OF NEUROLOGY
INT J NEURS	INTERNATIONAL JOURNAL OF NEUROSCIENCE
INT J OCC H	INTERNATIONAL JOURNAL OF OCCUPATIONAL HEALTH AND SAFETY
INT J PEPT	INTERNATIONAL JOURNAL OF PEPTIDE AND PROTEIN RESEARCH
INT J POWD	INTERNATIONAL JOURNAL OF POWDER METALLURGY AND POWDER TECHNOLOGY
INT J PSYCH	INTERNATIONAL JOURNAL OF PSYCHO-ANALYSIS
INT J QUANT	INTERNATIONAL JOURNAL OF QUANTUM CHEMISTRY
INT J RAD B	INTERNATIONAL JOURNAL OF RADIATION BIOLOGY AND RELATED STUDIES IN PHYSICS, CHEMISTRY AND MEDICINE
INT J RAD P	INTERNATIONAL JOURNAL FOR RADIATION PHYSICS AND CHEMISTRY
INT J ROCK	INTERNATIONAL JOURNAL OF ROCK MECHANICS AND MINING SCIENCES
INT J SY B	INTERNATIONAL JOURNAL OF SYSTEMATIC BACTERIOLOGY
INT J SYST	INTERNATIONAL JOURNAL OF SYSTEMS SCIENCE
INT J THEOR	INTERNATIONAL JOURNAL OF THEORETICAL PHYSICS
INT J VIT N	INTERNATIONAL JOURNAL FOR VITAMIN AND NUTRITION RESEARCH
INT PHARMAC	INTERNATIONAL PHARMACOPSYCHIATRY
INT REV CYT	INTERNATIONAL REVIEW OF CYTOLOGY
INT STAT R	INTERNATIONAL STATISTICAL REVIEW
INTERNIST	INTERNIST
INTERVIROLO	INTERVIROLOGY
INV OPHTH	INVESTIGATIVE OPHTHALMOLOGY
INV PESQ	INVESTIGACION PESQUERA
INV RADIOD	INVESTIGATIVE RADIOLOGY
INV UROL	INVESTIGATIVE UROLOGY
INVENT MATH	INVENTIONES MATHEMATICAE
IRISH ASTR	IRISH ASTRONOMICAL JOURNAL
IRISH J AGR	IRISH JOURNAL OF AGRICULTURAL RESEARCH
IRISH J MEO	IRISH JOURNAL OF MEDICAL SCIENCE
IRISH MED J	IRISH MEDICAL JOURNAL
IRRAD ALIM	IRRADIATION DES ALIMENTS
ISA TRANS	ISA TRANSACTIONS
ISR J BOT	ISRAEL JOURNAL OF BOTANY

ISI ABBREVIATION	FULL TITLE
ISR J CHEM	ISRAEL JOURNAL OF CHEMISTRY
ISR J EARTH	ISRAEL JOURNAL OF EARTH SCIENCES
ISR J MATH	ISRAEL JOURNAL OF MATHEMATICS
ISR J MED S	ISRAEL JOURNAL OF MEDICAL SCIENCES
ISR J TECH	ISRAEL JOURNAL OF TECHNOLOGY
ISR J ZOO	ISRAEL JOURNAL OF ZOOLOGY
ITAL J BIOC	ITALIAN JOURNAL OF BIOCHEMISTRY
IVUZ FIZ	IZVESTIYA VYSSHIKH UCHEBNIKH ZAVEDENII FIZIKA
J ABN PSYCH	JOURNAL OF ABNORMAL PSYCHOLOGY AND SUPPLEMENT
J ACM	JOURNAL OF THE ASSOCIATION FOR COMPUTING MACHINERY
J ACOUST SO	JOURNAL OF THE ACOUSTICAL SOCIETY OF AMERICA
J ADHESION	JOURNAL OF ADHESION
J AGR CHE J	JOURNAL OF THE AGRICULTURAL CHEMICAL SOCIETY OF JAPAN
J AGR ENG R	JOURNAL OF AGRICULTURAL ENGINEERING RESEARCH
J AGR FOOD	JOURNAL OF AGRICULTURAL AND FOOD CHEMISTRY
J AGR SCI	JOURNAL OF AGRICULTURAL SCIENCE
J AIR POLLU	JOURNAL OF THE AIR POLLUTION CONTROL ASSOCIATION
J ALB EIN M	JOURNAL OF THE ALBERT EINSTEIN MEDICAL CENTER
J ALGEBRA	JOURNAL OF ALGEBRA
J ALLERG CL	JOURNAL OF ALLERGY AND CLINICAL IMMUNOLOGY
J AM A CHIL	JOURNAL OF THE AMERICAN ACADEMY OF CHILD PSYCHIATRY
J AM CERAM	JOURNAL OF THE AMERICAN CERAMIC SOCIETY
J AM CHEM S	JOURNAL OF THE AMERICAN CHEMICAL SOCIETY
J AM DENT A	JOURNAL OF THE AMERICAN DENTAL ASSOCIATION
J AM DIET A	JOURNAL OF THE AMERICAN DIETETIC ASSOCIATION
J AM GER SO	JOURNAL OF THE AMERICAN GERIATRICS SOCIETY
J AM LEATH	JOURNAL OF THE AMERICAN LEATHER CHEMISTS ASSOCIATION
J AM MED A	JOURNAL OF THE AMERICAN MEDICAL ASSOCIATION
J AM OIL CH	JOURNAL OF THE AMERICAN OIL CHEMISTS SOCIETY
J AM PHARM	JOURNAL OF THE AMERICAN PHARMACEUTICAL ASSOCIATION
J AM S HORT	JOURNAL OF THE AMERICAN SOCIETY FOR HORTICULTURAL SCIENCE
J AM S INFO	JOURNAL OF THE AMERICAN SOCIETY FOR INFORMATION SCIENCE
J AM S SUG	JOURNAL OF THE AMERICAN SOCIETY OF SUGAR BEET TECHNOLOGISTS
J AM STAT A	JOURNAL OF THE AMERICAN STATISTICAL ASSOCIATION
J AM VET ME	JOURNAL OF THE AMERICAN VETERINARY MEDICAL ASSOCIATION
J AM VET RA	JOURNAL OF THE AMERICAN VETERINARY RADIOLOGY SOCIETY
J AM WATER	JOURNAL OF THE AMERICAN WATER WORKS ASSOCIATION
J ANAL MATH	JOURNAL D'ANALYSE MATHEMATIQUE
J ANAL PSYC	JOURNAL OF ANALYTICAL PSYCHOLOGY
J ANAT	JOURNAL OF ANATOMY
J ANIM ECOL	JOURNAL OF ANIMAL ECOLOGY
J ANIM SCI	JOURNAL OF ANIMAL SCIENCE
J ANTIBIOT	JOURNAL OF ANTIBIOTICS
J AOAC	JOURNAL OF THE ASSOCIATION OF OFFICIAL ANALYTICAL CHEMISTS
J APP PHYSL	JOURNAL OF APPLIED PHYSIOLOGY
J APPL BACT	JOURNAL OF APPLIED BACTERIOLOGY
J APPL BE A	JOURNAL OF APPLIED BEHAVIOR ANALYSIS

ISI ABBREVIATION	FULL TITLE
J APPL BEH	JOURNAL OF APPLIED BEHAVIORAL SCIENCE
J APPL CH B	JOURNAL OF APPLIED CHEMISTRY AND BIOTECHNOLOGY
J APPL CRY	JOURNAL OF APPLIED CRYSTALLOGRAPHY
J APPL ECOL	JOURNAL OF APPLIED ECOLOGY
J APPL ELEC	JOURNAL OF APPLIED ELECTROCHEMISTRY
J APPL MECH	JOURNAL OF APPLIED MECHANICS
J APPL MET	JOURNAL OF APPLIED METEOROLOGY
J APPL PHYS	JOURNAL OF APPLIED PHYSICS
J APPL POLY	JOURNAL OF APPLIED POLYMER SCIENCE
J APPL PROB	JOURNAL OF APPLIED PROBABILITY
J APPL PSYC	JOURNAL OF APPLIED PSYCHOLOGY AND MONOGRAPH
J ARN ARBOR	JOURNAL OF THE ARNOLD ARBORETUM
J ASTRONAUT	JOURNAL OF THE ASTRONAUTICAL SCIENCES
J ATM TER P	JOURNAL OF ATMOSPHERIC AND TERRESTRIAL PHYSICS
J ATMOS SCI	JOURNAL OF THE ATMOSPHERIC SCIENCES
J AUD ENG S	JOURNAL OF THE AUDIO ENGINEERING SOCIETY
J AUS I AGR	JOURNAL OF THE AUSTRALIAN INSTITUTE OF AGRICULTURAL SCIENCE
J AUS I MET	JOURNAL OF THE AUSTRALIAN INSTITUTE OF METALS
J BACT	JOURNAL OF BACTERIOLOGY
J BELG RAD	JOURNAL BELGE DE RADIOLOGIE
J BIOCHEM	JOURNAL OF BIOCHEMISTRY
J BIOENERG	JOURNAL OF BIOENERGETICS
J BIOL BUCC	JOURNAL DE BIOLOGIE BUCCALE
J BIOL CHEM	JOURNAL OF BIOLOGICAL CHEMISTRY
J BIOL PHOT	JOURNAL OF THE BIOLOGICAL PHOTOGRAPHIC ASSOCIATION
J BIOL STAN	JOURNAL OF BIOLOGICAL STANDARDIZATION
J BIOMECHAN	JOURNAL OF BIOMECHANICS
J BIOMED MR	JOURNAL OF BIOMEDICAL MATERIALS RESEARCH
J BIOSOC SC	JOURNAL OF BIOSOCIAL SCIENCE
J BONE-AM V	JOURNAL OF BONE AND JOINT SURGERY-AMERICAN VOLUME
J BONE-BR V	JOURNAL OF BONE AND JOINT SURGERY-BRITISH VOLUME
J BR GRASSL	JOURNAL OF THE BRITISH GRASSLAND SOCIETY
J BR NUCL E	JOURNAL OF THE BRITISH NUCLEAR ENERGY SOCIETY
J BRYOL	JOURNAL OF BRYOLOGY
J CAN PET T	JOURNAL OF CANADIAN PETROLEUM TECHNOLOGY
J CARB-NUCL	JOURNAL OF CARBOHYDRATES, NUCLEOSIDES, NUCLEOTIDES
J CARD SURG	JOURNAL OF CARDIOVASCULAR SURGERY
J CATALYSIS	JOURNAL OF CATALYSIS
J CELL BIOL	JOURNAL OF CELL BIOLOGY
J CELL PHYS	JOURNAL OF CELLULAR PHYSIOLOGY
J CELL SCI	JOURNAL OF CELL SCIENCE
J CHEM DOC	JOURNAL OF CHEMICAL DOCUMENTATION
J CHEM EDUC	JOURNAL OF CHEMICAL EDUCATION
J CHEM EN D	JOURNAL OF CHEMICAL AND ENGINEERING DATA
J CHEM PHYS	JOURNAL OF CHEMICAL PHYSICS
J CHEM S CH	JOURNAL OF THE CHEMICAL SOCIETY CHEMICAL COMMUNICATIONS
J CHEM S DA	JOURNAL OF THE CHEMICAL SOCIETY DALTON TRANSACTIONS
J CHEM S F1	JOURNAL OF THE CHEMICAL SOCIETY FARADAY TRANSACTIONS I

ISI ABBREVIATION	FULL TITLE
J CHEM S F2	JOURNAL OF THE CHEMICAL SOCIETY FARADAY TRANSACTIONS II
J CHEM S P1	JOURNAL OF THE CHEMICAL SOCIETY PERKIN TRANSACTIONS I
J CHEM S P2	JOURNAL OF THE CHEMICAL SOCIETY PERKIN TRANSACTIONS II
J CHEM THER	JOURNAL OF CHEMICAL THERMODYNAMICS
J CHILD PSY	JOURNAL OF CHILD PSYCHOLOGY AND PSYCHIATRY AND ALLIED DISCIPLINES
J CHIM PHYS	JOURNAL DE CHIMIE PHYSIQUE ET DE PHYSICO-CHIMIE BIOLOGIQUE
J CHIN CHEM	JOURNAL OF THE CHINESE CHEMICAL SOCIETY
J CHIR	JOURNAL DE CHIRURGIE
J CHROM SCI	JOURNAL OF CHROMATOGRAPHIC SCIENCE
J CHROMAT	JOURNAL OF CHROMATOGRAPHY
J CHRON DIS	JOURNAL OF CHRONIC DISEASES
J CLIN END	JOURNAL OF CLINICAL ENDOCRINOLOGY AND METABOLISM
J CLIN INV	JOURNAL OF CLINICAL INVESTIGATION
J CLIN PATH	JOURNAL OF CLINICAL PATHOLOGY
J CLIN PHAR	JOURNAL OF CLINICAL PHARMACOLOGY
J CLIN PSYC	JOURNAL OF CLINICAL PSYCHOLOGY
J COLL I SC	JOURNAL OF COLLOID AND INTERFACE SCIENCE
J COM PHYSL	JOURNAL OF COMPARATIVE AND PHYSIOLOGICAL PSYCHOLOGY AND SUPPLEMENT
J COMP NEUR	JOURNAL OF COMPARATIVE NEUROLOGY
J COMP PATH	JOURNAL OF COMPARATIVE PATHOLOGY
J COMP PHYS	JOURNAL OF COMPARATIVE PHYSIOLOGY
J COMPOS MA	JOURNAL OF COMPOSITE MATERIALS
J COMPUT PH	JOURNAL OF COMPUTATIONAL PHYSICS
J COMPUT SY	JOURNAL OF COMPUTER AND SYSTEM SCIENCES
J CONFI. RES	JOURNAL OF CONFLICT RESOLUTION
J CONS ASCE	JOURNAL OF THE CONSTRUCTION DIVISION-ASCE
J CONS CLIN	JOURNAL OF CONSULTING AND CLINICAL PSYCHOLOGY AND SUPPLEMENT
J CONSEIL	JOURNAL DU CONSEIL
J COUN PSYC	JOURNAL OF COUNSELING PSYCHOLOGY
J CRYST GR	JOURNAL OF CRYSTAL GROWTH
J CUT PATH	JOURNAL OF CUTANEOUS PATHOLOGY
J DAIRY RES	JOURNAL OF DAIRY RESEARCH
J DAIRY SCI	JOURNAL OF DAIRY SCIENCE
J DENT RES	JOURNAL OF DENTAL RESEARCH
J DIFF EQUA	JOURNAL OF DIFFERENTIAL EQUATIONS
J DOC	JOURNAL OF DOCUMENTATION
J ECOLOGY	JOURNAL OF ECOLOGY
J ECON ENT	JOURNAL OF ECONOMIC ENTOMOLOGY
J EDUC LIBR	JOURNAL OF EDUCATION FOR LIBRARIANSHIP
J EDUC PSYC	JOURNAL OF EDUCATIONAL PSYCHOLOGY AND SUPPLEMENT
J ELAST	JOURNAL OF ELASTICITY
J ELCARDIOL	JOURNAL OF ELECTROCARDIOLOGY
J ELCHEM SO	JOURNAL OF THE ELECTROCHEMICAL SOCIETY
J ELEC CHEM	JOURNAL OF ELECTROANALYTICAL CHEMISTRY AND INTERFACIAL ELECTROCHEMISTRY
J ELEC MAT	JOURNAL OF ELECTRONIC MATERIALS
J ELEC MICR	JOURNAL OF ELECTRON MICROSCOPY
J ELEC SPEC	JOURNAL OF ELECTRON SPECTROSCOPY
J EMB EXP M	JOURNAL OF EMBRYOLOGY AND EXPERIMENTAL MORPHOLOGY
J ENDOCR	JOURNAL OF ENDOCRINOLOGY
J ENG IND	JOURNAL OF ENGINEERING FOR INDUSTRY

ISI ABBREVIATION	FULL TITLE
J ENG MATER	JOURNAL OF ENGINEERING MATERIALS AND TECHNOLOGY
J ENG MATH	JOURNAL OF ENGINEERING MATHEMATICS
J ENG MECH	JOURNAL OF THE ENGINEERING MECHANICS DIVISION-ASCE
J ENG POWER	JOURNAL OF ENGINEERING FOR POWER
J ENTOMOL A	JOURNAL OF ENTOMOLOGY SERIES A GENERAL ENTOMOLOGY
J ENTOMOL B	JOURNAL OF ENTOMOLOGY SERIES B TAXONOMY
J ENVIR ENG	JOURNAL OF THE ENVIRONMENTAL ENGINEERING DIVISION-ASCE
J ENVIR MGM	JOURNAL OF ENVIRONMENTAL MANAGEMENT
J ENVIR Q	JOURNAL OF ENVIRONMENTAL QUALITY
J ENVIR SCI	JOURNAL OF ENVIRONMENTAL SCIENCES
J EX AN BEH	JOURNAL OF THE EXPERIMENTAL ANALYSIS OF BEHAVIOR
J EXP BIOL	JOURNAL OF EXPERIMENTAL BIOLOGY
J EXP BOT	JOURNAL OF EXPERIMENTAL BOTANY
J EXP C PSY	JOURNAL OF EXPERIMENTAL CHILD PSYCHOLOGY
J EXP MAR B	JOURNAL OF EXPERIMENTAL MARINE BIOLOGY AND ECOLOGY
J EXP MED	JOURNAL OF EXPERIMENTAL MEDICINE
J EXP PSYCH	JOURNAL OF EXPERIMENTAL PSYCHOLOGY AND MONOGRAPH
J EXP S PSY	JOURNAL OF EXPERIMENTAL SOCIAL PSYCHOLOGY
J EXP ZOO	JOURNAL OF EXPERIMENTAL ZOOLOGY
J FAC TOK 1	JOURNAL OF THE FACULTY OF SCIENCE UNIVERSITY OF TOKYO SECTION 1 MATHEMATICS ASTRONOMY, PHYSICS CHEMISTRY
J FERM TECH	JOURNAL OF FERMENTATION TECHNOLOGY
J FISH BIOL	JOURNAL OF FISH BIOLOGY
J FISH RES	JOURNAL OF THE FISHERIES RESEARCH BOARD OF CANADA
J FLUID ENG	JOURNAL OF FLUIDS ENGINEERING
J FLUID MEC	JOURNAL OF FLUID MECHANICS
J FLUORINE	JOURNAL OF FLUORINE CHEMISTRY
J FOOD SCI	JOURNAL OF FOOD SCIENCE
J FOR SCI	JOURNAL OF THE FORENSIC SCIENCE SOCIETY
J FORESTRY	JOURNAL OF FORESTRY
J FRANKL I	JOURNAL OF THE FRANKLIN INSTITUTE
J GEN A MIC	JOURNAL OF GENERAL AND APPLIED MICROBIOLOGY
J GEN A MICRO	JOURNAL OF GENERAL MICROBIOLOGY
J GEN PHYSI	JOURNAL OF GENERAL PHYSIOLOGY
J GEN PSYCH	JOURNAL OF GENERAL PSYCHOLOGY
J GEN VIROL	JOURNAL OF GENERAL VIROLOGY
J GENET HUM	JOURNAL DE GENETIQUE HUMAINE
J GENET PSY	JOURNAL OF GENETIC PSYCHOLOGY
J GENETICS	JOURNAL OF GENETICS
J GEOL S IN	JOURNAL OF THE GEOLOGICAL SOCIETY OF INDIA
J GEOLOGY	JOURNAL OF GEOLOGY
J GEOMAGN G	JOURNAL OF GEOMAGNETISM AND GEOELECTRICITY
J GEOPH RES	JOURNAL OF GEOPHYSICAL RESEARCH
J GEOPHYS	JOURNAL OF GEOPHYSICS ZEITSCHRIFT FUR GEOPHYSIK
J GERONTOL	JOURNAL OF GERONTOLOGY
J HEAT TRAN	JOURNAL OF HEAT TRANSFER
J HELMINTH	JOURNAL OF HELMINTHOLOGY
J HEREDITY	JOURNAL OF HEREDITY
J HETERO CH	JOURNAL OF HETEROCYCLIC CHEMISTRY
J HIST CYTO	JOURNAL OF HISTOCHEMISTRY AND CYTOCHEMISTRY

ISI ABBREVIATION	FULL TITLE
J HORT SCI	JOURNAL OF HORTICULTURAL SCIENCE
J HUM EVOL	JOURNAL OF HUMAN EVOLUTION
J HYDR-ASCE	JOURNAL OF THE HYDRAULICS DIVISION-ASCE
J HYG CAMB	JOURNAL OF HYGIENE CAMBRIDGE
J HYG EP MI	JOURNAL OF HYGIENE EPIDEMIOLOGY MICROBIOLOGY AND IMMUNOLOGY
J I BREWING	JOURNAL OF THE INSTITUTE OF BREWING
J I FUEL	JOURNAL OF THE INSTITUTE OF FUEL
J I NUCL EN	JOURNAL OF THE INSTITUTION OF NUCLEAR ENGINEERS
J I WOOD SC	JOURNAL OF THE INSTITUTE OF WOOD SCIENCE
J IMMUNOL	JOURNAL OF IMMUNOLOGY
J IMMUNOL M	JOURNAL OF IMMUNOLOGICAL METHODS
J IND CH S	JOURNAL OF THE INDIAN CHEMICAL SOCIETY
J INDIAN I	JOURNAL OF THE INDIAN INSTITUTE OF SCIENCE
J INDIV PSY	JOURNAL OF INDIVIDUAL PSYCHOLOGY
J INFEC DIS	JOURNAL OF INFECTIOUS DISEASES
J INORG NUC	JOURNAL OF INORGANIC AND NUCLEAR CHEMISTRY
J INSECT PH	JOURNAL OF INSECT PHYSIOLOGY
J INTERD CY	JOURNAL OF INTERDISCIPLINARY CYCLE RESEARCH
J INVER PAT	JOURNAL OF INVERTEBRATE PATHOLOGY
J INVES DER	JOURNAL OF INVESTIGATIVE DERMATOLOGY
J IRISH C P	JOURNAL OF THE IRISH COLLEGES OF PHYSICIANS AND SURGEONS
J JAP S LUB	JOURNAL OF JAPAN SOCIETY OF LUBRICATION ENGINEERS
J L TEMP PH	JOURNAL OF LOW TEMPERATURE PHYSICS
J LA CL MED	JOURNAL OF LABORATORY AND CLINICAL MEDICINE
J LABEL COM	JOURNAL OF LABELLED COMPOUND
J LESSC MET	JOURNAL OF THE LESS COMMON METALS
J LIBR AUT	JOURNAL OF LIBRARY AUTOMATION
J LIPID RES	JOURNAL OF LIPID RESEARCH
J LOND MATH	JOURNAL OF THE LONDON MATHEMATICAL SOCIETY
J LUB TECH	JOURNAL OF LUBRICATION TECHNOLOGY
J MACR S CH	JOURNAL OF MACROMOLECULAR SCIENCE CHEMISTRY
J MACR S PH	JOURNAL OF MACROMOLECULAR SCIENCE PHYSICS
J MACR S RM	JOURNAL OF MACROMOLECULAR SCIENCE REVIEWS IN MACROMOLECULAR CHEMISTRY
J MAGN RES	JOURNAL OF MAGNETIC RESONANCE
J MAMMAL	JOURNAL OF MAMMALOGY
J MARINE BI	JOURNAL OF THE MARINE BIOLOGICAL ASSOCIATION OF THE UNITED KINGDOM
J MARINE RE	JOURNAL OF MARINE RESEARCH
J MATER SCI	JOURNAL OF MATERIALS SCIENCE
J MATH ANAL	JOURNAL OF MATHEMATICAL ANALYSIS AND APPLICATIONS
J MATH BIOL	JOURNAL OF MATHEMATICAL BIOLOGY
J MATH JAP	JOURNAL OF THE MATHEMATICAL SOCIETY OF JAPAN
J MATH P A	JOURNAL DE MATHEMATIQUES PURES ET APPLIQUEES
J MATH PHYS	JOURNAL OF MATHEMATICAL PHYSICS
J MATH PSYC	JOURNAL OF MATHEMATICAL PSYCHOLOGY
J MECANIQUE	JOURNAL DE MECANIQUE

ISI ABBREVIATION	FULL TITLE	ISI ABBREVIATION	FULL TITLE
J MECH ENG	JOURNAL OF MECHANICAL ENGINEERING SCIENCE	J PAINT TEC	JOURNAL OF PAINT TECHNOLOGY
J MECH PHYS	JOURNAL OF THE MECHANICS AND PHYSICS OF SOLIDS	J PALEONTOL	JOURNAL OF PALEONTOLOGY
J MED	JOURNAL OF MEDICINE	J PARASITOL	JOURNAL OF PARASITOLOGY
J MED CHEM	JOURNAL OF MEDICAL CHEMISTRY	J PATHOLOG	JOURNAL OF PATHOLOGY
J MED EDUC	JOURNAL OF MEDICAL EDUCATION	J PED SURG	JOURNAL OF PEDIATRIC SURGERY
J MED ENT	JOURNAL OF MEDICAL ENTOMOLOGY	J PEDIAT	JOURNAL OF PEDIATRICS
J MED GENET	JOURNAL OF MEDICAL GENETICS	J PERIOD RE	JOURNAL OF PERIODONTAL RESEARCH
J MED MICRO	JOURNAL OF MEDICAL MICROBIOLOGY	J PERIODONT	JOURNAL OF PERIODONTOLOGY
J MED PRIM	JOURNAL OF MEDICAL PRIMATOLOGY	J PERS SOC	JOURNAL OF PERSONALITY AND SOCIAL PSYCHOLOGY AND SUPPLEMENT
J MEMBR BIO	JOURNAL OF MEMBRANE BIOLOGY	J PERSONAL	JOURNAL OF PERSONALITY
J MENT DEF	JOURNAL OF MENTAL DEFICIENCY RESEARCH	J PETRO TEC	JOURNAL OF PETROLEUM TECHNOLOGY
J METALS	JOURNAL OF METALS	J PETROLOGY	JOURNAL OF PETROLOGY
J MICROSC O	JOURNAL OF MICROSCOPY OXFORD	J PHAR BIOP	JOURNAL OF PHARMACOKINETICS AND BIOPHARMACEUTICS
J MICROSCOP	JOURNAL DE MICROSCOPIE-PARIS	J PHARM EXP	JOURNAL OF PHARMACOLOGY AND EXPERIMENTAL THERAPEUTICS
J MILK FOOD	JOURNAL OF MILK AND FOOD TECHNOLOGY	J PHARM PHA	JOURNAL OF PHARMACY AND PHARMACOLOGY
J MOL BIOL	JOURNAL OF MOLECULAR BIOLOGY	J PHARM SCI	JOURNAL OF PHARMACEUTICAL SCIENCES
J MOL CEL C	JOURNAL OF MOLECULAR AND CELLULAR CARDIOLOGY	J PHARMACOL	JOURNAL DE PHARMACOLOGIE
J MOL EVOL	JOURNAL OF MOLECULAR EVOLUTION	J PHOT SCI	JOURNAL OF PHOTOGRAPHIC SCIENCE
J MOL SPECT	JOURNAL OF MOLECULAR SPECTROSCOPY	J PHYCOLOGY	JOURNAL OF PHYCOLOGY
J MOL STRUC	JOURNAL OF MOLECULAR STRUCTURE	J PHYS A	JOURNAL OF PHYSICS PART A MATHEMATICAL NUCLEAR AND GENERAL
J MORPH	JOURNAL OF MORPHOLOGY	J PHYS B	JOURNAL OF PHYSICS PART B ATOMIC AND MOLECULAR PHYSICS
J NAT CANC	JOURNAL OF THE NATIONAL CANCER INSTITUTE	J PHYS C	JOURNAL OF PHYSICS PART C SOLID STATE PHYSICS AND SUPPLEMENT
J NAT HIST	JOURNAL OF NATURAL HISTORY	J PHYS CH S	JOURNAL OF PHYSICS AND CHEMISTRY OF SOLIDS
J NAVIG	JOURNAL OF NAVIGATION	J PHYS CHEM	JOURNAL OF PHYSICAL CHEMISTRY
J NE EXP NE	JOURNAL OF NEUROPATHOLOGY AND EXPERIMENTAL NEUROLOGY	J PHYS D	JOURNAL OF PHYSICS PART D APPLIED PHYSICS
J NE NE PSY	JOURNAL OF NEUROLOGY NEUROSURGERY AND PSYCHIATRY	J PHYS E	JOURNAL OF PHYSICS PART E SCIENTIFIC INSTRUMENTS
J NEMATOL	JOURNAL OF NEMATOLOGY	J PHYS F	JOURNAL OF PHYSICS PART F METAL PHYSICS
J NERV MENT	JOURNAL OF NERVOUS AND MENTAL DISEASE	J PHYS JAP	JOURNAL OF THE PHYSICAL SOCIETY OF JAPAN AND SUPPLEMENT
J NEUR SCI	JOURNAL OF THE NEUROLOGICAL SCIENCES	J PHYS LETT	JOURNAL DE PHYSIQUE LETTRES
J NEURAL TR	JOURNAL OF NEURAL TRANSMISSION	J PHYS OCEA	JOURNAL OF PHYSICAL OCEANOGRAPHY
J NEUROBIOL	JOURNAL OF NEUROBIOLOGY	J PHYSIQUE	JOURNAL DE PHYSIQUE
J NEUROCHEM	JOURNAL OF NEUROCHEMISTRY	J PHYSIOL LON	JOURNAL OF PHYSIOLOGY LONDON
J NEUROCYT	JOURNAL OF NEUROCYTOLOGY	J PHYSIOL PAR	JOURNAL DE PHYSIOLOGIE PARIS
J NEUROL	JOURNAL OF NEUROLOGY ZEITSCHRIFT FUR NEUROLOGIE	J PLASMA PH	JOURNAL OF PLASMA PHYSICS
J NEUROSURG	JOURNAL OF NEUROSURGERY	J POL SC PC	JOURNAL OF POLYMER SCIENCE POLYMER CHEMISTRY EDITION
J NEURPHYSL	JOURNAL OF NEUROPHYSIOLOGY	J POL SC PL	JOURNAL OF POLYMER SCIENCE POLYMER LETTERS EDITION
J NON-CRYST	JOURNAL OF NON-CRYSTALLINE SOLIDS	J POL SC PP	JOURNAL OF POLYMER SCIENCE POLYMER PHYSICS EDITION
J NUC SCI T	JOURNAL OF NUCLEAR SCIENCE AND TECHNOLOGY TOKYO	J POL SCI C	JOURNAL OF POLYMER SCIENCE PART C POLYMER SYMPOSIA
J NUCL BIOL	JOURNAL OF NUCLEAR BIOLOGY AND MEDICINE	J POWER-ASC	JOURNAL OF THE POWER DIVISION-ASCE
J NUCL MAT	JOURNAL OF NUCLEAR MATERIALS	J PRAK CHEM	JOURNAL FUR PRAKTISCHE CHEMIE
J NUCL MED	JOURNAL OF NUCLEAR MEDICINE	J PRE CONCR	JOURNAL OF THE PRESTRESSED CONCRETE INSTITUTE
J NUTR	JOURNAL OF NUTRITION AND SUPPLEMENT	J PROS DENT	JOURNAL OF PROSTHETIC DENTISTRY
J NUTR SC V	JOURNAL OF NUTRITIONAL SCIENCE AND VITAMINOLOGY	J PROTOZOO	JOURNAL OF PROTOZOLOGY
J NY ENT SO	JOURNAL OF THE NEW YORK ENTOMOLOGICAL SOCIETY	J PSYCH RES	JOURNAL OF PSYCHIATRIC RESEARCH
J OBSTET GY	JOURNAL OF OBSTETRICS AND GYNAECOLOGY OF THE BRITISH COMMONWEALTH	J PSYCHOL	JOURNAL OF PSYCHOLOGY
J OIL COL C	JOURNAL OF THE OIL AND COLOUR CHEMISTS ASSOCIATION	J PSYCHOSOM	JOURNAL OF PSYCHOSOMATIC RESEARCH
J OP RES SO	JOURNAL OF THE OPERATIONS RESEARCH SOCIETY OF JAPAN	J QUAN SPEC	JOURNAL OF QUANTITATIVE SPECTROSCOPY AND RADIATIVE TRANSFER
J OPT SOC	JOURNAL OF THE OPTICAL SOCIETY OF AMERICA	J RAD CHEM	JOURNAL OF RADIOANALYTICAL CHEMISTRY
J ORAL SURG	JOURNAL OF ORAL SURGERY	J RAD RES L	JOURNAL OF THE RADIO RESEARCH LABORATORIES
J ORG CHEM	JOURNAL OF ORGANIC CHEMISTRY		
J ORGMET CH	JOURNAL OF ORGANOMETALLIC CHEMISTRY		

ISI ABBREVIATION	FULL TITLE
J RADIOL	JOURNAL DE RADIOLOGIE D ELECTROLOGIE ET DE MEDECINE NUCLEAIRE
J RANGE MAN	JOURNAL OF RANGE MANAGEMENT
J REIN MATH	JOURNAL FUR DIE REINE UND ANGEWANDTE MATHEMATIK
J REPR FERT	JOURNAL OF REPRODUCTION AND FERTILITY
J REPRO MED	JOURNAL OF REPRODUCTIVE MEDICINE
J RES NBS A	JOURNAL OF RESEARCH OF THE NATIONAL BUREAU OF STANDARDS. SECTION A PHYSICS AND CHEMISTRY
J RES NBS B	JOURNAL OF RESEARCH OF THE NATIONAL BUREAU OF STANDARDS. SECTION B MATHEMATICAL SCIENCES
J RETIC SOC	JOURNAL OF THE RETICULOENDOTHELIAL SOCIETY
J RHEUMATOL	JOURNAL OF RHEUMATOLOGY
J ROY AGR S	JOURNAL OF THE ROYAL AGRICULTURAL SOCIETY OF ENGLAND
J ROY ASTRO	JOURNAL OF THE ROYAL ASTRONOMICAL SOCIETY OF CANADA
J ROY STA A	JOURNAL OF THE ROYAL STATISTICAL SOCIETY. SERIES A GENERAL
J ROY STA B	JOURNAL OF THE ROYAL STATISTICAL SOCIETY. SERIES B METHODOLOGICAL
J ROY STA C	JOURNAL OF THE ROYAL STATISTICAL SOCIETY. SERIES C APPLIED STATISTICS
J RS NZ	JOURNAL OF THE ROYAL SOCIETY OF NEW ZEALAND
J S COSM CH	JOURNAL OF THE SOCIETY OF COSMETIC CHEMISTS
J S DYE COL	JOURNAL OF THE SOCIETY OF DYERS AND COLOURISTS
J SA CHEM I	JOURNAL OF THE SOUTH AFRICAN CHEMICAL INSTITUTE
J SA I MIN	JOURNAL OF THE SOUTH AFRICAN INSTITUTE OF MINING AND METALLURGY
J SCI FOOD	JOURNAL OF THE SCIENCE OF FOOD AND AGRICULTURE
J SCI IND R	JOURNAL OF SCIENTIFIC AND INDUSTRIAL RESEARCH
J SCI LAB D	JOURNAL OF THE SCIENTIFIC LABORATORIES DENISON UNIVERSITY
J SCI TECH	JOURNAL OF SCIENCE AND TECHNOLOGY
J SED PETRO	JOURNAL OF SEDIMENTARY PETROLOGY
J SM ANIM P	JOURNAL OF SMALL ANIMAL PRACTICE
J SMPTE	JOURNAL OF THE SOCIETY OF MOTION PICTURE TELEVISION ENGINEERS
J SOC PSYCH	JOURNAL OF SOCIAL PSYCHOLOGY
J SOIL SCI	JOURNAL OF SOIL SCIENCE
J SOIL WAT	JOURNAL OF SOIL AND WATER CONSERVATION
J SOL ST CH	JOURNAL OF SOLID STATE CHEMISTRY
J SOUND VIB	JOURNAL OF SOUND AND VIBRATION
J SPAC ROCK	JOURNAL OF SPACECRAFT AND ROCKETS
J SPEECH HE	JOURNAL OF SPEECH AND HEARING RESEARCH
J STAT PHYS	JOURNAL OF STATISTICAL PHYSICS
J STERIOD B	JOURNAL OF STERIOD BIOCHEMISTRY
J STORED PR	JOURNAL OF STORED PRODUCTS RESEARCH
J STRUC MEC	JOURNAL OF STRUCTURAL MECHANICS
J STRUCT DI	JOURNAL OF THE STRUCTURAL DIVISION-ASCE
J SUBMIC CY	JOURNAL OF SUBMICROSCOPIC CYTOLOGY
J SURG RES	JOURNAL OF SURGICAL RESEARCH
J SURV MAPP	JOURNAL OF THE SURVEYING AND MAPPING DIVISION-ASCE
J SYMB LOG	JOURNAL OF SYMBOLIC LOGIC
J SYN ORG J	JOURNAL OF SYNTHETIC ORGANIC CHEMISTRY. JAPAN
J TEST EVAL	JOURNAL OF TESTING AND EVALUATION

ISI ABBREVIATION	FULL TITLE
J TEXTILE I	JOURNAL OF THE TEXTILE INSTITUTE
J THEOR BIO	JOURNAL OF THEORETICAL BIOLOGY
J THERM ANA	JOURNAL OF THERMAL ANALYSIS
J THOR SURG	JOURNAL OF THORACIC AND CARDIOVASCULAR SURGERY
J TRAUMA	JOURNAL OF TRAUMA
J TROP MED	JOURNAL OF TROPICAL MEDICINE AND HYGIENE
J ULTRA RES	JOURNAL OF ULTRASTRUCTURE RESEARCH
J URÖL	JOURNAL OF UROLOGY
J UROL NEPH	JOURNAL D UROLOGIE ET DE NEPHROLOGIE
J VAC SCI T	JOURNAL OF VACUUM SCIENCE AND TECHNOLOGY
J VERB LEAR	JOURNAL OF VERBAL LEARNING AND VERBAL BEHAVIOR
J VIROLOGY	JOURNAL OF VIROLOGY
J WATER P C	JOURNAL OF THE WATER POLLUTION CONTROL FEDERATION
J WATERWAY	JOURNAL OF THE WATERWAYS, HARBORS AND COASTAL ENGINEERING DIVISION-ASCE
J WILDL MAN	JOURNAL OF WILDLIFE MANAGEMENT
J ZOO	JOURNAL OF ZOOLOGY
JAP ANALYST	JAPAN ANALYST
JAP CIRC J	JAPANESE CIRCULATION JOURNAL. ENGLISH EDITION
JAP HEART J	JAPANESE HEART JOURNAL
JAP J A PHY	JAPANESE JOURNAL OF APPLIED PHYSICS
JAP J BOTAN	JAPANESE JOURNAL OF BOTANY
JAP J EXP M	JAPANESE JOURNAL OF EXPERIMENTAL MEDICINE
JAP J GENET	JAPANESE JOURNAL OF GENETICS
JAP J HUM G	JAPANESE JOURNAL OF HUMAN GENETICS
JAP J MED S	JAPANESE JOURNAL OF MEDICAL SCIENCE AND BIOLOGY
JAP J MICRO	JAPANESE JOURNAL OF MICROBIOLOGY
JAP J PHARM	JAPANESE JOURNAL OF PHARMACOLOGY
JAP J PHYSL	JAPANESE JOURNAL OF PHYSIOLOGY
JAP J VET R	JAPANESE JOURNAL OF VETERINARY RESEARCH
JAP J VET S	JAPANESE JOURNAL OF VETERINARY SCIENCE
JAP J ZOO	JAPANESE JOURNAL OF ZOOLOGY
JAP PSY RES	JAPANESE PSYCHOLOGICAL RESEARCH
JAP TELECOM	JAPAN TELECOMMUNICATIONS REVIEW
JERNKON ANN	JERNKONTORETS ANNALER
JETP LETTER	JETP LETTERS. USSR
JOHNS H MED	JOHNS HOPKINS MEDICAL JOURNAL
KAUT GUM KU	KAUTSCHUK UND GUMMI KUNSTSTOFFE
KEM KOZLEM	KEMAI KOZLEMENYEK
KEM TIDSKR	KEMISK TIDSKRIFT
KERNENERGIE	KERNENERGIE
KERNTECHNIK	KERNTECHNIK
KHIM FAR ZH	KHIMIKO FARMATSEVTICHESKII ZHURNAL
KHIM GETERO	KHIMIYA GETEROTSIKLICHESKIKH SOEDINENII
KHIM PRIR S	KHIMIYA PRIRODNYKH SOEDINENII
KIDNEY INT	KIDNEY INTERNATIONAL
KJEMI	KJEMI
KLIN MONATS	KLINISCHE MONATSBLATTER FUR AUGENHEILKUNDE
KLIN PADIAI	KLINISCHE PADIAITRIE
KLIN WOCH	KLINISCHE WOCHENSCHRIFT
KOBUNSH ROM	KOBUNSHI RONBUNSHU
KOLL ZH	KOLLOIDNYI ZHURNAL

ISI ABBREVIATION	FULL TITLE
KOSM B AV M	KOSMICHESKAYA BIOLOGIYA I AVIAKOSMICHESKAYA MEDITSINA
KRISTALLOGR	KRISTALLOGRAFIYA
KUNSTSTOFFE	KUNSTSTOFFE-PLASTICS
KYBERNETIK	KYBERNETIK
LAB ANIM SC	LABORATORY ANIMAL SCIENCE
LAB INV	LABORATORY INVESTIGATION
LANCET	LANCET
LANDBAU VOL	LANDBAUFORSCHUNG VOLKENRODE
LANDBOUWMEC	LANDBOUWMECHANISATIE
LANDTECHNIK	LANDTECHNIK
LANG SPEECH	LANGUAGE AND SPEECH
LANGENBECK	LANGENBECKS ARCHIV FUR CHIRURGIE
LARYNGOSCOPE	LARYNGOSCOPE
LEBENS M IND	LEBENS MITTEL INDUSTRIE
LEBER MAG D	LEBER MAGEN DARM
LETHAIA	LETHAIA
LETT NUOV C	LETTERE AL NUOVO CIMENTO
LIB RES TEC	LIBRARY RESOURCES AND TECHNICAL SERVICES
LIB TRENDS	LIBRARY TRENDS
LIBRARY J	LIBRARY JOURNAL
LIBRARY Q	LIBRARY QUARTERLY
LICHTTECH	LICHTTECHNIK
LIFE SCI	LIFE SCIENCES
LILLE MED	LILLE MEDICAL
LIMN OCEAN	LIMNOLOGY AND OCEANOGRAPHY
LIPIDS	LIPIDS
LLOYDIA	LLOYDIA
LUBRIC ENG	LUBRICATION ENGINEERING
LUBRICATION	LUBRICATION
LYMPHOLOGY	LYMPHOLOGY
LYON MED	LYON MEDICAL
LYON PHARM	LYON PHARMACEUTIQUE
M NOT R AST	MONTHLY NOTICES OF THE ROYAL ASTRONOMICAL SOCIETY
M WEATH REV	MONTHLY WEATHER REVIEW
MACH PROD E	MACHINERY AND PRODUCTION ENGINEERING
MACH TOOL R	MACHINE-TOOL REVIEW
MACHINE DES	MACHINE DESIGN
MACHINERY	MACHINERY
MACROMOL R	MACROMOLECULAR REVIEWS. PART D JOURNAL OF POLYMER SCIENCE
MACROMOLEC	MACROMOLECULES
MAG CONCR R	MAGAZINE OF CONCRETE RESEARCH
MAGY KEM FO	MAGYAR KEMIAI FOLYOIRAT
MAGY KEM LA	MAGYAR KEMIKUSOK LAPJA
MAKROM CHEM	MAKROMOLEKULARE CHEMIE
MANAG SCI A	MANAGEMENT SCIENCE SERIES A THEORY
MANUF CH AE	MANUFACTURING CHEMIST AND AEROSOL NEWS
MANUF ENG M	MANUFACTURING ENGINEERING & MANAGEMENT
MANUSC MATH	MANUSCRIPTA MATHEMATICA
MAR FISH RE	MARINE FISHERIES REVIEW
MAR TECH SJ	MARINE TECHNOLOGY SOCIETY JOURNAL
MARCONI REV	MARCONI REVIEW
MARINE BIOL	MARINE BIOLOGY
MARINE GEOL	MARINE GEOLOGY
MASCHIN TEC	MASCHINENBAU TECHNIK
MAT FYS MED	MATEMATISK-FYSISKE MEDDELELSER UDGIVET AF DET KONGELIGE DANSKE VIDENSKABERNES SELSKAB

ISI ABBREVIATION	FULL TITLE
MAT FYS SKR	MATEMATISK-FYSISKE SKRIFTER UDGIVET AF DET KONGELIGE DANSKE VIDENSKABERNES SELSKAB
MATER ENG	MATERIALS ENGINEERING
MATER EVAL	MATERIALS EVALUATION
MATER PERF	MATERIALS PERFORMANCE
MATER RES B	MATERIALS RESEARCH BULLETIN
MATER SCI E	MATERIALS SCIENCE AND ENGINEERING
MATH ANNAL	MATHEMATISCHE ANNALEN
MATH CDMPT	MATHEMATICS OF COMPUTATION
MATH NACHR	MATHEMATISCHE NACHRICHTEN
MATH SCAND	MATHEMATICA SCANDINAVICA
MATH Z	MATHEMATISCHE ZEITSCHRIFT
MATHEMATIKA	MATHEMATIKA
MATR TENS Q	MATRIX AND TENSOR QUARTERLY
MAYO CLIN P	MAYO CLINIC PROCEEDINGS
MEAS CONTRO	MEASUREMENT AND CONTROL
MEAS TECH R	MEASUREMENT TECHNIQUES. USSR
MECH AGE D	MECHANISMS OF AGEING AND DEVELOPMENT
MECH ENG	MECHANICAL ENGINEERING
MECH HANDL	MECHANICAL HANDLING
MECH MACH T	MECHANISM AND MACHINE THEORY
MECHANIK	MECHANIK MIESIECZNIK NAUKOW TECHNICZNY
MED BIO ENG	MEDICAL AND BIOLOGICAL ENGINEERING
MED BIO ILL	MEDICAL AND BIOLOGICAL ILLUSTRATION
MED BIOL	MEDICAL BIOLOGY
MED C VIRG	MEDICAL COLLEGE OF VIRGINIA QUARTERLY
MED CLIN NA	MEDICAL CLINICS OF NORTH AMERICA
MED J AUST	MEDICAL JOURNAL OF AUSTRALIA
MED LAB TEC	MEDICAL LABORATORY TECHNOLOGY
MED MICROBI	MEDICAL MICROBIOLOGY AND IMMUNOLOGY
MED RES ENG	MEDICAL RESEARCH ENGINEERING
MED SCI SPT	MEDICINE AND SCIENCE IN SPORTS
MEDD NOR SK	MEDDELELSER FRA DET NORSKE SKOGFORSOKSVESEN
MEDICINA	MEDICINA
MEDICINE	MEDICINE
MEM AM MATH	MEMOIRS OF THE AMERICAN MATHEMATICAL SOCIETY
MEM COGNIT	MEMORY AND COGNITION
MEM ENT S C	MEMOIRS OF THE ENTOMOLOGICAL SOCIETY OF CANADA
MEM I OSW C	MEMORIAS DO INSTITUTO OSWALDO CRUZ
MEM S R MET	MEMOIRES SCIENTIFIQUES DE LA REVUE DE METALLURGIE
MES REG AUT	MESURES REGULATION AUTOMATISME
MESSTECHNIK	MESSTECHNIK
MET INF MED	METHODS OF INFORMATION IN MEDICINE
METABOLISM	METABOLISM
METAL CONST	METAL CONSTRUCTION AND BRITISH WELDING JOURNAL
METAL ENG Q	METALS ENGINEERING QUARTERLY
METAL PROGR	METAL PROGRESS
METAL STAMP	METAL STAMPING
METAL TREAT	METAL TREATING
METALL	METALL
METALL ITAL	METALLURGIA ITALIANA
METALL MET	METALLURGIA AND METAL FORMING

ISI ABBREVIATION	FULL TITLE
METALLURG T	METALLURGICAL TRANSACTIONS
METEOR MAG	METEOROLOGICAL MAGAZINE
METEOR RUND	METEOROLOGISCHE RUNDschau
METROLOGIA	METROLOGIA
MICH MATH J	MICHIGAN MATHEMATICAL JOURNAL
MICROBIOS	MICROBIOS
MICROCHEM J	MICROCHEMICAL JOURNAL
MICROEL REL	MICROELECTRONICS AND RELIABILITY
MICROSCOPE	MICROSCOPE
MICROTECHN	MICROTECHNIC
MICROVASC R	MICROVASCULAR RESEARCH
MIKROBIOLOG	MIKROBIOLOGIJA
MIKROCH ACT	MIKROCHIMICA ACTA
MIKROSKOPIE	MIKROSKOPIE
MILIT MED	MILITARY MEDICINE
MIN CONGR J	MINING CONGRESS JOURNAL
MIN DEPOSIT	MINERALIUM DEPOSITA
MIN MET Q	MINING AND METALLURGY QUARTERLY
MIN RAD	MINERVA RADIOLOGICA
MINERAL MAG	MINERALOGICAL MAGAZINE
MITT B FORS	MITTEILUNGEN DER BUNDESFORSCHUNGSANSTALT FUR FORST- UND HOLZWIRTSCHAFT
MOD PLAST	MODERN PLASTICS
MOL BIOL R	MOLEKULYARNAYA BIOLOGIYA
MOL BIOL RP	MOLECULAR BIOLOGY REPORTS
MOL C BIOCH	MOLECULAR AND CELLULAR BIOCHEMISTRY
MOL C ENDOC	MOLECULAR AND CELLULAR ENDOCRINOLOGY
MOL G GENET	MOLECULAR AND GENERAL GENETICS
MOL PHOTOC	MOLECULAR PHOTOCHEMISTRY
MOLEC CRYST	MOLECULAR CRYSTALS AND LIQUID CRYSTALS
MOLEC PHARM	MOLECULAR PHARMACOLOGY
MOLEC PHYS	MOLECULAR PHYSICS
MON PAEDIAT	MONOGRAPHS IN PAEDIATRICS
MON S RES C	MONOGRAPHS OF THE SOCIETY FOR RESEARCH IN CHILD DEVELOPMENT
MONATS CHEM	MONATSHEFTE FUR CHEMIE
MONATS KIND	MONATSSCHRIFT FUR KINDERHEILKUNDE
MONATS MATH	MONATSHEFTE FUR MATHEMATIK
MONATS UNFA	MONATSSCHRIFT FUR UNFALLHEILKUNDE VERSICHERUNGS-, VERSORGUNGS- UND VERKEHRSMEDIZIN
MOSQUITO NE	MOSQUITO NEWS
MT SINAI J	MOUNT SINAI JOURNAL OF MEDICINE
MUTAT RES	MUTATION RESEARCH
MYCOLOGIA	MYCOLOGIA
MYCOP MYC A	MYCOPATHOLOGIA ET MYCOLOGIA APPLICATA AND SUPPLEMENTUM
N ENG J MED	NEW ENGLAND JOURNAL OF MEDICINE
N S ARCH PH	NAJUNY SCHMIELEBERGS ARCHIVES OF PHARMACOLOGY
NACHR DOKUM	NACHRICHTEN FUR DOKUMENTATION
NACHRTECH Z	NACHRICHTENTECHNISCHE ZEITSCHRIFT
NAG MATH J	NAGOYA MATHEMATICAL JOURNAL
NAT CAN I M	NATIONAL CANCER INSTITUTE MONOGRAPH
NAT I ANIM	NATIONAL INSTITUTE OF ANIMAL HEALTH QUARTERLY
NATURAL CAN	NATURALISTE CANADIEN
NATURAL HI	NATURAL HISTORY
NATURE	NATURE
NATURE-BIOL	NATURE-NEW BIOLOGY
NATURE-PHYS	NATURE-PHYSICAL SCIENCE
NATURWISSEN	NATURWISSENSCHAFTEN

ISI ABBREVIATION	FULL TITLE
NAU T INF 1	NAUCHNO-TEKHNICHESKAYA INFORMATSIYA SERIYA 1 ORGANIZATSIYA I METODIKA INFORMATSIONNOI RABOTY
NAU T INF 2	NAUCHNO-TEKHNICHESKAYA INFORMATSIYA SERIYA 2 INFORMATSIONNYE PROTSESSY I SISTEMY
NAV ENG J	NAVAL ENGINEERS JOURNAL
NAV RES LOG	NAVAL RESEARCH LOGISTICS QUARTERLY
NAV RES REV	NAVAL RESEARCH REVIEWS
NBS MONOGR	NATIONAL BUREAU OF STANDARDS MONOGRAPHS
NEC RES DEV	NEC RESEARCH AND DEVELOPMENT
NEMATOLOGIC	NEMATOLOGICA
NEOPLASMA	NEOPLASMA
NEPHRON	NEPHRON
NERVENARZT	NERVENARZT
NETH MILK D	NETHERLANDS MILK AND DAIRY JOURNAL NEDERLANDS MELK- EN ZUIVELTJDSCHRIFT
NEURO-CHIRE	NEURO-CHIRURGIE
NEUROBIOLOG	NEUROBIOLOGY
NEUROCHIRA	NEUROCHIRURGIA
NEUROENDOCR	NEUROENDOCRINOLOGY
NEUROLOGY	NEUROLOGY
NEUROPADIA T	NEUROPADIATRIE
NEUROPHARM	NEUROPHARMACOLOGY
NEUROPSYCHO	NEUROPSYCHOLOGIA
NEURORADIOL	NEURORADIOLOGY
NEW PHYTOL	NEW PHYTOLOGIST
NIP KAG KAI	NIPPON KAGAKU KAISHI
NON-DESTR T	NON-DESTRUCTIVE TESTING
NORD VETMED	NORDISK VETERINAER MEDICIN
NORSK SKOG	NORSK SKOGINDUSTRI
NOT AM MATH	NOTICES OF THE AMERICAN MATHEMATICAL SOCIETY
NOUV PRESSE	NOUVELLE PRESSE MEDICALE
NOUV R OPT	NOUVELLE REVUE D'OPTIQUE
NOUV RF HEM	NOUVELLE REVUE FRANCAISE D'HEMATOLOGIE
NUCL ACID R	NUCLEIC ACIDS RESEARCH
NUCL ENG DE	NUCLEAR ENGINEERING AND DESIGN
NUCL ENG IN	NUCLEAR ENGINEERING INTERNATIONAL
NUCL FUSION	NUCLEAR FUSION
NUCL INSTR	NUCLEAR INSTRUMENTS AND METHODS
NUCL MED	NUCLEAR-MEDICIN NUCLEAR MEDICINE MEDECINE NUCLEAIRE
NUCL PHYS A	NUCLEAR PHYSICS A
NUCL PHYS B	NUCLEAR PHYSICS B
NUCL SAFETY	NUCLEAR SAFETY
NUCL SCI EN	NUCLEAR SCIENCE AND ENGINEERING
NUCL TECH	NUCLEAR TECHNOLOGY
NUCLEUS	NUCLEUS
NUMER MATH	NUMERISCHE MATHEMATIK
NUOV CIM A	NUOVO CIMENTO DELLA SOCIETA ITALIANA DI FISICA A
NUOV CIM B	NUOVO CIMENTO DELLA SOCIETA ITALIANA DI FISICA B
NUTR METAB	NUTRITION AND METABOLISM
NUTR REP IN	NUTRITION REPORTS INTERNATIONAL
NUTR REV	NUTRITION REVIEWS
NY ST J MED	NEW YORK STATE JOURNAL OF MEDICINE
NZ J AGR	NEW ZEALAND JOURNAL OF AGRICULTURE
NZ J AGR RE	NEW ZEALAND JOURNAL OF AGRICULTURAL RESEARCH
NZ J GEOL	NEW ZEALAND JOURNAL OF GEOLOGY AND GEOPHYSICS
NZ J SCI	NEW ZEALAND JOURNAL OF SCIENCE

ISI ABBREVIATION	FULL TITLE
NZ MED J	NEW ZEALAND MEDICAL JOURNAL
OBSERVATORY	OBSERVATORY
OBSTET GYN	OBSTETRICS AND GYNECOLOGY
OCEAN ENG	OCEAN ENGINEERING
OCEANOLOG R	OCEANOLOGY USSR
OCEANS	OCEANS
OECO PLANTA	OECOLOGIA PLANTARUM
OECOLOGIA	OECOLOGIA
OIKOS	OIKOS
OMR ORG MAG	OMR ORGANIC MAGNETIC RESONANCE
ONCOLOGY	ONCOLOGY
OPERAT R Q	OPERATIONAL RESEARCH QUARTERLY
OPERAT RES	OPERATIONS RESEARCH
OPHTHAL RES	OPHTHALMIC RESEARCH
OPHTHALMOLA	OPHTHALMOLOGICA
OPT COMMUN	OPTICS COMMUNICATIONS
OPT ENG	OPTICAL ENGINEERING
OPT SPEKTRO	OPTIKA SPEKTROSKOPINA
OPTICA ACTA	OPTICA ACTA
OPTIK	OPTIK
OPTO-ELECTR	OPTOELECTRONICS
ORAL SURG O	ORAL SURGERY ORAL MEDICINE AND ORAL PATHOLOGY
ORG MASS SP	ORGANIC MASS SPECTROMETRY
ORIGIN LIFE	ORIGINS OF LIFE
ORL J OTO R	ORL JOURNAL FOR OTO-RHINO-LARYNGOLOGY & ITS BORDERLANDS
OSTER BOT Z	OSTERREICHISCHE BOTANISCHE ZEITSCHRIFT
OXID METAL	OXIDATION OF METALS
P AC NAT S	PROCEEDINGS OF THE ACADEMY OF NATURAL SCIENCES OF PHILADELPHIA
P AM ASS CA	PROCEEDINGS OF THE AMERICAN ASSOCIATION FOR CANCER RESEARCH
P AM MATH S	PROCEEDINGS OF THE AMERICAN MATHEMATICAL SOCIETY
P AUST BIOC	PROCEEDINGS OF THE AUSTRALIAN BIOCHEMICAL SOCIETY
P CAMB PHIL	PROCEEDINGS OF THE CAMBRIDGE PHILOSOPHICAL SOCIETY MATHEMATICAL AND PHYSICAL SCIENCES
P EDIN MATH	PROCEEDINGS OF THE EDINBURGH MATHEMATICAL SOCIETY
P ENT S ONT	PROCEEDINGS OF THE ENTOMOLOGICAL SOCIETY OF ONTARIO
P ENT S WAS	PROCEEDINGS OF THE ENTOMOLOGICAL SOCIETY OF WASHINGTON
P GEOL AS C	PROCEEDINGS OF THE GEOLOGICAL ASSOCIATION OF CANADA
P HAWAII EN	PROCEEDINGS OF THE HAWAIIAN ENTOMOLOGICAL SOCIETY
P HELM SOC	PROCEEDINGS OF THE HELMINTHOLOGICAL SOCIETY OF WASHINGTON
P I A SCI A	PROCEEDINGS OF THE INDIAN ACADEMY OF SCIENCES SECTION A
P I A SCI B	PROCEEDINGS OF THE INDIAN ACADEMY OF SCIENCES SECTION B
P I CIV E 1	PROCEEDINGS OF THE INSTITUTION OF CIVIL ENGINEERS PART 1 DESIGN AND CONSTRUCTION
P I CIV E 2	PROCEEDINGS OF THE INSTITUTION OF CIVIL ENGINEERS PART 2 RESEARCH AND THEORY
P I CIV ENG	PROCEEDINGS OF THE INSTITUTION OF CIVIL ENGINEERS
P IEE LOND	PROCEEDINGS OF THE INSTITUTION OF ELECTRICAL ENGINEERS, LONDON
P IEEE	PROCEEDINGS OF THE INSTITUTE OF ELECTRICAL AND ELECTRONICS ENGINEERS
P JAP ACAD	PROCEEDINGS OF THE JAPAN ACADEMY

ISI ABBREVIATION	FULL TITLE
P KON NED A	PROCEEDINGS OF THE KONINKLIJKE NEDERLANDSE AKADEMIE VAN WETENSCHAPPEN SERIES A MATHEMATICAL SCIENCES
P KON NED B	PROCEEDINGS OF THE KONINKLIJKE NEDERLANDSE AKADEMIE VAN WETENSCHAPPEN SERIES B PHYSICAL SCIENCES
P KON NED C	PROCEEDINGS OF THE KONINKLIJKE NEDERLANDSE AKADEMIE VAN WETENSCHAPPEN SERIES C BIOLOGICAL AND MEDICAL SCIENCES
P LEUC CULT	PROCEEDINGS OF THE SEVENTH LEUCOCYTE CULTURE CONFERENCE
P LOND MATH	PROCEEDINGS OF THE LONDON MATHEMATICAL SOCIETY
P NAS IND A	PROCEEDINGS OF THE NATIONAL ACADEMY OF SCIENCES, INDIA SECTION A PHYSICAL SCIENCES
P NAS IND B	PROCEEDINGS OF THE NATIONAL ACADEMY OF SCIENCES, INDIA SECTION B BIOLOGICAL SCIENCES
P NAS US	PROCEEDINGS OF THE NATIONAL ACADEMY OF SCIENCES OF THE UNITED STATES OF AMERICA
P NUTR SOC	PROCEEDINGS OF THE NUTRITION SOCIETY
P R IR AC A	PROCEEDINGS OF THE ROYAL IRISH ACADEMY SECTION A MATHEMATICAL, ASTRONOMICAL AND PHYSICAL SCIENCE
P R IR AC B	PROCEEDINGS OF THE ROYAL IRISH ACADEMY SECTION B BIOLOGICAL GEOLOGICAL AND CHEMICAL SCIENCE
P ROY S MED	PROCEEDINGS OF THE ROYAL SOCIETY OF MEDICINE
P ROY SOC A	PROCEEDINGS OF THE ROYAL SOCIETY LONDON SERIES A MATHEMATICAL AND PHYSICAL SCIENCES
P ROY SOC B	PROCEEDINGS OF THE ROYAL SOCIETY SERIES B BIOLOGICAL SCIENCES
P RS EDIN A	PROCEEDINGS OF THE ROYAL SOCIETY OF EDINBURGH SECTION A MATHEMATICAL AND PHYSICAL SCIENCES
P RS EDIN B	PROCEEDINGS OF THE ROYAL SOCIETY OF EDINBURGH SECTION B BIOLOGY
P SOC EXP M	PROCEEDINGS OF THE SOCIETY FOR EXPERIMENTAL BIOLOGY AND MEDICINE
P U OTAGO M	PROCEEDINGS OF THE UNIVERSITY OF OTAGO MEDICAL SCHOOL
P WEST PH S	PROCEEDINGS OF THE WESTERN PHARMACOLOGY SOCIETY
PAC INSECTS	PACIFIC INSECTS
PAC J MATH	PACIFIC JOURNAL OF MATHEMATICS
PAC-SCI	PACIFIC SCIENCE
PADIATR PAD	PADIATRIE UND PADOLOGIE
PALAEOGEO P	PALAEOGEOGRAPHY PALAEOCLIMATOLOGY PALAEOECOLOGY
PAN PAC ENT	PAN-PACIFIC ENTOMOLOGIST
PAP MET GEO	PAPERS IN METEOROLOGY AND GEOPHYSICS
PAP PUU	PAPERI JA PUU PAPPER OCH TRA
PAP TECHNOL	PAPER TECHNOLOGY
PAPIER	PAPIER
PARASITOL	PARASITOLOGY
PATH BIOL	PATHOLOGIE ET BIOLOGIE
PATH EUROP	PATHOLOGIA EUROPAEA
PATH MICROB	PATHOLOGIA ET MICROBIOLOGIA AND SUPPLEMENTUM
PATHOLOGY	PATHOLOGY
PATOL-MEX	PATOLOGIA MEXICO CITY
PATT RECOG	PATTERN RECOGNITION
PED CLIN NA	PEDIATRIC CLINICS OF NORTH AMERICA
PEDIAT RES	PEDIATRIC RESEARCH
PEDIATRICS	PEDIATRICS
PEDOBIOLOG	PEDOBIOLOGIA

ISI ABBREVIATION	FULL TITLE
PER BIOL	PERIODICUM BIOLOGORUM
PER POLY CE	PERIODICA POLYTECHNICA CHEMICAL ENGINEERING
PER POLY EE	PERIODICA POLYTECHNICA ELECTRICAL ENGINEERING
PER POLY ME	PERIODICA POLYTECHNICA MECHANICAL ENGINEERING
PERC MOT SK	PERCEPTUAL AND MOTOR SKILLS
PERC PSYCH	PERCEPTION AND PSYCHOPHYSICS
PERS PSYCH	PERSONNEL PSYCHOLOGY
PERSP BIOL	PERSPECTIVES IN BIOLOGY AND MEDICINE
PEST BIOCH	PESTICIDE BIOCHEMISTRY AND PHYSIOLOGY
PEST CONTRO	PEST CONTROL
PEST MON J	PESTICIDES MONITORING JOURNAL
PEST SCI	PESTICIDE SCIENCE
PFLUG ARCH	PFLUGERS ARCHIV EUROPEAN JOURNAL OF PHYSIOLOGY
PHARM ACT H	PHARMACEUTICA ACTA HELVETIAE
PHARM BIO B	PHARMACOLOGY BIOCHEMISTRY AND BEHAVIOR
PHARM PRAX	PHARMAZEUTISCHE PRAXIS, BEILAGE ZUR ZEITSCHRIFT DIE PHARMAZIE
PHARM REV	PHARMACOLOGICAL REVIEWS
PHARMACOL	PHARMACOLOGY
PHARMACOL R	PHARMACOLOGICAL RESEARCH COMMUNICATIONS
PHARMACOLOG	PHARMACOLOGIST
PHARMAKOPSY	PHARMAKOPSYCHIATRIE NEUROPSYCHOPHARMAKOLOGIE
PHARMAZIE	PHARMAZIE
PHI T ROY A	PHILOSOPHICAL TRANSACTIONS OF THE ROYAL SOCIETY OF LONDON SERIES A MATHEMATICAL AND PHYSICAL SCIENCES
PHI T ROY B	PHILOSOPHICAL TRANSACTIONS OF THE ROYAL SOCIETY OF LONDON SERIES B BIOLOGICAL SCIENCES
PHIL RES R	PHILIPS RESEARCH REPORTS AND SUPPLEMENT
PHIL TECH R	PHILIPS TECHNICAL REVIEW
PHILOS MAG	PHILOSOPHICAL MAGAZINE
PHILOS SCI	PHILOSOPHY OF SCIENCE
PHONETICA	PHONETICA
PHOT SCI EN	PHOTOGRAPHIC SCIENCE AND ENGINEERING
PHOTOCHEM P	PHOTOCHEMISTRY AND PHOTOBIOLOGY
PHOTOGR ENG	PHOTOGRAMMETRIC ENGINEERING
PHOTOGRAMMA	PHOTOGRAMMETRIA
PHOTOSYNTH	PHOTOSYNTHECA
PHYS C GLAS	PHYSICS AND CHEMISTRY OF GLASSES
PHYS COND M	PHYSICS OF CONDENSED MATTER
PHYS FLUIDS	PHYSICS OF FLUIDS
PHYS LETT A	PHYSICS LETTERS
PHYS LETT B	PHYSICS LETTERS
PHYS MED BI	PHYSICS IN MEDICINE AND BIOLOGY
PHYS NORVEG	PHYSICA NORVEGICA
PHYS REV A	PHYSICAL REVIEW A GENERAL PHYSICS
PHYS REV B	PHYSICAL REVIEW B SOLID STATE
PHYS REV C	PHYSICAL REVIEW C NUCLEAR PHYSICS
PHYS REV D	PHYSICAL REVIEW D PARTICLES AND FIELDS
PHYS REV L	PHYSICAL REVIEW LETTERS
PHYS SCR	PHYSICA SCRIPTA
PHYS ST S-A	PHYSICA STATUS SOLIDI A APPLIED RESEARCH
PHYS ST S-B	PHYSICA STATUS SOLIDI B BASIC RESEARCH
PHYS TODAY	PHYSICS TODAY
PHYSICA	PHYSICA

ISI ABBREVIATION	FULL TITLE
PHYSIOL REV	PHYSIOLOGICAL REVIEWS
PHYSL BEHAV	PHYSIOLOGY AND BEHAVIOR
PHYSL BOHEM	PHYSIOLOGIA BOHEMOSLOVACA
PHYSL CHEM	PHYSIOLOGICAL CHEMISTRY AND PHYSICS
PHYSL PL P	PHYSIOLOGICAL PLANT PATHOLOGY
PHYSL PLANT	PHYSIOLOGIA PLANTARUM
PHYSL PSYCH	PHYSIOLOGICAL PSYCHOLOGY
PHYSL VEGET	PHYSIOLOGIE VEGETALE
PHYSL ZOO	PHYSIOLOGICAL ZOOLOGY
PHYTOCHEM	PHYTOCHEMISTRY
PHYTOMA	PHYTOMA
PHYTOMORPH	PHYTOMORPHOLOGY
PHYTON	PHYTON
PHYTON AUST	PHYTON ANNALES REI BOTANICAE
PHYTOPATHOL	PHYTOPATHOLOGY
PIPE GAS J	PIPELINE AND GAS JOURNAL
PLANET SPAC	PLANETARY AND SPACE SCIENCE
PLANT CEL P	PLANT AND CELL PHYSIOLOGY
PLANT DIS R	PLANT DISEASE REPORTER
PLANT PATH	PLANT PATHOLOGY
PLANT PHYSL	PLANT PHYSIOLOGY
PLANT SCI L	PLANT SCIENCE LETTERS
PLANT SOIL	PLANT AND SOIL
PLANTA	PLANTA
PLANTA MED	PLANTA MEDICA
PLAS R SURG	PLASTIC AND RECONSTRUCTIVE SURGERY
PLASMA PHYS	PLASMA PHYSICS
PLAST POLYM	PLASTICS AND POLYMERS
PLAST WORLD	PLASTICS WORLD
PLASTICA	PLASTICA
PNEUMONOL P	PNEUMONOLOGIE PNEUMONOLOGY
POL J PHAR	POLISH JOURNAL OF PHARMACOLOGY AND PHARMACY
POL REV RAD	POLISH REVIEW OF RADIOLOGY AND NUCLEAR MEDICINE
POLYM ENG S	POLYMER ENGINEERING AND SCIENCE
POLYM J	POLYMER JOURNAL
POLYM PLAST	POLYMER-PLASTICS TECHNOLOGY AND ENGINEERING
POLYMER	POLYMER
POST BIOCH	POSTEPI BIOCHEMII
POST O EE J	POST OFFICE ELECTRICAL ENGINEERS JOURNAL
POSTG MED J	POSTGRADUATE MEDICAL JOURNAL
POSTGR MED	POSTGRADUATE MEDICINE
POULTRY SCI	POULTRY SCIENCE
POWD METALL	POWDER METALLURGY
POWD TECH	POWDER TECHNOLOGY
POWER ENG	POWER ENGINEERING
PRACTITION	PRACTITIONER
PREP BIOCH	PREPARATIVE BIOCHEMISTRY
PRIB TEKHN	PRIBORY I TEKHNIKA I NSPERIMENTA
PRIKL MAT	PRIKLADNAYA MATEMATIKA I MEKHANIKA
PRIMATOLOG	PRIMATOLOGIA
PROCESS BIO	PROCESS BIOCHEMISTRY
PROCESS ENG	PROCESS ENGINEERING
PROG ALLERG	PROGRESS IN ALLERGY
PROG EX TUM	PROGRESS IN EXPERIMENTAL TUMOR RESEARCH
PROG FISH-C	PROGRESSIVE FISH CULTURIST
PROG MAT SC	PROGRESS IN MATERIALS SCIENCE
PROG MED GE	PROGRESS IN MEDICAL GENETICS

ISI ABBREVIATION	FULL TITLE
PROG MED VI	PROGRESS IN MEDICAL VIROLOGY
PROG SURG	PROGRESS IN SURGERY
PROG T PHYS	PROGRESS OF THEORETICAL PHYSICS
PRDSTAGLAND	PROSTAGLANDINS
PROTOPLASMA	PROTOPLASMA
PRZEMYSL CHEM	PRZEMYSL CHEMICZNY
PSYCH PRAX	PSYCHOLOGISCHE PRAXIS
PSYCHIAT CL	PSYCHIATRIA CLINICA
PSYCHIAT NE	PSYCHIATRIA NEUROLOGIA NEUROCHIRURGIA
PSYCHIAT Q	PSYCHIATRIC QUARTERLY
PSYCHIATRY	PSYCHIATRY
PSYCHOAN RE	PSYCHOANALYTIC REVIEW
PSYCHOL AFR	PSYCHOLOGIA AFRICANA
PSYCHOL B	PSYCHOLOGICAL BULLETIN
PSYCHOL ISS	PSYCHOLOGICAL ISSUES
PSYCHOL MED	PSYCHOLOGICAL MEDICINE
PSYCHOL REC	PSYCHOLOGICAL RECORD
PSYCHOL REP	PSYCHOLOGICAL REPORTS
PSYCHOL RES	PSYCHOLOGICAL RESEARCH
PSYCHOL REV	PSYCHOLOGICAL REVIEW
PSYCHOL STU	PSYCHOLOGICAL STUDIES
PSYCHOL TOD	PSYCHOLOGY TODAY
PSYCHOMETRI	PSYCHOMETRIKA AND SUPPLEMENTS
PSYCHOPHARM	PSYCHOPHARMACOLOGIA
PSYCHOPHYSL	PSYCHOPHYSIOLOGY
PSYCHOS MED	PSYCHOSOMATIC MEDICINE
PSYCHOSOMAT	PSYCHOSOMATICS
PSYCHOTH PS	PSYCHOTHERAPY AND PSYCHOSOMATICS
PUB AST S J	PUBLICATIONS OF THE ASTRONOMICAL SOCIETY OF JAPAN
PUB AST S P	PUBLICATIONS OF THE ASTRONOMICAL SOCIETY OF THE PACIFIC
PUB DOM AST	PUBLICATIONS OF THE DOMINION ASTROPHYSICAL OBSERVATORY VICTORIA B.C.
PUBL HEA RE	PUBLIC HEALTH REPORTS
PUBL HEAL	PUBLIC HEALTH THE JOURNAL OF THE SOCIETY OF MEDICAL OFFICERS OF HEALTH
PUBL OPIN Q	PUBLIC OPINION QUARTERLY
PUBL ROADS	PUBLIC ROADS
PULP PAPER	PULP AND PAPER MAGAZINE OF CANADA
PUMPS	PUMPS AND THEIR APPLICATIONS
PUR A CHEM	PURE AND APPLIED CHEMISTRY
PUR A GEOPH	PURE AND APPLIED GEOPHYSICS
Q APPL MATH	QUARTERLY OF APPLIED MATHEMATICS
Q J EXP PHY	QUARTERLY JOURNAL OF EXPERIMENTAL PHYSIOLOGY AND COGNATE MEDICAL SCIENCES
Q J EXP PSY	QUARTERLY JOURNAL OF EXPERIMENTAL PSYCHOLOGY
Q J MATH	QUARTERLY JOURNAL OF MATHEMATICS
Q J MECH AP	QUARTERLY JOURNAL OF MECHANICS AND APPLIED MATHEMATICS
Q J MED	QUARTERLY JOURNAL OF MEDICINE
Q J R ASTRO	QUARTERLY JOURNAL OF THE ROYAL ASTRONOMICAL SOCIETY
Q J R METED	QUARTERLY JOURNAL OF THE ROYAL METEOROLOGICAL SOCIETY
Q J STUD AL	QUARTERLY JOURNAL OF STUDIES ON ALCOHOL
Q REV BIOL	QUARTERLY REVIEW OF BIOLOGY
Q REV BIOPH	QUARTERLY REVIEW OF BIOPHICS
QUAL PLANT	QUALITAS PLANTARUM-PLANT FOODS FOR HUMAN NUTRITION
QUATERN RES	QUATERNARY RESEARCH
RAD CLIN	RADIOLOGIA CLINICA ET BIOLOGICA

ISI ABBREVIATION	FULL TITLE
RAD CLIN NA	RADIOLOGIC CLINICS OF NORTH AMERICA
RAD DIAGN	RADIOLOGIA DIAGNOSTICA
RAD RES REV	RADIATION RESEARCH REVIEWS
RADIAT BOT	RADIATION BOTANY
RADIAT DATA	RADIATION DATA AND REPORTS
RADIAT EFF	RADIATION EFFECTS
RADIAT ENV	RADIATION AND ENVIRONMENTAL BIOPHYSICS
RADIAT RES	RADIATION RESEARCH
RADIO EL EN	RADIO AND ELECTRONIC ENGINEER
RADIO SCI	RADIO SCIENCE
RADIOCARBON	RADIOCARBON
RADIOCH ACT	RADIOCHIMICA ACTA
RADIOLOGE	RADIOLOGE
RADIOLOGY	RADIOLOGY
RADIOTEK EL	RADIOTEKHNIKA I ELEKTRONIKA
RCA REVIEW	RCA REVIEW
REC TR CHIM	RECUEIL DES TRAVAUX CHIMIQUES DES PAYS-BAS
RECH AEROSP	RECHERCHE AEROSPATIALE
RECHERCHE	RECHERCHE
RECLAM ERA	RECLAMATION ERA
RECONS SURG	RECONSTRUCTION SURGERY AND TRAUMATOLOGY
REFRACTOR J	REFRACTORIES JOURNAL
REFRIG AIR	REFRIGERATION AND AIR CONDITIONING
REND GASTRO	RENDICONTI DI GASTRO-ENTEROLOGIA
REP IOM SPA	REPORT OF IONOSPHERE AND SPACE RESEARCH IN JAPAN
REP NRL PRO	REPORT OF NRL PROGRESS
REP PR PHYS	REPORTS ON PROGRESS IN PHYSICS
REPRODUCCIO	REPRODUCCION
RES COMM CP	RESEARCH COMMUNICATIONS IN CHEMICAL PATHOLOGY AND PHARMACOLOGY
RES DEVELOP	RESEARCH DEVELOPMENT
RES EXP MED	RESEARCH IN EXPERIMENTAL MEDICINE
RES MANAG	RESEARCH MANAGEMENT
RES VET SCI	RESEARCH IN VETERINARY SCIENCE
RESP PHYSL	RESPIRATION PHYSIOLOGY
RESPIRATION	RESPIRATION
REV CAN BIO	REVUE CANADIENNE DE BIOLOGIE
REV CHIM MI	REVUE DE CHIMIE MINERALE
REV CHIR OR	REVUE DE CHIRURGIE ORTHOPEDIQUE ET REPARATRICE DE L' APPAREIL MOTEUR
REV ECOL BS	REVUE D'ECOLOGIE ET DE BIOLOGIE DU SOL
REV EL COMM	REVIEW OF THE ELECTRICAL COMMUNICATION LABORATORY
REV EPIDEM	REVUE D'EPIDEMIOLOGIE MEDICINE SOCIALE ET SANTE PUBLIQUE
REV ESP FIS	REVISTA ESPANOLA DE FISIOLOGIA
REV F GY OB	REVUE FRANCAISE DE GYNECOLOGIE ET D'OBSTETRIQUE
REV FR ALLE	REVUE FRANCAISE D'ALLERGOLOGIE
REV FR AUTO	REVUE FRANCAISE D'AUTOMATIQUE INFORMATIQUE RECHERCHE OPERATIONNELLE
REV FR TRAN	REVUE FRANCAISE DE TRANSFUSION
REV G THERM	REVUE GENERALE DE THERMIQUE
REV GEOPH	REVUE DE GEOGRAPHIE PHYSIQUE ET DE GEOLOGIE DYNAMIQUE
REV GEOPHYS	REVIEWS OF GEOPHYSICS AND SPACE PHYSICS
REV I F PET	REVUE DE L'INSTITUT FRANCAIS DU PETROLE ET ANNALES DES COMBUSTIBLES LIQUIDES
REV IN HAUT	REVUE INTERNATIONALE DES HAUTES TEMPERATURES ET DES REFRACTAIRES

ISI ABBREVIATION	FULL TITLE
REV INF MED	REVUE D'INFORMATIQUE MEDICALE
REV INV CLI	REVISTA DE INVESTIGACION CLINICA
REV M PHYS	REVIEWS OF MODERN PHYSICS
REV MED CHI	REVISTA MEDICA DE CHILE
REV METALL	REVUE DE METALLURGIE
REV MICR EL	REVISTA DE MICROSCOPIA ELECTRONICA
REV NEUROL	REVUE NEUROLOGIQUE
REV PALAE P	REVIEW OF PALAEOBOTANY AND PALYNOLOGY
REV PH CH J	REVIEW OF PHYSICAL CHEMISTRY OF JAPAN
REV PHYS AP	REVUE DE PHYSIQUE APPLIQUEE
REV PO QUIM	REVISTA PORTUGUESA DE QUIMICA
REV RHUM	REVUE DU RHUMATISME ET DES MALADIES OSTEO-ARTICULAIRES
REV RO BIOC	REVUE ROUMAINE DE BIOCHIMIE
REV RO CHIM	REVUE ROUMAINE DE CHIMIE
REV RO PHYS	REVUE ROUMAINE DE PHYSIQUE
REV SCI INS	REVIEW OF SCIENTIFIC INSTRUMENTS
REV ZOO AGR	REVUE DE ZOOLOGIE AGRICOLE ET DE PATHOLOGIE VEGETALE
RIC MAT	RICERCHÉ DI MATEMATICA
RIV ITAL GE	RIVISTA ITALIANA DI GEOFISICA
RIV MED AER	RIVISTA DI MEDICINA AERONAUTICA E SPAZIALE
RIV METEO A	RIVISTA DI METEOROLOGIA AERONAUTICA
ROCZN CHEM	ROCZNIKI CHEMII
RUBBER AGE	RUBBER AGE
RUSS EN J R	RUSSIAN ENGINEERING JOURNAL USSR
RUSS MET R	RUSSIAN METALLURGY METALLY USSR
S AFR J SCI	SOUTH AFRICAN JOURNAL OF SCIENCE
S AFR MED J	SOUTH AFRICAN MEDICAL JOURNAL
SABOURAUDIA	SABOURAUDIA
SARSIA	SARSIA
SB LEKAR	SBORNIK LEKARSKY
SC J CL INV	SCANDINAVIAN JOURNAL OF CLINICAL AND LABORATORY INVESTIGATION
SC J DENT R	SCANDINAVIAN JOURNAL OF DENTAL RESEARCH
SC J GASTR	SCANDINAVIAN JOURNAL OF GASTROENTEROLOGY
SC J HAEMAT	SCANDINAVIAN JOURNAL OF HAEMATOLOGY
SC J IMMUN	SCANDINAVIAN JOURNAL OF IMMUNOLOGY
SC J PLAST	SCANDINAVIAN JOURNAL OF PLASTIC AND RECONSTRUCTIVE SURGERY
SC J PSYCHO	SCANDINAVIAN JOURNAL OF PSYCHOLOGY
SC J RESP D	SCANDINAVIAN JOURNAL OF RESPIRATORY DISEASES
SC J UROL N	SCANDINAVIAN JOURNAL OF UROLOGY AND NEPHROLOGY
SCHW MED WO	SCHWEIZERISCHE MEDIZINISCHE WOCHENSCHRIFT
SCI AM	SCIENTIFIC AMERICAN
SCI FORUM	SCIENCE FORUM
SCI HORT	SCIENTIFIC HORTICULTURE
SCI LIGHT	SCIENCE OF LIGHT
SCI PROGR	SCIENCE PROGRESS
SCI R TOH A	SCIENCE REPORTS OF THE RESEARCH INSTITUTES, TOHOKU UNIVERSITY, SERIES A, PHYSICS, CHEMISTRY AND METALLURGY
SCI SINICA	SCIENTIA SINICA
SCI STUD	SCIENCE STUDIES
SCIENCE	SCIENCE
SCIENTIA	SCIENTIA
SCOT MED J	SCOTTISH MEDICAL JOURNAL
SCRIP MATH	SCRIPTA MATHEMATICA

ISI ABBREVIATION	FULL TITLE
SCRIP METAL	SCRIPTA METALLURGICA
SEA FRONT	SEA FRONTIERS
SEARCH	SEARCH
SEDIMENT GE	SEDIMENTARY GEOLOGY
SEDIMENTOL	SEDIMENTOLOGY
SEIKAGAKU	SEIKAGAKU
SEM HEMATOL	SEMINARS IN HEMATOLOGY
SEM HOP PAR	SEMAINE DES HOPITAUX
SEM ROENTG	SEMINARS IN ROENTGENOLOGY
SEP PURIF M	SEPARATION AND PURIFICATION METHODS
SEPARAT SCI	SEPARATION SCIENCE
SIAM J A MA	SIAM JOURNAL ON APPLIED MATHEMATICS
SIAM J CONT	SIAM JOURNAL ON CONTROL
SIAM J MATH	SIAM JOURNAL ON MATHEMATICAL ANALYSIS
SIAM J NUM	SIAM JOURNAL ON NUMERICAL ANALYSIS
SIAM REV	SIAM REVIEW
SID J	SID JOURNAL
SILIKATY	SILIKATY
SIMULATION	SIMULATION
SKY TELESC	SKY AND TELESCOPE
SOAP COSMET	SOAP COSMETICS CHEMICAL SPECIALTIES
SOC PET E J	SOCIETY OF PETROLEUM ENGINEERS JOURNAL
SOCIAL BIOL	SOCIAL BIOLOGY
SOCIAL PSY	SOCIAL PSYCHIATRY
SOCIAL SC M	SOCIAL SCIENCE AND MEDICINE
SOCIOMETRY	SOCIOMETRY
SOIL BIOL B	SOIL BIOLOGY AND BIOCHEMISTRY
SOIL CONS	SOIL CONSERVATION
SOIL SCI	SOIL SCIENCE
SOIL SCI SO	SOIL SCIENCE SOCIETY OF AMERICA PROCEEDINGS
SOL ST COMM	SOLID STATE COMMUNICATIONS
SOL ST ELEC	SOLID STATE ELECTRONICS
SOL ST TECH	SOLID STATE TECHNOLOGY
SOLAR ENERG	SOLAR ENERGY
SOLAR PHYS	SOLAR PHYSICS
SOUTH MED J	SOUTHERN MEDICAL JOURNAL
SOV J NUC R	SOVIET JOURNAL OF NUCLEAR PHYSICS USSR
SOV MED	SOVETSKAYA MEDITSINA
SOV NEUR R	SOVIET NEUROLOGY AND PSYCHIATRY, USSR
SOV PH AC R	SOVIET PHYSICS ACOUSTICS, USSR
SOV PH SE R	SOVIET PHYSICS SEMICONDUCTORS, USSR
SOV PSYCO R	SOVIET PSYCHOLOGY, USSR
SOV SOIL R	SOVIET SOIL SCIENCF, USSR
SPACE SCI R	SPACE SCIENCE REVIEWS
SPACEFLIGHT	SPACEFLIGHT
SPECIAL LIB	SPECIAL LIBRARIES
SPECT ACT A	SPECTROCHIMICA ACTA PART A MOLECULAR SPECTROSCOPY
SPECT ACT B	SPECTROCHIMICA ACTA PART B ATOMIC SPECTROSCOPY
SPECT LETT	SPECTROSCOPY LETTERS
STAHL EISEN	STAHL UND EISEN
STAIN TECH	STAIN TECHNOLOGY
STARKE	STARKE
STEEL USSR	STEEL IN THE USSR
STEROID LIP	STERIODS AND LIPIDS RESEARCH
STERIODS	STERIODS

ISI ABBREVIATION	FULL TITLE
STRAHLENTHE	STRAHLENTHERAPIE
STU CER FIZ	STUDI SI CERCETARI DE FIZICA
STUD APPL M	STUDIES IN APPLIED MATHEMATICS
STUD BIOPHY	STUDIA BIOPHYSICA
STUD GEOPH	STUDIA GEOPHYSICA ET GEOAETICA
STUD MATH	STUDIA MATHEMATICA
SUB-CELL BI	SUB-CELLULAR BIOCHEMISTRY
SUGAR J	SUGAR JOURNAL
SUMITOMO SE	SUMITOMO SEARCH
SUPP PR T P	SUPPLEMENT OF THE PROGRESS OF THEORETICAL PHYSICS
SURF SCI	SURFACE SCIENCE
SURG CL NA	SURGICAL CLINICS OF NORTH AMERICA
SURG GYN OB	SURGERY GYNECOLOGY AND OBSTETRICS WITH INTERNATIONAL ABSTRACTS OF SURGERY
SURG ITAL	SURGERY ITALY
SURGERY	SURGERY
SVENS PAP T	SVENSK PAPPERSTIDNING
SYM BOT UPS	SYMBOLAE BOTANICAE UPSALIENSES
SYN REAC IN	SYNTHESIS AND REACTIVITY IN ORGANIC AND METAL ORGANIC CHEMISTRY
SYNTHESIS	SYNTHESIS INTERNATIONAL JOURNAL OF METHODS IN SYNTHETIC ORGANIC CHEMISTRY
SYST ZOO	SYSTEMATIC ZOOLOGY
T AM FISH S	TRANSACTIONS OF THE AMERICAN FISHERIES SOCIETY
T AM GEOPHY	TRANSACTIONS AMERICAN GEOPHYSICAL UNION
T AM MATH S	TRANSACTIONS OF THE AMERICAN MATHEMATICAL SOCIETY
T AM MICROS	TRANSACTIONS OF THE AMERICAN MICROSCOPICAL SOCIETY
T AM NUCL S	TRANSACTIONS OF THE AMERICAN NUCLEAR SOCIETY
T AM S ART	TRANSACTIONS AMERICAN SOCIETY FOR ARTIFICIAL INTERNAL ORGANS
T ASAE	TRANSACTIONS OF THE ASAE
T BR MYCOL	TRANSACTIONS OF THE BRITISH MYCOLOGICAL SOCIETY
T IRON ST I	TRANSACTIONS OF THE IRON AND STEEL INSTITUTE OF JAPAN
T J BR CER	TRANSACTIONS AND JOURNAL OF THE BRITISH CERAMIC SOCIETY
T JAP I MET	TRANSACTIONS OF THE JAPAN INSTITUTE OF METALS
T NY AC SCI	TRANSACTIONS OF THE NEW YORK ACADEMY OF SCIENCES
T ROY ENT S	TRANSACTIONS OF THE ROYAL ENTOMOLOGICAL SOCIETY OF LONDON
T ROY SOC C	TRANSACTIONS OF THE ROYAL SOCIETY OF CANADA
T RS S AFR	TRANSACTIONS OF THE ROYAL SOCIETY OF SOUTH AFRICA
T RS TROP M	TRANSACTIONS OF THE ROYAL SOCIETY OF TROPICAL MEDICINE AND HYGIENE
T SOC RHEOL	TRANSACTIONS OF THE SOCIETY OF RHEOLOGY
T WISC AC	TRANSACTIONS OF THE WISCONSIN ACADEMY OF SCIENCES, ARTS AND LETTERS
T I T J LIF	T I T JOURNAL OF LIFE SCIENCES
TALANTA	TALANTA
TAPPI	TAPPI
TASM J AGR	TASMANIAN JOURNAL OF AGRICULTURE
TEC MIT K F	TECHNISCHE MITTEILUNGEN KRUPP FORSCHUNGSBERICHTE
TEC MIT K W	TECHNISCHE MITTEILUNGEN KRUPP WERKSBERICHTE
TECHNOL REV	TECHNOLOGY REVIEW
TECHNOMET	TECHNOMETRICS
TECTONOPHYS	TECTONOPHYSICS

ISI ABBREVIATION	FULL TITLE
TEL RAD E R	TELECOMMUNICATIONS AND RADIO ENGINEERING USSR
TELECOMM J	TELECOMMUNICATION JOURNAL
TELLUS	TELLUS
TENSOR	TENSOR
TEOR VERDYA	TEORIYA VEROYATNOSTEI I YEYE PRIMENENIYA
TERATOLOGY	TERATOLOGY
TETRAHEDR L	TETRAHEDRON LETTERS
TETRAHEDRON	TETRAHEDRON
TEX J SCI	TEXAS JOURNAL OF SCIENCE
TEX REP BID	TEXAS REPORTS BIOLOGY AND MEDICINE AND SUPPLEMENT
TEXT I IND	TEXTILE INSTITUTE AND INDUSTRY
TEXT RES J	TEXTILE RESEARCH JOURNAL
TEXTILVERED	TEXTILVEREDLUNG
THEOR A GEN	THEORETICAL AND APPLIED GENETICS
THEOR CHIM	THEORETICA CHIMICA ACTA
THEOR POP B	THEORETICAL POPULATION BIOLOGY
THERAPIE	THERAPIE
THERM ENG R	THERMAL ENGINEERING USSR
THIN FILMS	THIN FILMS
THIN SOL FI	THIN SOLID FILMS
THORAX	THORAX
THROMB DIAT	THROMBOSIS ET DIATHESIS HAEMORRHAGICA
THROMB RES	THROMBOSIS RESEARCH
TISSUE ANTI	TISSUE ANTIGENS
TISSUE CELL	TISSUE & CELL
TOH J EX ME	TOKYO JOURNAL OF EXPERIMENTAL MEDICINE
TOX APPL PH	TOXICOLOGY AND APPLIED PHARMACOLOGY
TOXICOLOGY	TOXICOLOGY
TOXICON	TOXICON
TRAFFIC Q	TRAFFIC QUARTERLY
TRANSFUSION	TRANSFUSION
TRANSP EN J	TRANSPORTATION ENGINEERING JOURNAL OF ASCE
TRANSP RES	TRANSPORTATION RESEARCH
TRANSP THEO	TRANSPORT THEORY AND STATISTICAL PHYSICS
TRANSPLAN P	TRANSPLANTATION PROCEEDINGS
TRANSPLAN R	TRANSPLANTATION REVIEWS
TRANSPLANT	TRANSPLANTATION
TRAV HUMAIN	TRAVAIL HUMAIN
TROP AGR	TROPICAL AGRICULTURE
TROP GEU ME	TROPICAL AND GEOGRAPHICAL MEDICINE
TROP SCI	TROPICAL SCIENCE
TROPENMED P	TROPENMEDIZIN UND PARASITOLOGIE
TSITOLOGIYA	TSITOLOGIYA
TUMORI	TUMORI
TURRIALBA	TURRIALBA
UAR J CHEM	UNITED ARAB REPUBLIC JOURNAL OF CHEMISTRY
UKR BOKHIM	UKRAINSKII BOKHIMICHESKII ZHURNAL
UKR KHIM ZH	UKRAINSKII KHIMICHESKII ZHURNAL
ULTRASONICS	ULTRASONICS
UN MED CAN	UNION MEDICALE DU CANADA
UNESCO B LI	UNESCO BULLETIN FOR LIBRARIES
UPSAL J MED	UPSALA JOURNAL OF MEDICAL SCIENCES
UROL INTERN	UROLOGIA INTERNATIONALIS
UROLOGE	UROLOGE

ISI ABBREVIATION	FULL TITLE
USBSFW R	UNITED STATES BUREAU OF SPORT FISHERIES AND WILDLIFE RESEARCH REPORT
USP FIZ NAU	USPEKHI FIZICHESKIKH NAUK
USP KH	USPEKHI KHIMII
V MOSK U KH	VESTNIK MOSKOVSKOGO UNIVERSITETA SERIYA KHIMIYA
VACUUM	VACUUM
VAKUUM-TECH	VAKUUM-TECHNIK
VAN SSSR	VESTNIK AKADEMII NAUK SSSR
VET MED/SAC	VETERINARY MEDICINE/SMALL ANIMAL CLINICIAN
VET PATH	VETERINARY PATHOLOGY
VET REC	VETERINARY RECORD
VIDE	VIDE
VIE MILIE A	VIE ET MILIEU SERIE A BIOLOGIE MARINE
VIE MILIE B	VIE ET MILIEU SERIE B OCEANOGRAPHIE
VIE MILIE C	VIE ET MILIEU SERIE C BIOLOGIE TERRESTRE
VIRCH ARC A	VIRCHOWS ARCHIV ABTEILUNG A PATHOLOGISCHE ANATOMIE
VIRCH ARC B	VIRCHOWS ARCHIV ABTEILUNG B ZELL-PATHOLOGIE
VIROLOGY	VIROLOGY
VISION RES	VISION RESEARCH
VOP MED KH	VOPROSY MEDITSINSKOI KHIMII
VOP VIRUSOL	VOPROSY VIRUSOLOGII
VOX SANGUIN	VOX SANGUINIS
VYSO SOED A	VYSOKOMOLEKULYARNYE SOEDINENIYA SECTION A
VYSO SOED B	VYSOKOMOLEKULYARNYE SOEDINENIYA SECTION B
W ROUX ARCH	WILHELM ROUX ARCHIV FUR ENTWICKLUNGSMECHANIK DER ORGANISMEN
WATER RES	WATER RESEARCH
WATER RES R	WATER RESOURCES RESEARCH
WATER SERV	WATER SERVICES
WATER WASTE	WATER AND WASTES ENGINEERING
WEAR	WEAR
WEED RES	WEED RESEARCH
WEED SCI	WEED SCIENCE
WELD PROD R	WELDING PRODUCTION
WELD RES C	WELDING RESEARCH COUNCIL BULLETIN
WELDING J	WELDING JOURNAL
WEST ELEC E	WESTERN ELECTRIC ENGINEER
WEST J MED	WESTERN JOURNAL OF MEDICINE
WHO CHRON	WHO CHRONICLE
WIEN KLIN W	WIENER KLINISCHE WOCHENSCHRIFT
WILSON B	WILSON BULLETIN
WIRE	WIRE
WIREL WORLD	WIRELESS WORLD
WOOD SCI TE	WOOD SCIENCE AND TECHNOLOGY
WORLD OIL	WORLD OIL
WORLD POULT	WORLDS POULTRY SCIENCE JOURNAL
WT Z IND FE	WERKSTATTSTECHNIK ZEITSCHRIFT FUR INDUSTRIELLE FERTIGUNG
X-RAY SPECT	X-RAY SPECTROMETRY
XENOBIOTICA	XENOBIOTICA
YAKUGAKU ZA	YAKUGAKU ZASSHI
YALE J BIOL	YALE JOURNAL OF BIOLOGY AND MEDICINE
YON ACT MED	YONAGO ACTA MEDICA
Z ALLG MIKR	ZEITSCHRIFT FUR ALLGEMEINE MIKROBIOLOGIE

ISI ABBREVIATION	FULL TITLE
Z ANAL CHEM	ZEITSCHRIFT FUR ANALYTISCHE CHEMIE FRESENIUS
Z ANAT ENTW	ZEITSCHRIFT FUR ANATOMIE UND ENTWICKLUNGSGESCHICHTE
Z ANG GEOL	ZEITSCHRIFT FUR ANGEWANDTE GEOLOGIE
Z ANG MA ME	ZEITSCHRIFT FUR ANGEWANDTE MATHEMATIK UND MECHANIK
Z ANG MATH	ZEITSCHRIFT FUR ANGEWANDTE MATHEMATIK UND PHYSIK
Z ANORG A C	ZEITSCHRIFT FUR ANORGANISCHE UND ALLGEMEINE CHEMIE
Z CHEM	ZEITSCHRIFT FUR CHEMIE
Z ERNAHRUNG	ZEITSCHRIFT FUR ERNAHRUNGSWISSENSCHAFT UND SUPPLEMENTA
Z EXP A PSY	ZEITSCHRIFT FUR EXPERIMENTELLE UND ANGEWANDTE PSYCHOLOGIE
Z FLUGWISS	ZEITSCHRIFT FUR FLUGWISSENSCHAFTEN
Z GASTROENT	ZEITSCHRIFT FUR GASTROENTEROLOGIE
Z IMMUN EXP	ZEITSCHRIFT FUR IMMUNITATS-FORSCHUNG EXPERIMENTELLE UND KLINISCHE IMMUNOLOGIE
Z KARDIOL	ZEITSCHRIFT FUR KARDIOLOGIE
Z KIND CH G	ZEITSCHRIFT FUR KINDERCHIRURGIE UND GRENZGEBIETE
Z KINDERHEI	ZEITSCHRIFT FUR KINDERHEILKUNDE
Z KLIN CHEM	ZEITSCHRIFT FUR KLINISCHE CHEMIE UND KLINISCHE BIOCHEMIE
Z KREBSF KL	ZEITSCHRIFT FUR KREBSFORSCHUNG UND KLINISCHE ONKOLOGIE
Z KRISTALL	ZEITSCHRIFT FUR KRISTALLOGRAPHIE, KRISTALLGEOMETRIE, KRISTALLPHYSIK, KRISTALLCHEMIE
Z LEBENSMIT	ZEITSCHRIFT FUR LEBENSMITTEL: UNTERSUCHUNG UND-FORSCHUNG
Z MATH LOG	ZEITSCHRIFT FUR MATHEMATISCHE LOGIK UND GRUNDLAGEN DER MATHEMATIK
Z METALLKUN	ZEITSCHRIFT FUR METALLKUNDE
Z METEOROL	ZEITSCHRIFT FUR METEOROLOGIE
Z MORPH TIE	ZEITSCHRIFT FUR MORPHOLOGIE DER TIERE
Z NATURFO A	ZEITSCHRIFT FUR NATURFORSCHUNG PART A ASTROPHYSIK, PHYSIK UND PHYSIKALISCHE CHEMIE
Z NATURFO B	ZEITSCHRIFT FUR NATURFORSCHUNG PART B CHEMIE, BIOCHEMIE, BIOPHYSIK, BIOLOGIE UND VERWANDTEN GEBIETE
Z NATURFO C	ZEITSCHRIFT FUR NATURFORSCHUNG PART C BIOCHEMIE, BIOPHYSIK, BIOLOGIE, VIROLOGIE
Z ORTHOP GR	ZEITSCHRIFT FUR ORTHOPADIE UND IHRE GRENZGEBIETE
Z PARASITEN	ZEITSCHRIFT FUR PARASITENKUNDE
Z PFLANZENP	ZEITSCHRIFT FUR PFLANZENPHYSIOLOGIE
Z PFLANZENZ	ZEITSCHRIFT FUR PFLANZENZUCHTUNG
Z PHYS	ZEITSCHRIFT FUR PHYSIK
Z PHYS CH F	ZEITSCHRIFT FUR PHYSIKALISCHE CHEMIE FRANKFURT
Z PHYS CH L	ZEITSCHRIFT FUR PHYSIKALISCHE CHEMIE LEIPZIG
Z RECHTSMED	ZEITSCHRIFT FUR RECHTSMEDIZIN JOURNAL OF LEGAL MEDICINE
Z RHEUMATOL	ZEITSCHRIFT FUR RHEUMATOLOGIE
Z VERS KUND	ZEITSCHRIFT FUR VERSUCHSTIER KUNDE
Z WAHRSCH V	ZEITSCHRIFT FUR WAHRSCHEINLICHKEITSTHEORIE UND VERWANDTE GEBIETE
ZAVOD LAB	ZAVODSKAYA LABORATORIYA

ISI ABBREVIATION	FULL TITLE
ZBL BAKT A	ZENTRALBLATT FÜR BAKTERIOLOGIE PARASITENKUNDE, INFektions- KRANKHEITEN UND HYGIENE ERSTE ABTEILUNG ORIGINALE, REIHE A
ZBL BAKT B	ZENTRALBLATT FÜR BAKTERIOLOGIE PARASITENKUNDE, INFektions- KRANKHEITEN UND HYGIENE ERSTE ABTEILUNG ORIGINALE, REIHE B
ZBL VET A	ZENTRALBLATT FÜR VETERINÄRMEDIZIN REIHE A
ZBL VET B	ZENTRALBLATT FÜR VETERINÄRMEDIZIN REIHE B
ZELL PAPIER	ZELLSTOFF UND PAPIER
ZH ANAL KH	ZHURNAL ANALITICHESKOI KHIMII
ZH EKSP TEO	ZHURNAL EKSPERIMENTAL'NOI I TEORETICHESKOI FIZIKI
ZH FIZ KHIM	ZHURNAL FIZICHESKOI KHIMII
ZH MIKROB E	ZHURNAL MIKROBIOLOGII EPIDEMIOLOGII I IMMUNOBIOLOGII
ZH NEORG KH	ZHURNAL NEORGANICHESKOI KHIMII
ZH NP FOTOG	ZHURNAL NAUCHNOI I PRIKLADNOI FOTOGRAFII I KINEMATOGRAFII
ZH OBS BIOL	ZHURNAL OBSHCHEI BIOLOGII
ZH OBS KH	ZHURNAL OBSHCHEI KHIMII
ZH ORG KH	ZHURNAL ORGANICHESKOI KHIMII
ZH PRIK KH	ZHURNAL PRIKLADNOI KHIMII
ZH STRUK KH	ZHURNAL STRUKTURNOI KHIMII
ZH TEKH FIZ	ZHURNAL TEKHNICHESKOI FIZIKI
ZH VYSS MER	ZHURNAL VYSSHOI NERVNOI DEYATEL- NOSTI IMUNI I P. PAVLOVA
ZOOL J LINN	ZOOLOGICAL JOURNAL OF THE LINNEAN SOCIETY
ZOOL SCR	ZOOLOGICA SCRIPTA

